











36 060 809



- Abdeckplatte 80 x 80 mm
Passt zu VAIA

Passt zu VAIA

	Messing gebürstet (23kt Gold)	36 060 809-28
	Chrom	36 060 809-00
	Platin gebürstet	36 060 809-06
	Platin	36 060 809-08
	Dark Chrome	36 060 809-19
	Light Gold gebürstet	36 060 809-27
	Bronze gebürstet	36 060 809-42
	Champagne gebürstet (22kt Gold)	36 060 809-46
	Champagne (22kt Gold)	36 060 809-47
	Dark Platinum gebürstet	36 060 809-99

Benötigtes Zubehör



- UP-Wand-Einhandbatterie -** 35 860 970 90
- Max. Einbautiefe 95 mm
 - Min. Einbautiefe 80 mm



VAIA UP-Einhandbatterie mit Abdeckplatte - Messing gebürstet (23kt Gold)

VAIA

36 060 809

Codes & Standards

DIN 4109

ISO 3822

Ü-Zeichen

Zertifikate

LGA_29

36 060 809

Produktversion von 4/1/2024

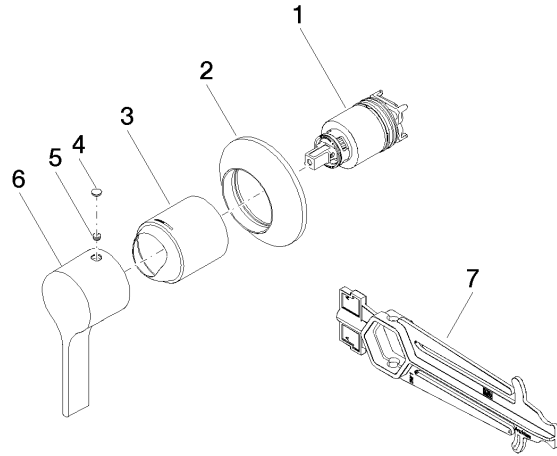



VAIA UP-Einhandbatterie mit Abdeckplatte - Messing gebürstet (23kt Gold)

VAIA

36 060 809

Ersatzteilstückliste

Produktversion von 4/1/2024

Nr.	Artikelnummer	Benennung	Verbaumenge	Lieferzeit
	90 15 05 064 01 90	Kartusche mit Adapterplatte Ø 35 mm x 58,6 mm -	7	2