

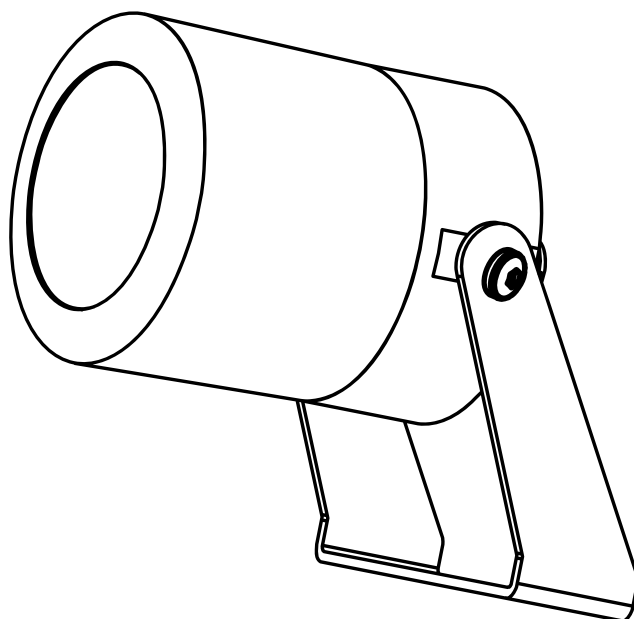

Read these instructions & save for future use

Garden spot | 104x67x92mm | 40° | 8W | black | 2700K | dim



Article number **149-355**

Brand **Tronix Lighting**

Type **Garden lighting**

Contents of this product **1x garden spot 8W 2700K**

Technical datasheet **Digitally available
on our webshop**



*View instructions and
technical data also on
our website*

TRONIX



Before first use

Before getting started with this product, it is advisable to check the order completeness and any damage. If this is the case, please contact Tronix Lighting.

Description

This garden spot has a beam angle of 40° and can be directed up to 180°. Due to its warm light color (2700K), this spotlight is perfect for highlighting trees, facades, shrubs or other outdoor objects.

Features

- Rotate 180° around;
- Easy to mount with included mounting bracket;
- Can be placed in the ground with ground pin 149-352;
- Plug&Play with 200 cm long cable and Schuko plug.

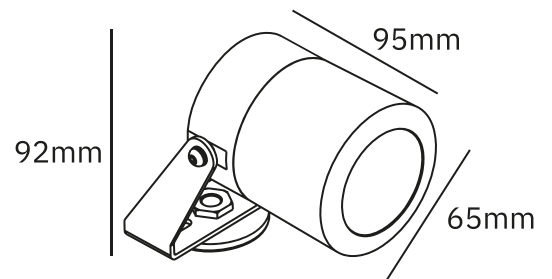

Installation

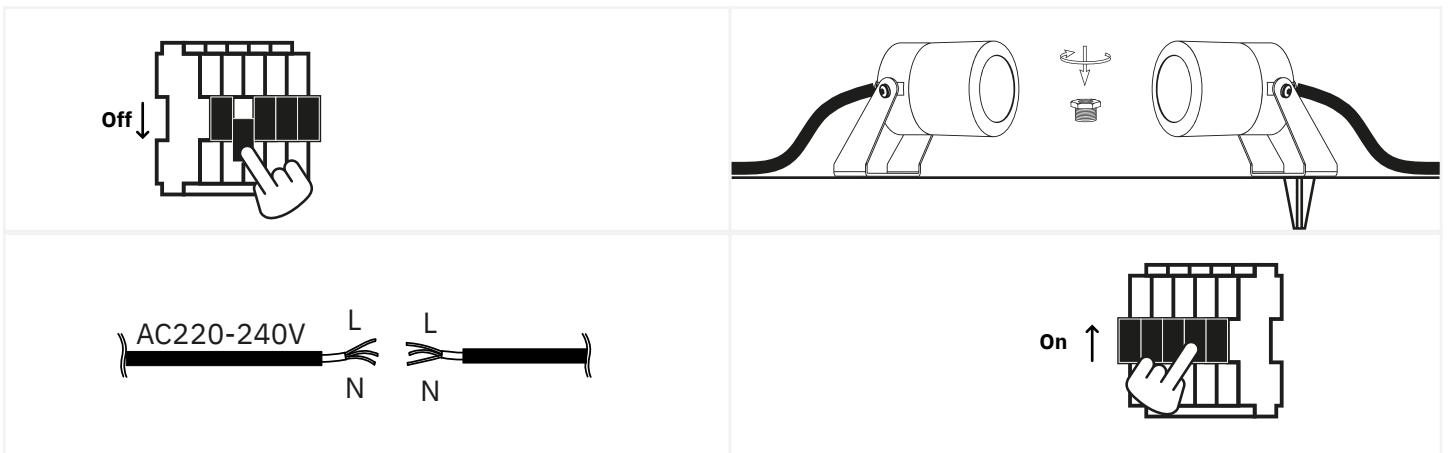

1. Turn off the power, remove the product and associated parts from their packaging and check the wiring present before installation;
2. Place the garden spot in the predetermined location. This can also be done with the optional pin 149-352;
3. Attach the garden spot to the chosen location and connect the wiring to the existing (ground)cable.
4. Check the complete installation after the garden spot is installed. Should it be in order, the mains power can be reactivated.



Safety

Safety is a top priority at Tronix Lighting. Therefore, we heartily recommend that you follow the following steps closely:

- Keep this manual carefully for future reference;
- Choose a qualified electrician while installing, maintaining or inspecting this product;
- Never look directly into a light source to avoid possible damage to the eye;
- Always ensure that the relevant power group is on non-active when the product is connected;
- Use only recommended combinations (LED drivers, controllers or dimmers) to avoid injury or damage to the product.

Technical problems and repair

Should a product not work properly after installation, or if the product exhibits problems over time, it is advisable to check the following elements:

- Check the wiring and installation of your product;
- Check for the presence of disruptive elements such as dust, water or other electronics;
- Should it be possible, try disconnecting the product and testing it in another location to rule out a problem at the location;

Should you be dealing with a WIFI-based product, check and reset your router's settings.

Should the product still not work after testing, it is recommended to send it in for inspection and/or repair. To do so, please contact Tronix Lighting using nearby details and proof of purchase (packing slip).



CARE



SHARE



CONNECT

Supplier:

Tronix Lighting B.V

Vluchtoord 41
5406 XP Uden, Netherlands

+31 (0)413 330 380
sales@tronixlighting.com

Terms and symbols (as relevant to product)



The **CE mark** indicates that this product complies with EU regulations on safety, health and environmental protection;



The **WEEE symbol** stands for "Waste Electrical and Electronic Equipment Regulation," a directive on the collection, recycling and recovery of electronic waste;



The **Class I symbol** indicates that this product is protected by means of the additional ground cable. This cable is identified by the yellow/green jacket and is attached to this product.

- This product has an **IP65 rating**. This means the housing is touch-safe, fully protected from dust and spray-proof (12.5 L/min) regardless of angle.