

Product: SpiroTrap Rp1 1/2" Universal Threaded fitting

Type:

UE150WJ

Datum:

12-11-2024

Klantnaam:

Project:

Referentie:

Ontwerp criteria

Medium:	Water / glycol (max.50%)	
Max. Stroomingssnelheid:	1	m/s
Maximum debiet:	5,00	m ³ /h
Maximale systeemdruk:	10	bar-g
Maximale temperatuur:	110	°C
Ontwerpstandaard:	EN 13445	

Kwaliteitscontrole

Lektest:	nee
Testcertificaat:	nee
Ontwerp en Productie volgens 2014/68/EU:	ja
Materiaalcertificaten:	nee
Tekening:	nee

Constructiematerialen

Huis:	Messing
Swivel:	Messing
Aftapkraan:	Messing
Spirobuis Kernbuis:	Koper
Spirobuis Beharing:	Koper
Spirobuis Soldeer:	Tin(SnCu3)
Magneet:	Neodymium

Tekening

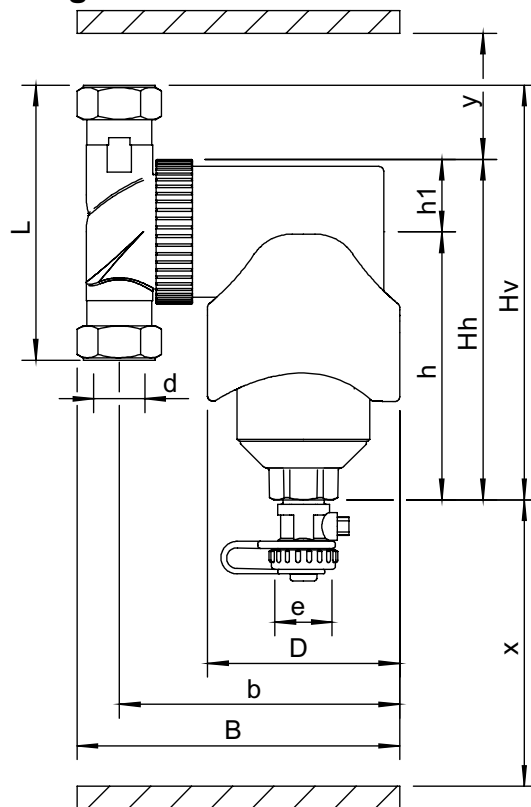

Afmetingen

d:	Rp1 1/2"
h:	160 mm
Hh:	210 mm
Hv:	224 mm
h1:	50 mm
L:	128 mm
D:	84 mm
B:	168 mm
b:	141 mm
x:	>110 mm
y:	>50 mm
e:	G3/4

Volume	0,75 ltr
Ledig gewicht (circa)	3,7 kg

Wijzigingen voorbehouden