

Data Sheet | Item Number: 899-631/302-000

Distribution box; Three-phase to single-phase current (400 V/230 V); 2 inputs; 6 outputs; Cod. A, P; MIDI; black

<https://www.wago.com/899-631/302-000>

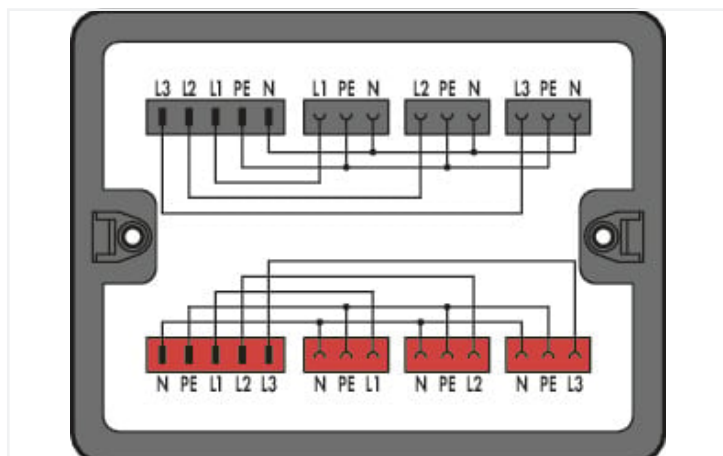

Color: ■ black

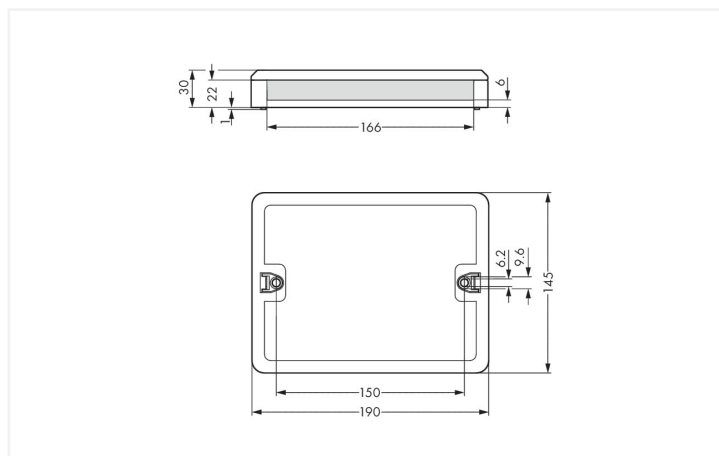

Dimensions in mm

Distribution box *WINSTA*® rated current 25 A

With the distribution box from the *WINSTA*® product line with protection against mismatching, zero-defect installation is guaranteed. With WAGO, you benefit from a large selection of expansions for the *WINSTA*® product line. The coding options reduce installation errors, allowing fast, maintenance-free wiring of all components. The distribution box offers touch-proof protection with live components in accordance with protection type IP20 (When mated: IP2xC (These compact connectors are not designed for use in open, easily accessible areas!)). Standard mains applications for almost any domain of use can be realised with *WINSTA*® distribution boxes with A coding. This distribution box can be used for electrical currents up to 25 A. Thus the product is especially suitable for high power loads.

WINSTA® solutions for your electrical installation – protected against mismatching and maintenance-free

The *WINSTA*® Pluggable Connection System allows pluggable electrical installation. This saves time, lowers costs, and reduces the need for servicing. Take advantage of the pluggable version of our maintenance-free spring pressure connection technology too! Plan your installation with with protection type IP20 from WAGO.

- distribution boxes with protection against mismatching
- clear slot identification for easy commissioning
- products perfectly tailored to your requirements guarantee safe use
- with A coding for a great number of applications
- rapid, structured electrical installation

Electrical data

Ratings per	IEC/EN 60664-1		
Overvoltage category	III	III	II
Pollution degree	3	2	2
Nominal voltage	400 V	-	-
Rated surge voltage	6 kV	-	-
Rated current	25 A	-	-

Ratings per IEC/EN 2	
Rated voltage (III/3) 2	250 V
Rated surge voltage (III/3) 2	4 kV

General information

Note on contact resistance	approx. 1 mΩ contact resistance approx. 0.25 mΩ contact transition (plug/ socket)
----------------------------	---

Physical data

Width	190 mm / 7.48 inches
Height	30 mm / 1.181 inches
Depth	145 mm / 5.709 inches

Mechanical data

Internal wiring	4 mm ²
Application	Three-Phase to Single-Phase Current (400 V/230 V)
Coding	A
Coding 2	P
Mounting type	Wall, screw mount Installation on mounting plate
Protection type	IP20; When mated: IP2xC (These compact connectors are not designed for use in open, easily accessible areas!)

Plug-in connection

Mismating protection	Yes
Note on mismating protection	All <i>WINSTA</i> ® components are 100% protected against mismating when: <ul style="list-style-type: none"> a.) plugging different numbers of poles b.) plugging while rotated 180 c.) plugging while laterally staggered d.) plugging one pole
Locking of plug-in connection	Locking lever

Material data

Note (material data)	Information on material specifications can be found here
Color	black
Insulation material	Polyamide (PA66)
Flammability class per UL94	V0
Contact material	Copper or copper alloy; surface-treated
Contact plating	Tin
Fire load	13.996 MJ
Weight	389.8 g

Environmental requirements

Processing temperature	-5 ... +40 °C
Continuous operating temperature	-35 ... +85 °C
Note on continuous operating temperature	Insulating parts for temperatures ≤ 105 °C

Commercial data

eCl@ss 10.0	27-44-06-03
eCl@ss 9.0	27-44-06-03
ETIM 8.0	EC002567
ETIM 7.0	EC002567
PU (SPU)	1 pcs
Packaging type	Box
Country of origin	DE
GTIN	4055143294157
Customs tariff number	85366990990

Environmental Product Compliance

RoHS Compliance Status	Compliant, No Exemption
------------------------	-------------------------

Downloads

Environmental Product Compliance

Compliance Search	
Environmental Product Compliance 899-631/302-000	↓









Documentation

Bid Text			
899-631/302-000	19.02.2019	xml 3.59 KB	↓
899-631/302-000	23.02.2015	doc 25.50 KB	↓





1 Compatible Products

1.1 System counterpart

1.1.1 Cable assembly

 <p>Item No.: 771-9993/206-101 pre-assembled connecting cable; Eca; Plug/open-ended; 3-pole; Cod. A; H05VV-F 3G 1.5 mm²; 1 m; 1,50 mm²; black</p>	 <p>Item No.: 771-9973/206-101 pre-assembled connecting cable; Eca; Plug/open-ended; 3-pole; Cod. P; H05VV-F 3G 1.5 mm²; 1 m; 1,50 mm²; red</p>	 <p>Item No.: 771-9995/106-101 pre-assembled connecting cable; Eca; Socket/open-ended; 5-pole; Cod. A; H05VV-F 5G 1.5 mm²; 1 m; 1,50 mm²; black</p>	 <p>Item No.: 771-9975/106-101 pre-assembled connecting cable; Eca; Socket/open-ended; 5-pole; Cod. P; H05VV-F 5G 1.5 mm²; 1 m; 1,50 mm²; red</p>
 <p>Item No.: 771-9993/006-101 pre-assembled interconnecting cable; Eca; Socket/plug; 3-pole; Cod. A; H05VV-F 3G 1.5 mm²; 1 m; 1,50 mm²; black</p>	 <p>Item No.: 771-9973/006-101 pre-assembled interconnecting cable; Eca; Socket/plug; 3-pole; Cod. P; H05VV-F 3G 1.5 mm²; 1 m; 1,50 mm²; red</p>	 <p>Item No.: 771-9995/006-101 pre-assembled interconnecting cable; Eca; Socket/plug; 5-pole; Cod. A; H05VV-F 5G 1.5 mm²; 1 m; 1,50 mm²; black</p>	 <p>Item No.: 771-9975/006-101 pre-assembled interconnecting cable; Eca; Socket/plug; 5-pole; Cod. P; H05VV-F 5G 1.5 mm²; 1 m; 1,50 mm²; red</p>

1.1.2 Female connector/socket

 <p>Item No.: 770-205 Socket; 5-pole; Cod. A; 4,00 mm²; black</p>	 <p>Item No.: 770-405 Socket; 5-pole; Cod. A; 4,00 mm²; black</p>	 <p>Item No.: 770-1305 Socket; 5-pole; Cod. P; 4,00 mm²; red</p>	 <p>Item No.: 770-105 Socket; with strain relief housing; 5-pole; Cod. A; 4,00 mm²; black</p>
 <p>Item No.: 770-305 Socket; with strain relief housing; 5-pole; Cod. A; 4,00 mm²; black</p>			

1.1.3 Male connector/plug



Item No.: 770-213

Plug; 3-pole; Cod. A; 4,00 mm²; black



Item No.: 770-1313

Plug; 3-pole; Cod. P; 4,00 mm²; red



Item No.: 770-113

Plug; with strain relief housing; 3-pole;
Cod. A; 4,00 mm²; black



Item No.: 770-213/035-000

Plug; with strain relief housing; 3-pole;
Cod. A; 4,00 mm²; black

1.2 Optional Accessories

1.2.1 Installation

1.2.1.1 Mounting accessories



Item No.: 899-680

Mounting plate; for distribution boxes; gray

Installation Notes

Installation

