

Data Sheet | Item Number: 899-631/180-000

Distribution box; Motion/presence detector; 1 input; 5 outputs; Cod. A; MIDI; black

<https://www.wago.com/899-631/180-000>

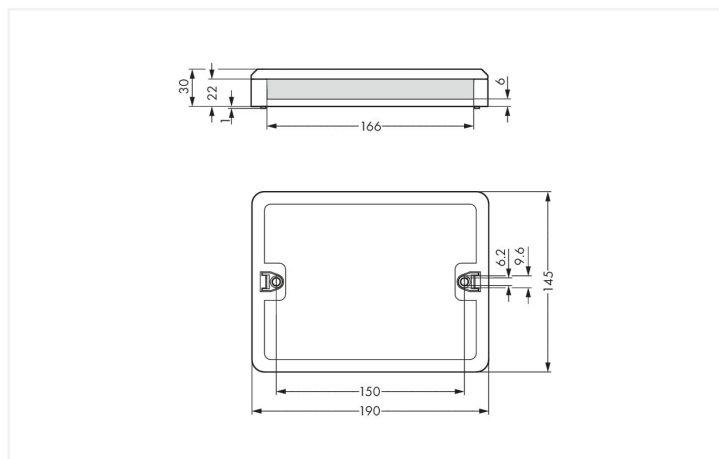
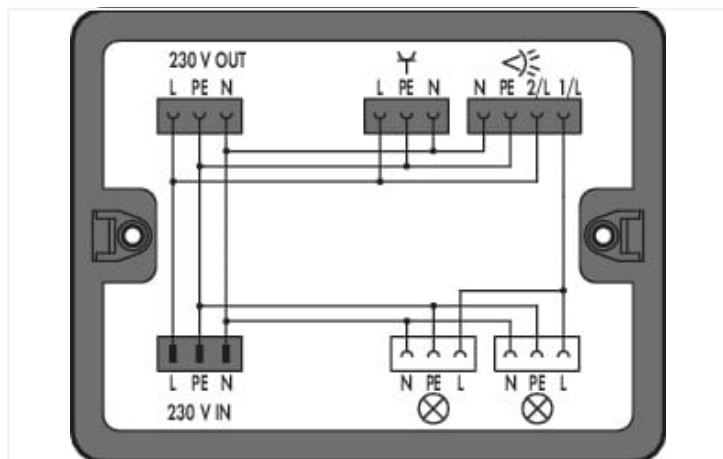

Color: ■ black

Dimensions in mm

Distribution box WINSTA® with protection against mismatching

Choose tried-and-tested accuracy for the electrical installation for the implementation of your project: The distribution box from the WINSTA® product line with a current rating of 25 A. With WAGO, you can enjoy the advantages of a large selection of expansions for the WINSTA® product line. The coding options reduce installation errors, allowing fast, secure wiring of all components. The distribution box is protected against ingress by solid objects in accordance with protection type IP20 (When mated: IP2xC (These compact connectors are not designed for use in open, easily accessible areas!)). The WINSTA® distribution box with A coding in black or white is normally used for general mains applications in power distribution. Important parameters in the selection of a distribution box are the rated current and voltage: They provide information about possible domains of use and applications. This product has a current rating of 25 A – as a result it is also suitable for robust loads.

WINSTA® solutions for your electrical installation – protected against mismatching and maintenance-free

The WINSTA® Pluggable Connection System is perfectly tailored to the very strict requirements of building installation. It makes electrical installation pluggable, and thus more efficient, more reliable, and error-free. Use of this pre-assembled system decreases time spent on assembly and installation errors at the construction site. Take advantage of the pluggable version of our maintenance-free spring pressure connection technology too! Plan your installation with with protection against mismatching from WAGO.

- protection against mismatching eliminates errors
- intuitive marking
- products perfectly tailored to your requirements guarantee safe use
- for any mains application
- quick replacement of defective units during ongoing operation

Electrical data

Ratings per	IEC/EN 60664-1		
Overvoltage category	III	III	II
Pollution degree	3	2	2
Nominal voltage	250 V	-	-
Rated surge voltage	4 kV	-	-
Rated current	25 A	-	-

General information

Note on contact resistance	approx. 1 mΩ contact resistance approx. 0.25 mΩ contact transition (plug/ socket)
----------------------------	--

Physical data

Width	190 mm / 7.48 inches
Height	30 mm / 1.181 inches
Depth	145 mm / 5.709 inches

Mechanical data

Internal wiring	4 mm ²
Application	Motion and Presence Detectors
Coding	A
Mounting type	Wall, screw mount Installation on mounting plate
Protection type	IP20; When mated: IP2xC (These compact connectors are not designed for use in open, easily accessible areas!)

Plug-in connection

Mismating protection	Yes
Note on mismating protection	All <i>WINSTA</i> [®] components are 100% protected against mismating when: a.) plugging different numbers of poles b.) plugging while rotated 180 c.) plugging while laterally staggered d.) plugging one pole
Locking of plug-in connection	Locking lever

Material data

Note (material data)	Information on material specifications can be found here
Color	black
Insulation material	Polyamide (PA66)
Flammability class per UL94	V0
Contact material	Copper or copper alloy; surface-treated
Contact plating	Tin
Fire load	15.216 MJ
Weight	400 g

Environmental requirements

Processing temperature	-5 ... +40 °C
Continuous operating temperature	-35 ... +85 °C
Note on continuous operating temperature	Insulating parts for temperatures ≤ 105 °C

Commercial data

eCl@ss 10.0	27-44-06-03
eCl@ss 9.0	27-44-06-03
ETIM 8.0	EC002567
ETIM 7.0	EC002567
PU (SPU)	1 pcs
Packaging type	Box
Country of origin	DE
GTIN	4055143292993
Customs tariff number	85366990990

Environmental Product Compliance

RoHS Compliance Status	Compliant, No Exemption
------------------------	-------------------------

Downloads

Environmental Product Compliance

Compliance Search	
Environmental Product Compliance 899-631/180-000	↓







Documentation

Bid Text			
899-631/180-000	19.02.2019	xml 3.43 KB	↓
899-631/180-000	11.03.2015	doc 26.00 KB	↓



1 Compatible Products

1.1 System counterpart









1.1.1 Cable assembly

 <p>Item No.: 771-9993/206-101 pre-assembled connecting cable; Eca; Plug/open-ended; 3-pole; Cod. A; H05VV-F 3G 1.5 mm²; 1 m; 1,50 mm²; black</p>	 <p>Item No.: 771-9993/206-102 pre-assembled connecting cable; Eca; Plug/open-ended; 3-pole; Cod. A; H05VV-F 3G 1.5 mm²; 1 m; 1,50 mm²; white</p>	 <p>Item No.: 771-9994/206-101 pre-assembled connecting cable; Eca; Plug/open-ended; 4-pole; Cod. A; H05VV-F 4G 1.5 mm²; 1 m; 1,50 mm²; black</p>	 <p>Item No.: 771-9993/106-101 pre-assembled connecting cable; Eca; Socket/open-ended; 3-pole; Cod. A; H05VV-F 3G 1.5 mm²; 1 m; 1,50 mm²; black</p>
 <p>Item No.: 771-9993/006-101 pre-assembled interconnecting cable; Eca; Socket/plug; 3-pole; Cod. A; H05VV-F 3G 1.5 mm²; 1 m; 1,50 mm²; black</p>	 <p>Item No.: 771-9993/006-102 pre-assembled interconnecting cable; Eca; Socket/plug; 3-pole; Cod. A; H05VV-F 3G 1.5 mm²; 1 m; 1,50 mm²; white</p>	 <p>Item No.: 771-9994/006-101 pre-assembled interconnecting cable; Eca; Socket/plug; 4-pole; Cod. A; H05VV-F 4G 1.5 mm²; 1 m; 1,50 mm²; black</p>	

1.1.2 Female connector/socket

 <p>Item No.: 770-203 Socket; 3-pole; Cod. A; 4,00 mm²; black</p>	 <p>Item No.: 770-103 Socket; with strain relief housing; 3-pole; Cod. A; 4,00 mm²; black</p>	 <p>Item No.: 770-203/035-000 Socket; with strain relief housing; 3-pole; Cod. A; 4,00 mm²; black</p>
--	--	---

1.1.3 Male connector/plug

 <p>Item No.: 770-213 Plug; 3-pole; Cod. A; 4,00 mm²; black</p>	 <p>Item No.: 770-233 Plug; 3-pole; Cod. A; 4,00 mm²; white</p>	 <p>Item No.: 770-214 Plug; 4-pole; Cod. A; 4,00 mm²; black</p>	 <p>Item No.: 770-113 Plug; with strain relief housing; 3-pole; Cod. A; 4,00 mm²; black</p>
 <p>Item No.: 770-213/035-000 Plug; with strain relief housing; 3-pole; Cod. A; 4,00 mm²; black</p>	 <p>Item No.: 770-133 Plug; with strain relief housing; 3-pole; Cod. A; 4,00 mm²; white</p>	 <p>Item No.: 770-233/035-050 Plug; with strain relief housing; 3-pole; Cod. A; 4,00 mm²; white</p>	 <p>Item No.: 770-114 Plug; with strain relief housing; 4-pole; Cod. A; 4,00 mm²; black</p>

1.2 Optional Accessories

1.2.1 Installation

1.2.1.1 Mounting accessories



Item No.: [899-680](#)

Mounting plate; for distribution boxes; gray

Installation Notes

Installation

