

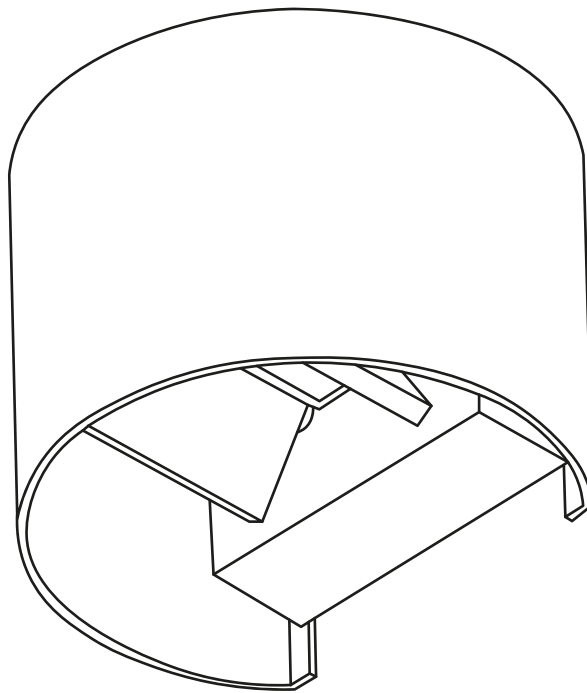

Read these instructions & save for future use

Wall lamp | 136x115x100mm | white | 6W | 2700K | dim



Article number **149-149**

Brand **Tronix Lighting**

Type **Wall lighting**

Contents of this product **1x 6W wall light 2700K**

Technical datasheet **Digitally available
on our webshop**



*View instructions and
technical data also on
our website*

TRONIX



Before first use

Before getting started with this product, it is advisable to check the order completeness and any damage. If this is the case, please contact Tronix Lighting.

Description

This up and down light is not only compact and sturdy, but also provides a unique lighting experience unlike any other. The wall lamp features two independently adjustable angles, allowing you to easily adjust the beam angle.

In addition, this wall light is easy to install using the connector block provided within the fixture.

Features

- High quality CREE LEDs with 50,000 burning hours;
- Ideal for outdoor use thanks to its IP65 rating;
- Adjustable beam angle from 1° to 120°.

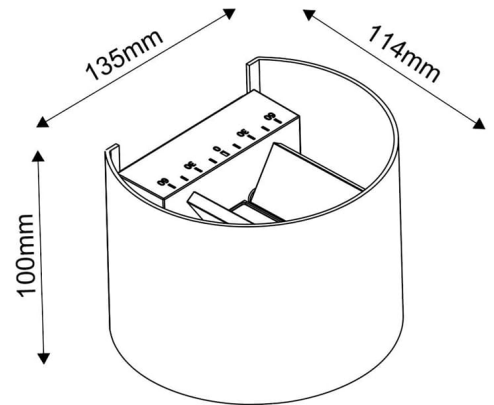

Installation

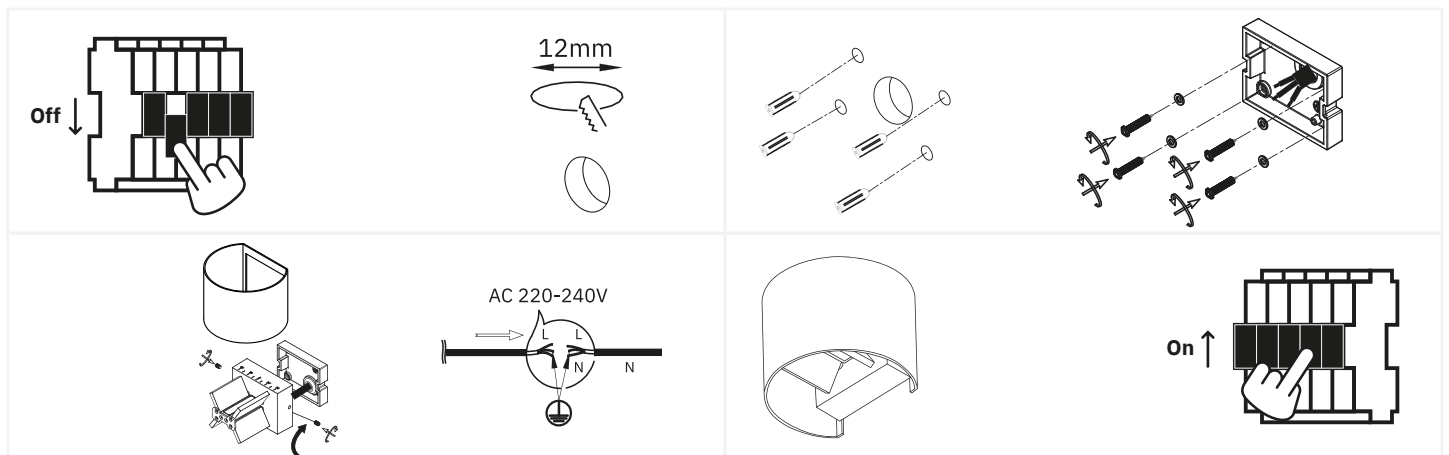

1. Turn off the power and remove the product and associated parts from the packaging. Next, cut a hole approximately 12mm in diameter to mount the wall light on;
2. Drill four holes around the hole and place plugs in these holes. Next, place the back of the frame against the wall and attach it using the screws provided;
3. Place the remaining parts of the wall light and secure them. Attach the wiring of the wall lamp to the mains;
4. Check the installation of the wall lamp. Activate the power when it is okay to complete the installation.



Safety

Safety is a top priority at Tronix Lighting. Therefore, we heartily recommend that you follow the following steps closely:

- Keep this manual carefully for future reference;
- Choose a qualified electrician while installing, maintaining or inspecting this product;
- Never look directly into a light source to avoid possible eye damage;
- Ensure that the respective power group is always on non-active when the product is connected;
- Use only recommended combinations (LED drivers, controllers or dimmers) to avoid injury or damage to the product;
- The light source of this light is not replaceable. Because of this, you must replace the entire fixture towards the end of its lifespan and it is not recommended to open it.

Technical problems and repair

Should a product not work properly after installation, or if the product exhibits problems over time, it is advisable to check the following elements:

- Check the wiring and installation of your product;
- Check for the presence of interfering elements such as dust, water or other electronics;
- If possible, try disconnecting the product and testing it in another location to rule out a problem at the location;
- Should you be dealing with a WIFI-based product, check and reset your router's settings.

Should the product still not work after testing, it is recommended to send it in for inspection and/or repair. To do so, please contact Tronix Lighting using nearby details and proof of purchase (packing slip).



CARE



SHARE



CONNECT

Supplier:

Tronix Lighting B.V

Vluchtoord 41
5406 XP Uden, Netherlands

+31 (0)413 330 380
sales@tronixlighting.com

Terms and symbols (as relevant to product)



The **CE mark** indicates that this product complies with EU regulations on safety, health and environmental protection;



The **WEEE symbol** stands for "Waste Electrical and Electronic Equipment Regulation," a directive on the collection, recycling and recovery of electronic waste;



The **Class I symbol** indicates that this product is protected by means of the additional ground cable. This cable is identified by the yellow/green jacket and is attached to this product.

- This product has an **IP65 rating**. This means the housing is touch-safe, fully protected from dust and spray-proof (12.5 L/min) regardless of angle.