

# Data Sheet | Item Number: 2020-5477/1102-953

4-conductor sensor supply terminal block; LED (green); with ground contact; with pluggable signal level; 1 mm<sup>2</sup>; Push-in CAGE CLAMP®; 1,00 mm<sup>2</sup>; orange

<https://www.wago.com/2020-5477/1102-953>

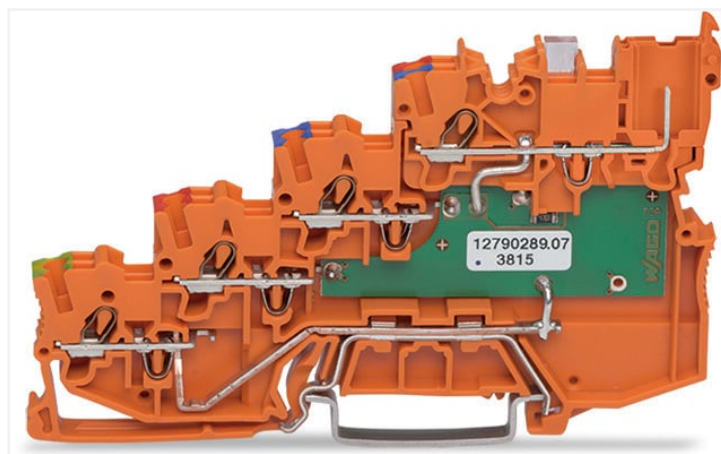
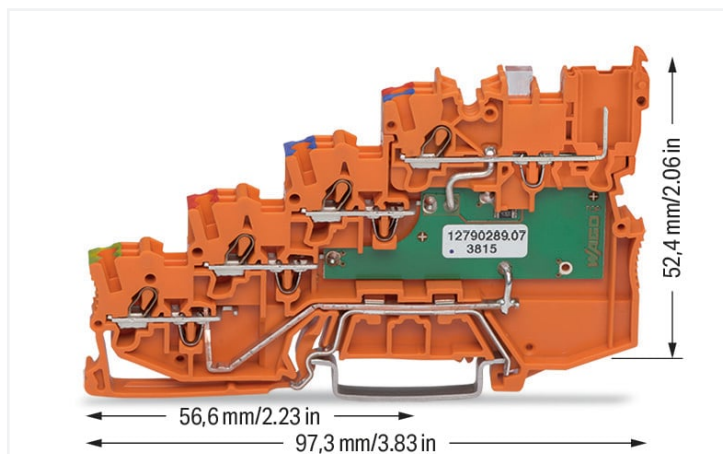

Color: ■ orange

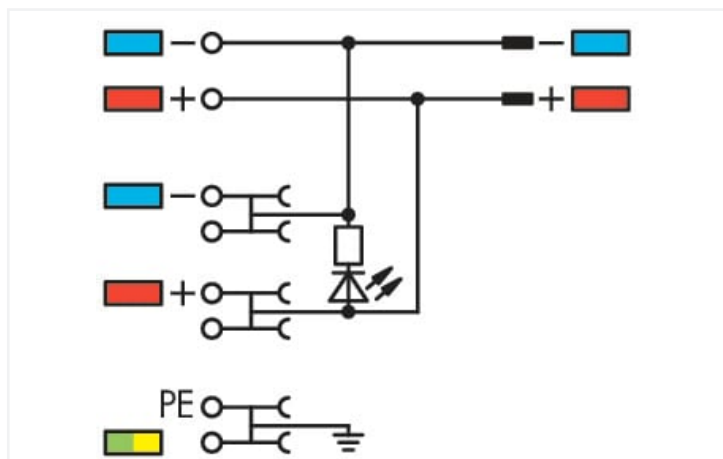

2020-5477/1102-953

3.5 mm spacing per signal (2 x 3.5 mm = 7 mm)

The double spacing per pole of this terminal block series maximizes connectivity. For example, ten sensors may be connected using only five sensor terminal blocks plus a power supply terminal block.

## Notes

Note

According to EN 61984, pluggable connectors without a current interrupting capacity must not be mated or unmated when live or under load. An appropriate end plate must be applied to the carrier terminal blocks after each female plug.

## Electrical data

### Ratings per IEC/EN

Rated current	13.5 A
---------------	--------

### Approvals per

### UL 1059

	B	C	D
Use group	B	C	D
Rated voltage	300 V	-	300 V
Rated current	15 A	-	15 A

Approvals per	CSA 22.2 No 158		
Use group	B	C	D
Rated voltage	-	24 V	-
Rated current	-	10 A	-

Power Loss	
Power loss, per pole (potential)	0.4338 W
Rated current $I_N$ for specified power loss	13.5 A
Resistance value for specified, current-dependent power loss	0.00238 $\Omega$

General information	
Voltage type 1	DC
Nominal voltage	24 V

Connection data	
Connection points	8
Female plug slots	2
Total number of potentials	5
Number of levels	4
Number of jumper slots	4

Connection 1	
Connection technology	Push-in CAGE CLAMP®
Actuation type	Operating tool
Connectable conductor materials	Copper
Nominal cross-section	1 mm <sup>2</sup>
Solid conductor	0.14 ... 1.5 mm <sup>2</sup> / 24 ... 16 AWG
Solid conductor; push-in termination	0.5 ... 1.5 mm <sup>2</sup> / 20 ... 16 AWG
Fine-stranded conductor	0.14 ... 1.5 mm <sup>2</sup> / 24 ... 16 AWG
Fine-stranded conductor; with insulated ferrule	0.14 ... 0.75 mm <sup>2</sup> / 24 ... 18 AWG
Fine-stranded conductor; with ferrule; push-in termination	0.5 ... 0.75 mm <sup>2</sup> / 20 ... 18 AWG
Note (conductor cross-section)	Depending on the conductor characteristic, a conductor with a smaller cross-section can also be inserted via push-in termination.
Strip length	9 ... 11 mm / 0.35 ... 0.43 inches
Wiring direction	Front-entry wiring

Physical data	
Width	7 mm / 0.276 inches
Height	97.3 mm / 3.831 inches
Depth from upper-edge of DIN-rail	52.4 mm / 2.063 inches

Mechanical data	
Mounting type	DIN-35 rail
Marking level	Center/side marking

Material data	
Note (material data)	<a href="https://www.wago.com/us/material-specifications">Information on material specifications can be found here</a>
Color	orange
Material group	I
Insulation material	Polyamide (PA66)
Flammability class per UL94	V0
Fire load	0.32 MJ
Weight	21.6 g

### Environmental requirements

Processing temperature	-35 ... +85 °C
Continuous operating temperature	-60 ... +105 °C

### Commercial data

eCl@ss 10.0	27-14-11-28
eCl@ss 9.0	27-14-11-28
ETIM 8.0	EC000900
ETIM 7.0	EC000900
PU (SPU)	15 pcs
Packaging type	Box
Country of origin	DE
GTIN	4055143525527
Customs tariff number	85369010000

### Environmental Product Compliance

RoHS Compliance Status	Compliant, No Exemption
------------------------	-------------------------

### Approvals / Certificates

#### General approvals



Approval	Standard	Certificate Name
CCA DEKRA Certification B.V.	EN 60947	NTR NL 7617
CSA DEKRA Certification B.V.	C22.2	2516073
KEMA/KEUR DEKRA Certification B.V.	EN 60947	71-100670
UL UL International Germany GmbH	UL 1059	E 45172

#### Declarations of conformity and manufacturer's declarations

Approval	Standard	Certificate Name
EU-Declaration of Confor- mity WAGO GmbH & Co. KG	-	-
UK-Declaration of Confor- mity WAGO GmbH & Co. KG	-	-

### Downloads

#### Environmental Product Compliance

##### Compliance Search

Environmental Product  
Compliance  
2020-5477/1102-953



## Documentation

### Additional Information

Technical Section	pdf 2240.62 KB	
-------------------	-------------------	--

### Bid Text

2020-5477/1102-953	19.02.2019	xml 4.17 KB	
2020-5477/1102-953	07.08.2018	docx 15.09 KB	

## CAD/CAE-Data

### CAD data

2D/3D Models 2020-5477/1102-953	
------------------------------------	--

### CAE data

ZUKEN Portal 2020-5477/1102-953	
------------------------------------	--

## 1 Compatible Products

### 1.1 System counterpart

#### 1.1.1 Female connector/socket



**Item No.: 2020-102**

1-conductor female connector; Push-in CAGE CLAMP®; 1.5 mm<sup>2</sup>; Pin spacing 3.5 mm; 2-pole; 1,50 mm<sup>2</sup>; gray

**Item No.: 2020-202**

2-conductor female connector; Push-in CAGE CLAMP®; 1.5 mm<sup>2</sup>; Pin spacing 3.5 mm; 2-pole; 1,50 mm<sup>2</sup>; gray

### 1.2 Required Accessories

#### 1.2.1 End plate

##### 1.2.1.1 End plate



**Item No.: 2020-5491**

End and intermediate plate; 1 mm thick; for 4-conductor terminal blocks; gray

### 1.3 Optional Accessories

#### 1.3.1 Coding

##### 1.3.1.1 Coding



**Item No.: 2020-100**

Carrier with 6 coding pins; for coding of female plugs; for carrier terminal blocks; orange

### 1.3.2 DIN-rail

#### 1.3.2.1 Mounting accessories



**Item No.: 210-196**

Aluminum carrier rail; 35 x 8.2 mm; 1.6 mm thick; 2 m long; unslotted; similar to EN 60715; silver-colored



**Item No.: 210-198**

Copper carrier rail; 35 x 15 mm; 2.3 mm thick; 2 m long; unslotted; according to EN 60715; copper-colored



**Item No.: 210-197**

Steel carrier rail; 35 x 15 mm; 1.5 mm thick; 2 m long; slotted; similar to EN 60715; silver-colored



**Item No.: 210-114**

Steel carrier rail; 35 x 15 mm; 1.5 mm thick; 2 m long; unslotted; similar to EN 60715; silver-colored



**Item No.: 210-118**

Steel carrier rail; 35 x 15 mm; 2.3 mm thick; 2 m long; unslotted; according to EN 60715; silver-colored



**Item No.: 210-115**

Steel carrier rail; 35 x 7.5 mm; 1 mm thick; 2 m long; slotted; according to EN 60715; "Hole width 18 mm; silver-colored



**Item No.: 210-112**

Steel carrier rail; 35 x 7.5 mm; 1 mm thick; 2 m long; slotted; according to EN 60715; "Hole width 25 mm; silver-colored



**Item No.: 210-113**

Steel carrier rail; 35 x 7.5 mm; 1 mm thick; 2 m long; unslotted; according to EN 60715; silver-colored

### 1.3.3 Ferrule

#### 1.3.3.1 Ferrule



**Item No.: 216-241**

Ferrule; Sleeve for 0.5 mm<sup>2</sup> / 20 AWG; insulated; electro-tin plated; electrolytic copper; gastight crimped; acc. to DIN 46228, Part 4/09.90; white



**Item No.: 216-242**

Ferrule; Sleeve for 0.75 mm<sup>2</sup> / 18 AWG; insulated; electro-tin plated; electrolytic copper; gastight crimped; acc. to DIN 46228, Part 4/09.90; gray



**Item No.: 216-243**

Ferrule; Sleeve for 1 mm<sup>2</sup> / AWG 18; insulated; electro-tin plated; electrolytic copper; gastight crimped; acc. to DIN 46228, Part 4/09.90; red

### 1.3.4 Installation

#### 1.3.4.1 Cover



**Item No.: 709-156**

Cover; Type 3; suitable for cover carrier, type 3; 1 m long; transparent

#### 1.3.4.2 Cover carrier



**Item No.: 709-169**

Cover carrier; Type 3; incl. fixing/retaining screws and knurled nut; suitable for 279 to 282 and 880 Series rail-mounted terminal blocks; suitable for 264 Series miniature rail-mounted terminal blocks; suitable for 270 Series sensor and actuator terminal blocks; gray

### 1.3.5 Jumper

#### 1.3.5.1 Jumper



[Item No.: 2000-406/020-000](#)  
Delta jumper; insulated; light gray



[Item No.: 2000-410/000-006](#)  
Jumper; 10-way; insulated; blue



[Item No.: 2000-410](#)  
Jumper; 10-way; insulated; light gray



[Item No.: 2000-410/000-005](#)  
Jumper; 10-way; insulated; red



[Item No.: 2000-402/000-006](#)  
Jumper; 2-way; insulated; blue



[Item No.: 2000-402](#)  
Jumper; 2-way; insulated; light gray



[Item No.: 2000-402/000-005](#)  
Jumper; 2-way; insulated; red



[Item No.: 2000-402/000-018](#)  
Jumper; 2-way; insulated; yellow-green



[Item No.: 2000-403/000-006](#)  
Jumper; 3-way; insulated; blue



[Item No.: 2000-403](#)  
Jumper; 3-way; insulated; light gray



[Item No.: 2000-403/000-005](#)  
Jumper; 3-way; insulated; red



[Item No.: 2000-404/000-006](#)  
Jumper; 4-way; insulated; blue



[Item No.: 2000-404](#)  
Jumper; 4-way; insulated; light gray



[Item No.: 2000-404/000-005](#)  
Jumper; 4-way; insulated; red



[Item No.: 2000-405/000-006](#)  
Jumper; 5-way; insulated; blue



[Item No.: 2000-405](#)  
Jumper; 5-way; insulated; light gray



[Item No.: 2000-405/000-005](#)  
Jumper; 5-way; insulated; red



[Item No.: 2000-406/000-006](#)  
Jumper; 6-way; insulated; blue



[Item No.: 2000-406](#)  
Jumper; 6-way; insulated; light gray



[Item No.: 2000-406/000-005](#)  
Jumper; 6-way; insulated; red



[Item No.: 2000-407/000-006](#)  
Jumper; 7-way; insulated; blue



[Item No.: 2000-407](#)  
Jumper; 7-way; insulated; light gray



[Item No.: 2000-407/000-005](#)  
Jumper; 7-way; insulated; red



[Item No.: 2000-408/000-006](#)  
Jumper; 8-way; insulated; blue



[Item No.: 2000-408](#)  
Jumper; 8-way; insulated; light gray



[Item No.: 2000-408/000-005](#)  
Jumper; 8-way; insulated; red



[Item No.: 2000-409/000-006](#)  
Jumper; 9-way; insulated; blue



[Item No.: 2000-409](#)  
Jumper; 9-way; insulated; light gray



[Item No.: 2000-409/000-005](#)  
Jumper; 9-way; insulated; red



[Item No.: 2000-440](#)  
Jumper; from 1 to 10; insulated; light gray



[Item No.: 2000-433/000-006](#)  
Jumper; from 1 to 3; insulated; blue



[Item No.: 2000-433](#)  
Jumper; from 1 to 3; insulated; light gray



[Item No.: 2000-433/000-005](#)  
Jumper; from 1 to 3; insulated; red



[Item No.: 2000-434](#)  
Jumper; from 1 to 4; insulated; light gray



[Item No.: 2000-435](#)  
Jumper; from 1 to 5; insulated; light gray



[Item No.: 2000-436](#)  
Jumper; from 1 to 6; insulated; light gray



[Item No.: 2000-437](#)  
Jumper; from 1 to 7; insulated; light gray



[Item No.: 2000-438](#)  
Jumper; from 1 to 8; insulated; light gray



[Item No.: 2000-439](#)  
Jumper; from 1 to 9; insulated; light gray



[Item No.: 2000-405/011-000](#)  
Star point jumper; 3-way; insulated; light gray



[Item No.: 210-103](#)  
Wire commoning chain; insulated; black



[Item No.: 210-123](#)  
Wire commoning chain; insulated; blue

### 1.3.6 Marking

#### 1.3.6.1 Group marker carrier



[Item No.: 2009-191](#)  
Group marker carrier; gray

1.3.6.2 Marker



**Item No.: 793-3501**  
WMB marking card; as card; plain; snap-on type; white

**Item No.: 2009-113/000-006**  
WMB-Inline; for Smart Printer; 2300 pieces on roll; plain; snap-on type; blue

**Item No.: 2009-113/000-007**  
WMB-Inline; for Smart Printer; 2300 pieces on roll; plain; snap-on type; gray

**Item No.: 2009-113/000-023**  
WMB-Inline; for Smart Printer; 2300 pieces on roll; plain; snap-on type; green



**Item No.: 2009-113/000-017**  
WMB-Inline; for Smart Printer; 2300 pieces on roll; plain; snap-on type; light green

**Item No.: 2009-113/000-012**  
WMB-Inline; for Smart Printer; 2300 pieces on roll; plain; snap-on type; orange

**Item No.: 2009-113/000-005**  
WMB-Inline; for Smart Printer; 2300 pieces on roll; plain; snap-on type; red

**Item No.: 2009-113/000-024**  
WMB-Inline; for Smart Printer; 2300 pieces on roll; plain; snap-on type; violet



**Item No.: 2009-113**  
WMB-Inline; for Smart Printer; 2300 pieces on roll; plain; snap-on type; white

**Item No.: 2009-113/000-002**  
WMB-Inline; for Smart Printer; 2300 pieces on roll; plain; snap-on type; yellow

1.3.6.3 Marker carrier



**Item No.: 2000-121**  
Adaptor; gray

1.3.6.4 Marking strip



**Item No.: 2009-110**  
Marking strips; for Smart Printer; on reel; not stretchable; plain; snap-on type; white

1.3.7 Protective warning marker

1.3.7.1 Cover



**Item No.: 2000-115**  
Protective warning marker; for 5 terminal blocks; with high-voltage symbol, black; yellow

1.3.8 Push-in type wire jumper

1.3.8.1 Jumper



**Item No.: 2009-404**  
Push-in type wire jumper; 0.75 mm<sup>2</sup>; insulated; 110 mm long; gray

**Item No.: 2009-406**  
Push-in type wire jumper; 0.75 mm<sup>2</sup>; insulated; 250 mm long; gray

**Item No.: 2009-402**  
Push-in type wire jumper; 0.75 mm<sup>2</sup>; insulated; 60 mm long; gray

### 1.3.9 Screwless end stop

#### 1.3.9.1 Mounting accessories



**Item No.: 249-117**

Screwless end stop; 10 mm wide; for DIN-rail 35 x 15 and 35 x 7.5; gray



**Item No.: 249-116**

Screwless end stop; 6 mm wide; for DIN-rail 35 x 15 and 35 x 7.5; gray

### 1.3.10 Test and measurement

#### 1.3.10.1 Testing accessories



**Item No.: 2009-174**

Test plug adapter; for 4 mm Ø test plugs; for testing TOPJOB®S rail-mounted terminal blocks; gray



**Item No.: 2009-182**

Testing tap; for max. 2.5 mm<sup>2</sup>; tool-free connection for individual test wires 0.08 - 2.5 mm; gray

### 1.3.11 Tool

#### 1.3.11.1 Operating tool



**Item No.: 210-719**

Operating tool; Blade: 2.5 x 0.4 mm; with a partially insulated shaft



**Item No.: 210-648**

Operating tool; Blade: 2.5 x 0.4 mm; with a partially insulated shaft; angled; short



**Item No.: 210-647**

Operating tool; Blade: 2.5 x 0.4 mm; with a partially insulated shaft; multicoloured

## Installation Notes

### Installation

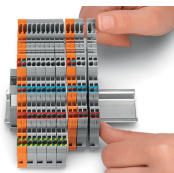

Snap individual terminal blocks onto the DIN-rail and slide together.



Separate terminal block assembly and slide individual terminal blocks laterally using an operating tool.

## Conductor termination



### All conductor types at a glance



## Testing



Testing via testing tap (2009-182) or test plug adapter (2009-174) (up to max. 42 V).

## Coding

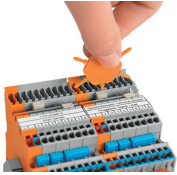

Insert coding pin into the corresponding slot and twist it off.

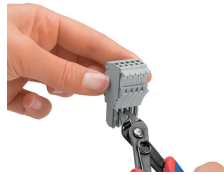

Remove the coding finger using a cutting tool.

## Locking system

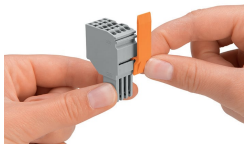

Slide the locking lever into position.

## Strain relief

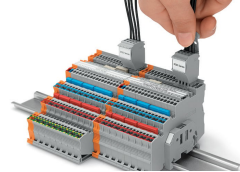
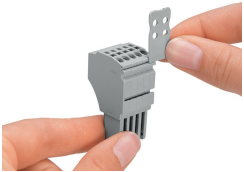

Removing a female plug via conductor bundle provided with strain relief plate.

## Marking

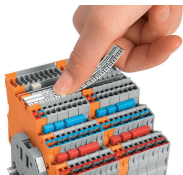

Labeling terminal blocks via marking strips (2009-110) or 3.5 mm wide WMB markers (793-35xx) – from the top or the side.