

ATAG One



NL

Korte installatiehandleiding

GB

Quick start guide

D

Schnellstartanleitung

F

Guide d'installation rapide

I

Guida rapida

Basisbediening ATAG One thermostaat

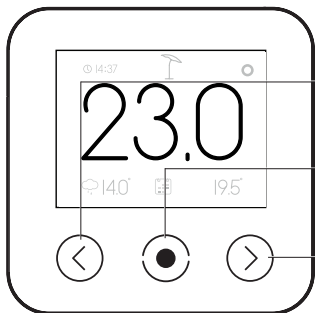

Pijl naar links:

- Verlagen van een waarde
- Naar boven scrollen

Centrale toets (blauw):

- Bevestigen van een vraag of keuze

Pijl naar rechts:

- Verhogen van een waarde
- Naar beneden scrollen

TIP: Als het beeldscherm donker of gedimd is kan deze geactiveerd worden door een van de toetsen aan te raken.

Basisweergave

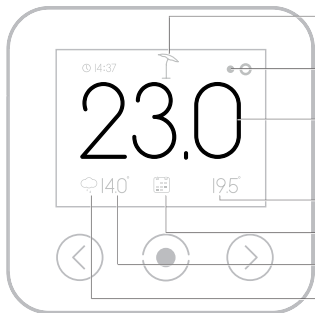

Zomer-eco modus (alleen bij weersafhankelijk regelen)

Indicatie ketel in bedrijf (continu > cv / knippert > tapwater)

Actuele ruimtetemperatuur

Ingestelde (of gevraagde) temperatuur

Gekozen functie (in dit geval volgens klokprogramma)

Buitentemperatuur (online of van buitenvoeler)

Weer-symbool (alleen indien online)



Bekijk de instructiefilmpjes
op het ATAG Verwarming
Youtube-kanaal

Welkom bij ATAG *One*, dé thermostaat.

Houd uw WiFi-netwerkbeveiligingssleutel (WiFi-code)
van uw thuisnetwerk bij de hand.

Geef deze code niet aan derden.

Zorg dat uw smartphone of tablet verbonden is met uw
WiFi-thuisnetwerk.

1. Download *One*-app op uw smartphone en/of tablet.
Ga naar de Playstore/Appstore en zoek op: atag one.

2. Verbinding maken met ATAG *One* thermostaat.
Bij eerste opstart:

Kies uw taal en volg de stappen tot WIFI CONFIGURATIE en kies: “APP”, “DIRECT” of “NIET NU”.

Bij reeds aangesloten *One*:

Ga naar INSTELLINGEN / CONFIGURATIE / WI-FI RECONFIGURATIE en kies: “APP”, “DIRECT” of “NIET NU”



“APP”	“DIRECT”	“NIET NU”
De One wordt met behulp van de app. aan WiFi verbonden > 2a	De One wordt direct aan WiFi verbonden > 2b	De One wordt niet aan WiFi verbonden en functioneert als kamerthermostaat > 2c



- 2a. Kiest u “APP” > Start *One*-app.

- Kies Wi-Fi configuratie.





Ga naar **INSTELLINGEN-WIFI** van uw smartphone/tablet.

- **Selecteer ATAG One XXXXXX** en wacht tot het vinkje wordt getoond.

- **Kies GA DOOR.**

Ga terug naar **One**-app.

- **Volg alle stappen op **One**-app en **One** thermostaat.**



De verbindingen zijn nu **VOLTOOID!**

- **Kies DOORGAAN.**

2b. Kiest u "**DIRECT**" dan volgen een aantal stappen.

- **Selecteer het juiste **NETWERK**.**

- **Vul het Wi-Fi **WACHTWOORD** in.**

Online setup is klaar.

- **Kies DOORGAAN.**



2c. Kiest u "**NIET NU**" dan volgen een aantal stappen voor

het instellen van de datum en tijd. De **One** wordt dan niet verbonden met het **Wi-Fi** netwerk en functioneert offline als kamerthermostaat.



Om gebruik te kunnen maken van alle diensten moet nu een account aangemaakt worden.

3. Maak vanuit het inlogscherm op *One*-app een account aan:



- Kies Gebruiker registreren

Zorg dat uw smartphone of tablet verbonden is met hetzelfde WiFi-thuisnetwerk als uw *One*. Controleer dit bij **INSTELLINGEN-WIFI** van uw smartphone/tablet.

4. Volg alle stappen op *ATAG One*-app

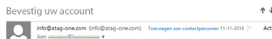

5. **Bevestig** de link in de email (controleer zo nodig de spambox).



Copyright © 2015 ATAG Verwarming Nederland B.V., All rights reserved.

6. Login op *One*-app met uw nieuwe accountgegevens

- Kies INLOGGEN
- Kies ZOEKEN
- Kies uw *One* **XXXXX**
- Kies VERBINDEN

Controle voor succesvolle verbinding:

De tijd op de ATAG *One* thermostaat moet gelijk zijn aan de tijd op uw smartphone/tablet.

Uw inloggegevens kunt u nu ook gebruiken om in te loggen op portal.atag-one.com



Bekijk de instructiefilmpjes op het ATAG Verwarming Youtube-kanaal:



atag-one.com



Basic Operation ATAG One thermostat

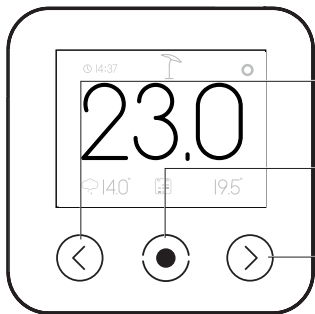

Left arrow key:

- Lowering the value
- Scrolling upwards

Centre key (blue):

- Confirming a question or selection

Right arrow key:

- Increasing a value
- Scrolling down

TIP: If the display is dark or dim, it can be activated by touching one of the keys.

Default readout screen

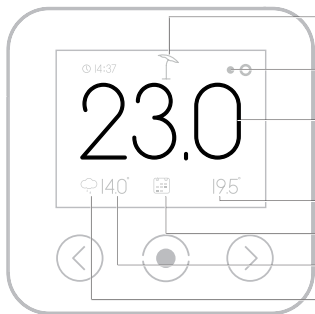

Summer eco mode (Only for weather dependent purposes)

Indication boiler in operation (continuously > cv / flashing > DHW)

Current room temperature

Set (or required) temperature

Selected function (in this case, according to schedule)

Outside temperature (online or from outdoor sensor)

Weather icon (only when online)



Watch the instructions video on Youtube.

Welcome to ATAG *One*, your thermostat.

Keep the Network security key or Wi-Fi code handy.
Do not give the code to third parties.

You must have your smart phone or tablet connected to your wireless network.

1. Download *One*-app on your smart phone and/or tablet. Go to the Playstore/Appstore and search for: atag one.
2. ATAG *One* thermostat.

At first start:

Select your language and follow the steps until CONFIGURE and choose: “APP”, “MANUAL” or “SKIP”.
(When *One* is already connected: Go to SETTINGS/CONFIGURATION/WI-FI RECONFIGURATION and select: “APP”, “MANUAL” or “SKIP”).

“APP”	“MANUAL”	“SKIP”
The <i>One</i> will be connected to WiFi by means of an app. > 2a	The <i>One</i> will be directly connected to WiFi > 2b	The <i>One</i> will not be connected to WiFi and functions as a room thermostat > 2c

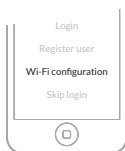

2a. When choosing “APP” > Start *One*-app.

- Press Wi-Fi configuration.



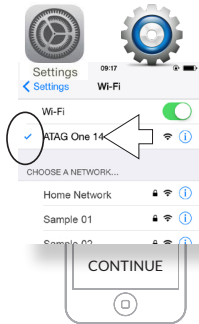

Go to SETTINGS/Wi-Fi of your smart phone or tablet.

- Select ATAG One xxxxxxxx and wait until the blue check mark is shown.
- Press CONTINUE.

Return to the One-app.

- Follow the steps on One-app and One thermostat.

The setup is now COMPLETED!

- Press CONTINUE.



2b. When choosing "MANUAL" follow a few steps.

- Select the right NETWORK.
- Enter the Wi-Fi PASSWORD.
- Press CONTINUE.

On-line setup is complete.



2c. When choosing "SKIP" follow the steps for adjusting time and date. The One will not be connected to the Wi-Fi network and will function offline as a room controller.

To use all features and services an account has to be created.

3. Create from the login screen from One app an account:

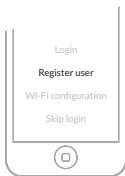

- Press REGISTER USER

Take care your smart phone or tablet is connected to the same wireless network as your One. Check this at SETTINGS/Wi-Fi of your smart phone or tablet.

4. Follow all steps on One-app.

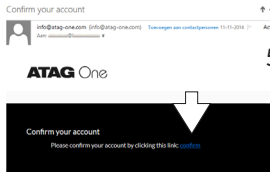

5. Open your e-mail (check your spam box, if necessary) and press the activation text.

6. Log in with your email address and the password you created previously

- Press LOGIN
- Press SEARCH
- Select your One XXXXX
- Press CONNECT



Check for a successful connection: Compare the displayed time of the One thermostat with the time on your smart phone or tablet. This must be equal.

You can now also use your account to login at:
portal.atag-one.com



Watch also the instruction films on Youtube:



atagheating.com

Bedienungsgrundlagen ATAG One Thermostat.

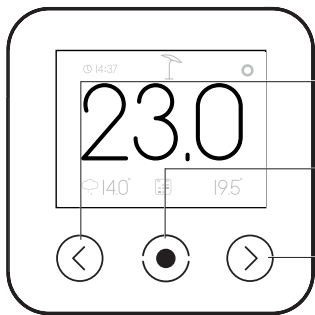

Pfeil nach links:

- Senken eines Wertes
- Nach oben scrollen

Zentrale Taste (blau):

- Bestätigung einer Frage oder Auswahl

Pfeil nach rechts:

- Erhöhen eines Wertes
- Nach unten scrollen

TIPP: Sollte das Display abgedunkelt oder ausgeblendet sein, kann dieses durch das Berühren einer Taste aktiviert werden.

Basisanzeige

Sommerabschaltung (nur wenn witterungsgeführt gesteuert)

Anzeige Kessel in Betrieb (ständig > cv / blinkt > warmwasser)

Aktuelle Zimmertemperatur

Eingestellte (oder erwünschte) Temperatur

Gewählte Funktion (in diesem Fall gemäß Uhrzeit-Programm)

Außentemperatur (online oder über Außensensor)

Wetter-Symbol (nur online)

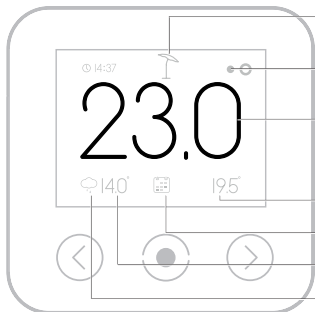



Sehen Sie sich die Instruktionfilme auf dem YouTube-Kanal von ATAG One an.

Willkommen bei ATAG One, Ihrem Thermostaten.

Legen Sie den WLAN-Netzwerkschlüssel (WLAN-Code) Ihres Heimnetzwerkes bereit.

Geben Sie diesen Code nicht an Dritte weiter.

Sorgen Sie dafür, dass Ihr Smartphone oder Tablet-PC mit Ihrem WLAN-Heimnetzwerk verbunden ist.

1. Laden Sie die ATAG One-App auf Ihr Smartphone und/oder Ihren Tablet-PC. Besuchen Sie den Google Playstore/Apple Appstore und geben Sie den Suchbegriff atag one ein.

2. ATAG One Thermostat:

Erstnutzung:

Wählen Sie die gewünschte Sprache und folgen Sie den Schritten bis zum Menüpunkt VERBINDEN und wählen Sie: "APP", "MANUAL" oder "SPÄTER".

(Im Falle eines bereits angeschlossenen ATAG One: Gehen Sie zu EINSTELLUNGEN/KONFIGURATION/WLAN-KONFIGURATION und wählen Sie: "APP", "MANUAL" oder "SPÄTER").

"APP"	"MANUAL"	"SPÄTER"
Die One wird mit Hilfe der App. mit WLAN verbunden > 2a	Die One wird direkt mit WLAN verbunden > 2b	Die One wird nicht mit WLAN verbunden und fungiert als Raumthermostat > 2c

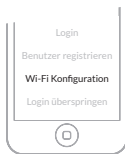

- 2a. Wenn Sie "APP" wählen > Starten Sie die ATAG One-App.

- Wählen Sie Wi-Fi Konfiguration.

D

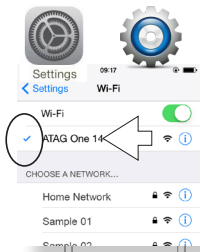

Gehen Sie im Menü Ihres Smartphones/Tablet-PCs zum Menüpunkt **WLAN-EINSTELLUNGEN-WIFI**.

- Wählen Sie **ATAG One XXXXX** und warten Sie, bis das Häkchen erscheint.

- Wählen Sie **WEITER**

Kehren Sie zur **ATAG One**-App zurück.

- Folgen Sie sämtlichen Schritten der **ATAG One**-App und des **ATAG One**-Thermostaten.



Die Verbindung ist nun hergestellt und nutzbar.

- Wählen Sie **WEITER**



2b. Sollten Sie sich für **MANUAL** entscheiden, folgen einige Schritte.

- Wählen Sie das richtige Netzwerk.
- Geben Sie das **WLAN**-Passwort ein. Online Setup is abgeschlossen.
- Wählen Sie **WEITER**.



2c. Sollten Sie sich für **SPÄTER** entscheiden, folgen einige Schritte zum Einstellen von Datum und Uhrzeit. Der **ATAG One** wird dann nicht mit dem **WLAN**-Netzwerk verbunden und fungiert offline als Raumthermostat.



Um alle Dienste nutzen zu können, muss jetzt ein Konto angelegt werden.

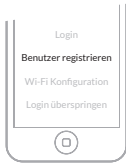

- Erstellen Sie vom Anmeldeschirm der ATAG One-App aus Ihr Nutzerkonto. Wählen Sie Benutzer registrieren.

Sorgen Sie dafür, dass Ihr Smartphone oder Tablet-PC mit demselben WLAN-Heimnetzwerk verbunden ist wie Ihr ATAG One. Überprüfen Sie die WLAN-EINSTELLUNGEN Ihres Smartphones/Tablet-PCs.

- Befolgen Sie die von der ATAG One-App angezeigten Schritte.

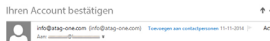

ATAG One

- Bestätigen Sie den Link in der E-Mail (überprüfen Sie, sofern nötig, Ihren Spam-Ordner).



- Melden Sie sich mit Ihren Daten aus Ihrem Nutzerkonto bei der ATAG One-App an.

Wählen Sie Login.

Wählen Sie die Schaltfläche SUCHEN.

Wählen Sie Ihren One XXXXX aus.

Wählen Sie die Schaltfläche VERBINDEN.

D



TIPP: Ist die Verbindung erfolgreich hergestellt worden, muss die Uhrzeit auf dem ATAG One Thermostaten mit der Uhrzeit auf Ihrem Smartphone/Tablet-PC übereinstimmen.

Sie können Ihre Anmeldedaten jetzt auch zur Anmeldung auf der Website portal.atag-one.com nutzen.



Weitere Hinweise zur Bedienung und den Funktionen Ihres ATAG One erhalten Sie auf YouTube unter ATAG One.



atagheating.com

Commande de base thermostat ATAG One

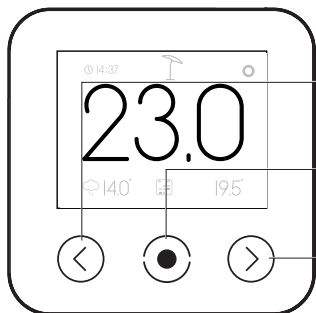

Flèche gauche :

- Diminuer une valeur
- Défiler vers le haut

Touche centrale (bleue) :

- Confirmation d'une question ou un choix

Flèche droite :

- Augmenter une valeur
- Défiler vers le bas

CONSEIL : Si l'écran est foncé ou en veilleuse, il peut être activé en activant une des touches.

Affichage de base

Mode été-éco (uniquement avec régulation climatique)

Indication chaudière en fonctionnement (continu > cv / clignote > eau du robinet)

Température ambiante actuelle

Température réglée (ou demandée)

Fonction choisie (dans ce cas-ci suivant programme horloge)

Température extérieure (en ligne ou sonde extérieure)

Symbole météo (uniquement en ligne)

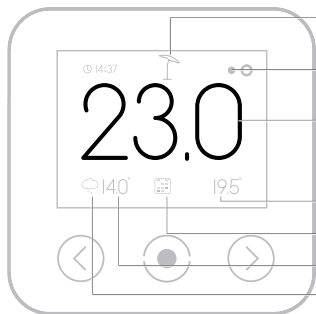



Regardez les petits films d'instructions sur de canal Youtube ATAG One

Bienvenue chez ATAG One, LE thermostat.

Gardez votre clé de sécurité réseau (code WiFi) de votre réseau domestique près de la main.

Ne communiquez jamais ce code à des tierces personnes. Veillez à ce que votre smartphone ou tablette soit connecté à votre réseau WiFi domestique.

1. Téléchargez l'app One sur votre smartphone et/ou tablette.

Allez sur Playstore/Appstore et cherchez : atag one.

2. Thermostat ATAG One.

Au premier démarrage :

Sélectionnez votre langue et suivez les étapes jusqu'à CONFIGURER et choisissez : "APP", "MANUEL" ou "SAUTER".

(Si One est déjà raccordé : allez à REGLAGES/ CONFIGURATION/RECONFIGURATION WI-FI et choisissez CONFIGURER : "APP", "MANUEL" ou "SAUTER").



"APP"	"MANUEL"	"SAUTER"
Le One se raccorde au WiFi à l'aide de l'app. > 2a	Le One est raccordé directement au WiFi > 2b	Le One ne se raccorde pas au WiFi et fait fonction de thermostat d'ambiance > 2c

- 2a. Vous choisiss > Démarrage One-app.

- Choisissez Configuration Wi-Fi.

F

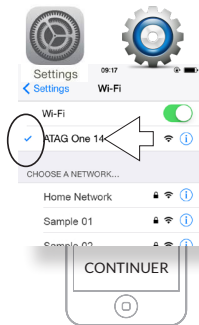

Allez à REGLAGES-WIFI de votre smartphone/tablette.
Sélectionnez ATAG One XXXXX et attendez l'apparition de la coche.

- Choisissez CONTINUER.

Retournez vers One-app.

- Suivez toutes les étapes sur One-app et One thermostat.

Les connexions sont maintenant TERMINEES !

- Choisissez CONTINUER.

2b. Sélectionnez "MANUEL" des étapes pour le réglage.

- **Sélectionnez** le bon RÉSEAU.
- **Entrer** MOT DE PASSE Wi-Fi.
Installation en ligne terminée.
- Choisissez CONTINUER.

2c. Si vous sélectionnez "SAUTER" des étapes pour le réglage de la date et de l'heure suivront. Le One ne sera pas connecté au réseau Wi-Fi et fonctionnera alors hors ligne en tant que thermostat d'ambiance.



Pour pouvoir profiter de tous les services, il faut maintenant créer un compte.

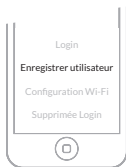

3. Créez un compte à partir de la fenêtre de connexion sur *One-app* en : Sélectionnez Enregistrer utilisateur

Veillez à ce que votre smartphone ou tablette soit connecté au même réseau WiFi domestique que votre *One*. Vérifiez ceci dans les REGLAGES –WiFi de votre smartphone/tablette.

4. Suivez toutes les étapes sur *ATAG One-app*



5. Confirmez le lien dans l'e-mail (si besoin, contrôlez le spam box).

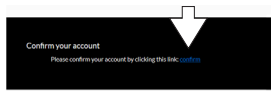

6. Connectez-vous sur *One-app* avec vos nouvelles données de compte
 - Sélectionnez CONNECTER
 - Sélectionnez CHERCHER
 - Sélectionnez votre *One XXXXX*
 - Sélectionnez CONNECTER



Contrôle pour une connexion réussie :
L'heure sur le thermostat ATAG *One* doit être la même
que celle sur votre smartphone/tablette.

Vous pouvez maintenant aussi utiliser vos données
d'accès pour vous connecter sur portal.atag-one.com



Regardez également les petits films d'instructions sur de
canal Youtube ATAG Chauffage:



atagheating.com

Utilizzo di base del termostato ATAG One

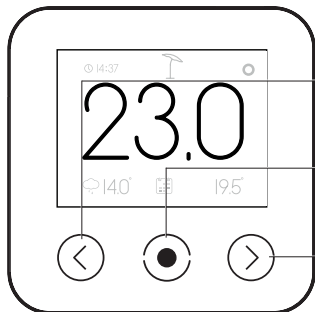

Freccia a sinistra:

- Abbassamento di un valore
- Scorri in alto

Tasto centrale (blu):

- Conferma a una domanda o scelta

Freccia a destra:

- Aumento di un valore
- Scorri in basso

SUGGERIMENTO: Se lo schermo diviene scuro o meno luminoso può essere attivato toccando uno dei tasti.

Indicazioni di base

Commutazione Estiva (Solo a regolazione climatica)

Indicazione di caldaia in funzione (continuo > cv / lampeggia > acqua calda)

Temperatura ambientale attuale

Temperatura impostata (o richiesta)

Funzione selezionata (in questo caso secondo il programma di ora)

Temperatura esterna (online o del sensore esterno)

Simbolo del tempo atmosferico (solo online)

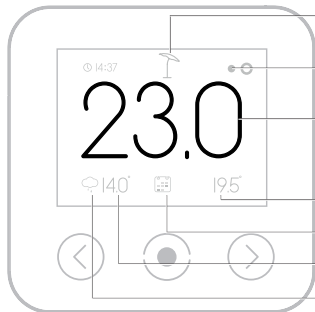



Visualizza i tutorial sul canale YouTube ATAG One

Benvenuto in ATAG One.

Tieni a portata di mano la tua chiave di sicurezza della rete WiFi (codice WiFi) della tua rete domestica.

Non rendere noto questo codice a terzi.

Assicurati che il tuo smartphone o tablet sia collegato alla tua rete WiFi domestica.

1. Scarica l'applicazione One-app sul tuo smartphone e/o tablet. In Playstore/Appstore cerca atag one.
2. Termostato ATAG One.

Al primo avvio:

Seleziona la tua lingua e segui i passaggi fino a CONNETTERE e seleziona: "APP", "MANUALE" o "SALTARE".

(In caso di One già collegato: Vai su IMPOSTAZIONI/PROGRAMMAZIONE/RECONFIGURAZIONE WIFI e seleziona CONNETTERE: "APP", "MANUALE" o "SALTARE").

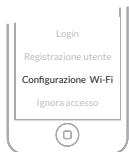

"APP"	"MANUALE"	"SALTARE"
ATAG One sarà collegato a WIFI utilizzando l'applicazione One-app > 2a	ATAG One sarà collegato direttamente a WIFI > 2b	ATAG One non sarà collegato a WIFI e funziona come termostato ambiente > 2c

2a. Avvia la One-app.

- **Seleziona la Configurazione Wi-Fi.**



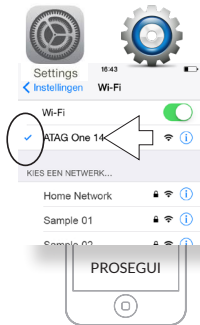

Vai su **IMPOSTAZIONI-WIFI** del tuo smartphone/tablet. Seleziona **ATAG One XXXXX** e attendi che compaia il segno di spunta.

- Seleziona **PROSEGUI**.

Ritorna a **One-app**.

- Segui i passaggi sulla **One-app** e sul termostato **One**.



I collegamenti ora sono **PRONTI!**

- Seleziona **PROSEGUI**.



2b. Seleziona **MANUALE** e segui i vari passaggi.

- Seleziona la **RETE** corretta.
- Inserire la **PASSWORD** Wi-Fi. Il setup on-line è completato.
- Seleziona **PROSEGUI**.



2c. Seleziona **SALTARE** e segui i vari passaggi per l'impostazione di data e orario. Il termostato **One** non viene così collegato alla rete **Wi-Fi** e funziona offline come termostato ambientale.

Per potere utilizzare tutti i servizi è necessario creare un account.

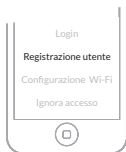

3. Dalla schermata di login della One-app crea un account: Seleziona Registrazione utente

Assicurati che il tuo smartphone o tablet sia collegato alla stessa rete WiFi domestica del tuo One. Verifica questo nelle IMPOSTAZIONI-WIFI del tuo smartphone/tablet.

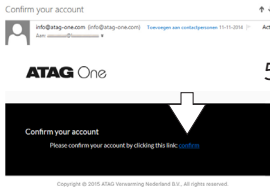

4. Segui tutti i passaggi nella *One*-app

5. Conferma il link nella e-mail (se necessario controlla la casella spam).

6. Accedi alla *One*-app con i dati del tuo account
- Seleziona ESEGUI IL LOGIN
 - Seleziona CERCA
 - Seleziona il tuo One XXXXX
 - Seleziona COLLEGA



Verifica di collegamento eseguito con successo:
L'orario riportato sul termostato ATAG One deve essere uguale a quello del tuo smartphone/tablet.

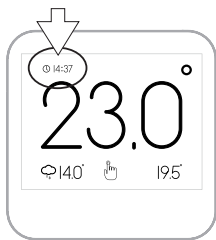

Puoi ora utilizzare i tuoi dati di accesso anche per accedere a portal.atag-one.com



Visualizza anche i tutorial sul canale YouTube ATAG One:



atagheating.com

Wijzigingen voorbehouden.
Changes reserved. E.& O. E.
Änderungen und Irrtümer vorbehalten.
Modifications réservée.
Modifiche riservate.