

13 420 979 Product version from 4/1/2023





- CASCADE, max. flow rate 26.5 l/min (at 3 bar)
- Function from: 22.5 l/min
- with anti-scale system

Technical data:

- cover plate 240 x 60 mm
- 120mm projection
- 1/2" connection
- plug-link mounting

Notes:

	Matte Black	13 420 979-33
	Chrome	13 420 979-00
	Brushed Platinum	13 420 979-06
	Platinum	13 420 979-08
	Dark Chrome	13 420 979-19
	Light Gold (PVD)	13 420 979-26
	Brushed Light Gold (PVD)	13 420 979-27
	Brushed Durabronze (23kt Gold)	13 420 979-28
	Brushed Gold (PVD)	13 420 979-37
	Brushed Dark Brass (PVD)	13 420 979-39
	Brushed Bronze (PVD)	13 420 979-42
	Brushed Dark Bronze (PVD)	13 420 979-43
	Brushed Champagne (22kt Gold)	13 420 979-46
	Champagne (22kt Gold)	13 420 979-47
	Brushed Chrome	13 420 979-93

Recommended miscellaneous



Concealed wall elbow -

- min. recess depth 90 mm
- max. recess depth 163 mm

35 085 970 90

Recommended miscellaneous



Concealed wall elbow -

- min. recess depth 90 mm
- max. recess depth 163 mm

35 085 970 90

13 420 979 Product version from 4/1/2023

mm [inches]

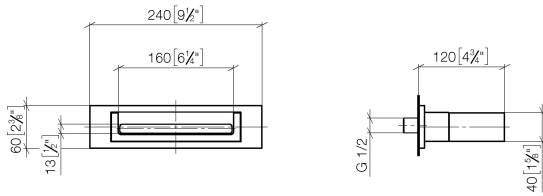

Flow rate chart

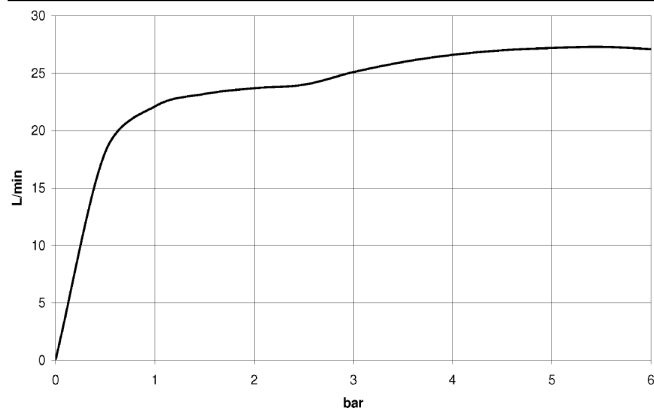

Trajectory diagram

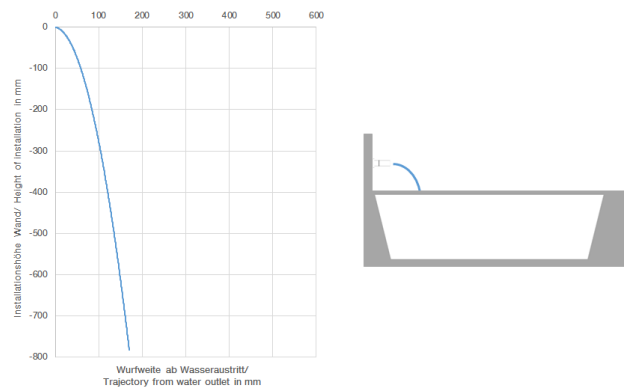

Codes & Standards

ASME A112.18.1

cUPC

DIN 4109

ISO 3822

Scottish Water
Byelaws

UK Water Supply
Regulations

Ü-Zeichen



WATER FALL Cascade spout for wall mounting - Matte Black

SERIES-VARIOUS

13 420 979 Product version from 4/1/2023

Certificates and sustainability

LGA_18

IAPMO_4976

WRAS_2111

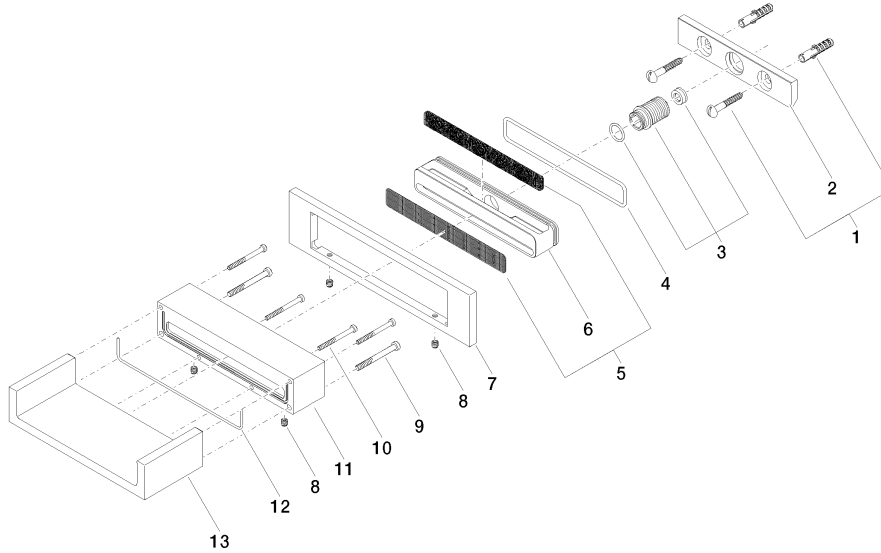

Spare parts list

No.	Item Number	Name	Quantity used	Delivery time
9	09 30 30 147 90	Mounting Cylinder head screw with hexagon socket Low profile M5 x 50 mm -	2.00	14
5	90 29 30 040 00 90	Insert Filter 158,6 x 20,70 x 0,8 mm -	1.00	14
6	09 17 11 044 20 90	Mounting for Water Fall Distributor 163 x 26 x 30,5 mm -	1.00	14
10	09 30 30 086 90	Mounting Cylinder head screw with hexagon socket Low profile M4 x 45 mm -	4.00	14
1	04 30 31 024 01 90	Attachment set Wood screw with dowel 6 x 40 mm -	1.00	14
13	09 11 94 046-33	Spout 181 x 41 x 78 mm - Matte Black	1.00	40
2	09 17 97 056 90	Holder 145 x 30 x 8 mm -	1.00	14
11	09 30 01 104-33	Body 181 x 41 x 42 mm - Matte Black	1.00	40
3	90 24 05 008 00 90	Nipple Ø 23 x 35 mm -	1.00	14
4	09 14 10 504 90	O-Ring NBR 70 106 x 3 mm -	1.00	14
7	09 27 97 034-33	Rosette 240 x 60 x 9 mm - Matte Black	1.00	40
12	09 14 03 504 90	Washer Ø 2 x 205 mm -	1.00	14
8	09 31 11 049 90	Mounting Threaded pin with hexagon socket with cup point M6 x 6 mm -	4.00	14