

Veerring volgens DIN 128 vorm A.

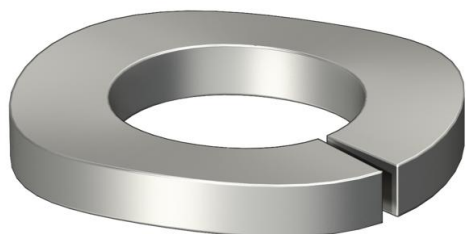

A2	A4	A5	Roestvast staal	Roestvast staal	Roestvast staal
2B	Blank, nabehandeld				

Stamgegevens

Artikelnummer	3405089
Type	LWS M8 A4
Omschrijving 1	Veerring
Fabrikant	OBO
Dimensie	M8
Materiaal	Roestvast staal
Oppervlak	blank, nabehandeld
Oppervlaktenorm	
Kleinste verkoop-eenheid	100
Eenheid van hoeveelheid	Stuk
Gewicht	0,13 kg
Eenheid gewicht	kg/100 st.

Afmetingen

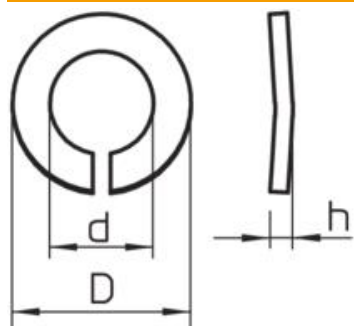

Hoogte	2,6 mm
Maat d	8,3 mm
Afmeting d max.	14,8 mm
Afmeting d min.	14,8 mm
Afm. h	2,6 mm

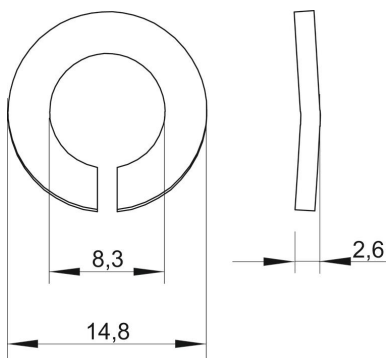
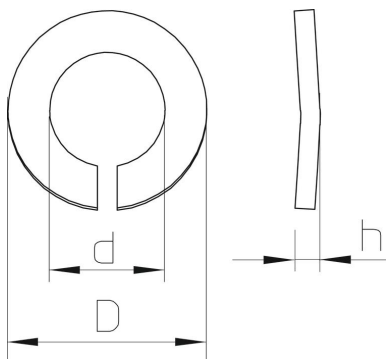

Technische gegevens

Schroefdraad	M8
Binnendiameter	8,3 mm
Uitvoering borgring	gegolfd