

Veerring M8

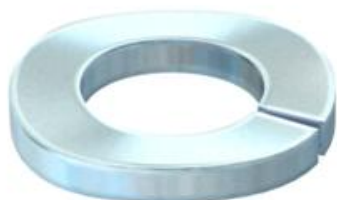

St Staal

G galvanisch verzinkt

Stamgegevens

Artikelnummer	3405087
Type	LWS M8 G
Omschrijving 1	Veerring
Fabrikant	OBO
Dimensie	M8
Materiaal	Staal
Oppervlak	galvanisch verzinkt
Oppervlakenorm	EN ISO 19598 / EN ISO 4042
Kleinste verkoop-eenheid	100
Eenheid van hoeveelheid	Stuk
Gewicht	0,13 kg
Eenheid gewicht	kg/100 st.

Afmetingen

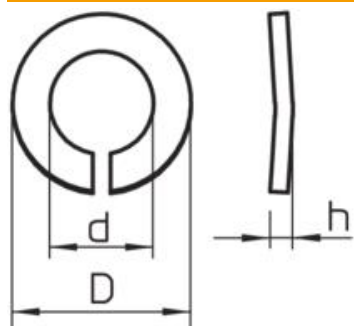

Hoogte	2,6 mm
Plaatdikte	0,1 in
Maat D	0,58 in
Maat d	0,33 in
Maat d	8,3 mm
Afmeting d max.	14,8 mm
Afmeting d min.	14,8 mm
Afm. h	2,6 mm

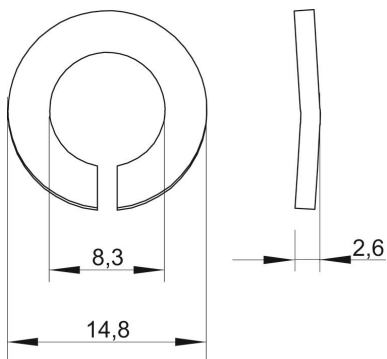
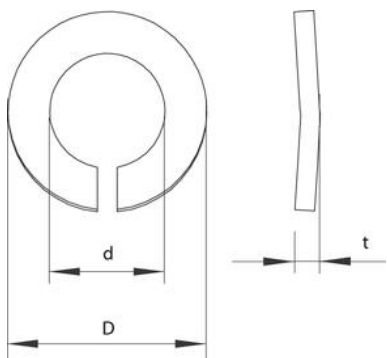
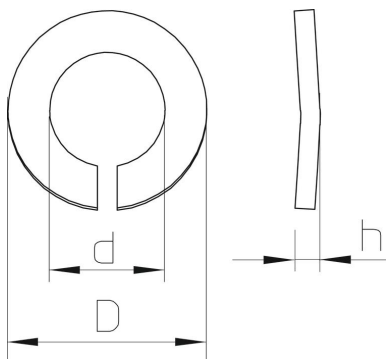

Technisch specificatieblad

Veerring

Artikelnummer: 3405087



Technische gegevens

Schroefdraad	M8
Binnendiameter	0,33 mm
Uitvoering borgring	gegolfd