

Veerring M6

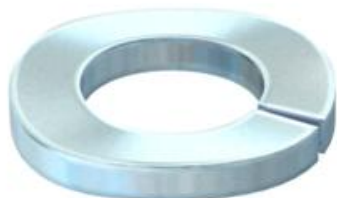

St Staal

G galvanisch verzinkt

Stamgegevens

Artikelnummer	3405060
Type	LWS M6 G
Omschrijving 1	Veerring
Fabrikant	OBO
Dimensie	M6
Materiaal	Staal
Oppervlak	galvanisch verzinkt
Oppervlakenorm	EN ISO 19598 / EN ISO 4042
Kleinste verkoop-eenheid	100
Eenheid van hoeveelheid	Stuk
Gewicht	0,07 kg
Eenheid gewicht	kg/100 st.

Afmetingen

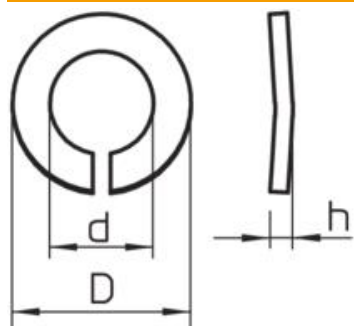

Hoogte	2,1 mm
Plaatdikte	0,08 in
Maat D	0,46 in
Maat d	0,25 in
Maat d	6,3 mm
Afmeting d max.	11,8 mm
Afmeting d min.	11,8 mm
Afm. h	2,1 mm

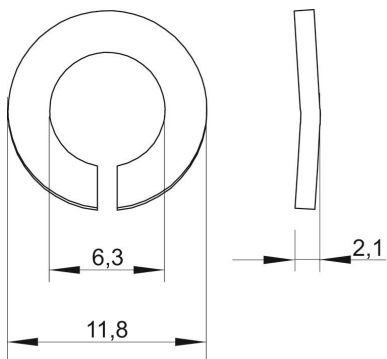
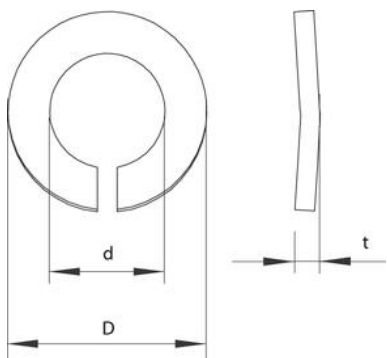
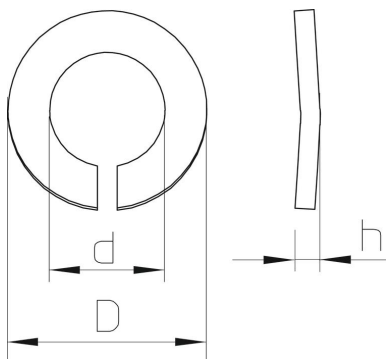

Technisch specificatieblad

Veerring

Artikelnummer: 3405060



Technische gegevens

Schroefdraad	M6
Binnendiameter	0,25 mm
Uitvoering borgring	gegolfd