

Technical data sheet

Clamp clip 2056, F-foot, single, plastic pressure trough,
ALU

Item number: 1188240



Clamp clip with F-foot, plastic pressure trough made of polypropylene. For vertical and horizontal mounting of 1 single cable on flat bars. With 1-start screw thread on pressure trough, universal hexagonal screw head WAF10, with slot and cross recess. Suitable for mounting indoors and outdoors. We recommend the use of a counter-trough.



Alu Aluminium

Master data

Item number	1188240
Type	BS-F1-K-28 ALU
Description 1	Clamp clip 2056
Manufacturer	OBO
Dimension	22-28mm
Material	Aluminium
Smallest sales unit	100
Unit of quantity	Piece
Weight	2.052 kg
Weight unit	kg/100 pc.
CO2 Footprint (GWP) Cradle-to-Gate	0,2861 kg CO2e / 1 Piece

Technical data sheet

Clamp clip 2056, F-foot, single, plastic pressure trough,
ALU

Item number: 1188240



Dimensions

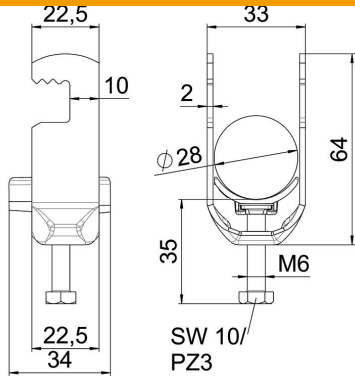

Length	22.5 mm
Width	33 mm
Height	64 mm
Plate thickness	2 mm
Dimension A	22.5 mm
Dimension B	33 mm
Dimension C	34 mm
Dimension G (mm)	M6
Dimension H	64 mm
Dimension L	35 mm
Dimension t	2 mm

Technical data

Number of cables/pipes	1
For pipe diameter, max.	28 mm
For pipe diameter, min.	22 mm
Thread	M6
Halogen-free	yes
Length of external dimensions	34 mm
Max. Tightening torque	3 Nm
With plastic trough	yes
Mounting type	Flat profile
Slot width	10 mm
Clamping range D, max.	28 mm
Clamping range D, min.	22 mm
Surface addition	Untreated
Material addition	Aluminium