

UP-Einhandbatterie mit Abdeckplatte - Chrom gebürstet

TARA













36 060 660



- Abdeckplatte Ø 78 mm
Passt zu META, TARA

Passt zu META, TARA

Passt zu: TARA, META

	Chrom gebürstet	36 060 660-93
	Chrom	36 060 660-00
	Platin gebürstet	36 060 660-06
	Platin	36 060 660-08
	Dark Chrome	36 060 660-19
	Light Gold	36 060 660-26
	Light Gold gebürstet	36 060 660-27
	Messing gebürstet (23kt Gold)	36 060 660-28
	Schwarz matt	36 060 660-33
	Bronze gebürstet	36 060 660-42
	Champagne gebürstet (22kt Gold)	36 060 660-46
	Champagne (22kt Gold)	36 060 660-47
	Dark Platinum gebürstet	36 060 660-99

Benötigtes Zubehör



- UP-Wand-Einhandbatterie -** 35 860 970 90
- Max. Einbautiefe 95 mm
 - Min. Einbautiefe 75 mm

36 060 660

mm [inches]

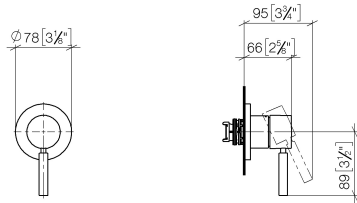

Codes & Standards

DIN 4109

ISO 3822

Scottish Water
Byelaws

UK Water Supply
Regulations

Ü-Zeichen

Zertifikate

WRAS_2107

LGA_29

36 060 660

Produktversion bis 6/29/2020

Produktversion ab 6/29/2020

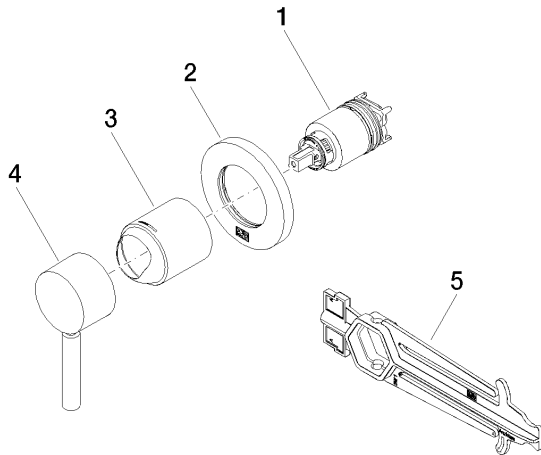



UP-Einhandbatterie mit Abdeckplatte - Chrom gebürstet

TARA

36 060 660

Ersatzteilstückliste

Produktversion bis 6/29/2020

Produktversion ab 6/29/2020

Nr.	Artikelnummer	Benennung	Verbaumenge	Lieferzeit
	90 15 05 064 01 90	Kartusche mit Adapterplatte Ø 35 mm x 58,6 mm -	5	2