

# 5.6

## Exit signs - Indoor

Style 28011 / 28021

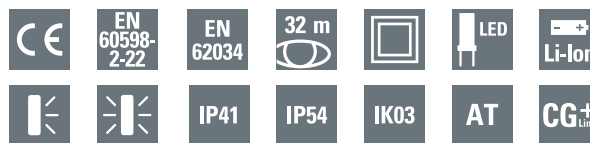

- For stand-alone operation or for connection to the self-contained luminaire monitoring system CGLine+
- Universal use for maintained and non-maintained operation and for 1 h, 3 h or 8 h operation
- Dimmable in three steps for use in dark ambient conditions
- IP54 Kit available (for 28011)

### Light Source:

28011: 3 x 1 W LEDs

28021: 4 x 1 W LEDs

### Materials:

Polycarbonate housing

Colour : Light grey, sim. RAL7035

Lithium ion battery

### Installation:

28011: Wall mounting

28021: Ceiling mounting

Terminals : Through-wiring from mains (L, L', N, PE) up to 2.5 mm<sup>2</sup>

CGLine+ bus through-wiring up to 1.5 mm<sup>2</sup>

### Operation:

For maintained and non-maintained operations

CGLine+ (Without bus working in AT mode)

For 1 h, 3 h or 8 h operation

Style Variant 28011 & 28021 LED is a range of exit sign luminaires with a viewing distance of 32m. Available as single and double-sided versions with a pictogram foil set, this range is suitable for a wide spectrum of applications.

Optimal perceptibility of the luminaire is achieved by the high luminance of the white contrasting colour (>500 cd/m<sup>2</sup>). One, three or eight hours rated operating duration can be freely specified according to application.

The use of LEDs, automatic testing and monitoring devices (CGLine+) significantly reduce the operating and maintenance costs of the installation.

28011 LED CGLine+

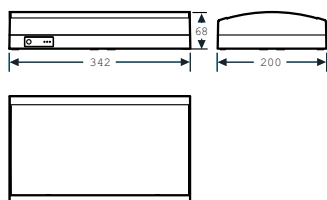



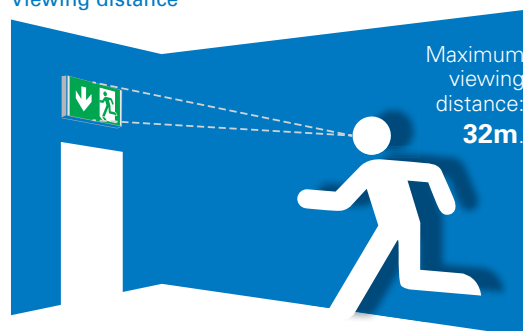





Viewing distance



Viewing distance of 32 meters provides the ability to use fewer products and less power consumption per coverage area of an application.

### Applications:

Hotels, cinemas, theaters, schools and hospitals

Order code	Description				
40071354817	Single-sided Exit sign luminaire 28011 1-8h/D LED CGLine+ (Set), including transparent cover and 3 pictogram foils LEFT, RIGHT, DOWN 	7 VA/6.6 W	1h, 3h, 8h	LiNiMnCoO <sub>2</sub> 3.7V/4Ah	Maintained / Non-Maintained
40071354815	Single-sided Exit sign luminaire 28011 1-8h/D LED CGLine+ without cover	7 VA/6.6 W	1h, 3h, 8h	LiNiMnCoO <sub>2</sub> 3.7V/4Ah	Maintained / Non-Maintained
40071354818	Double-sided Exit sign luminaire 28021 1-8h/D LED CGLine+ (Set), including transparent cover and 3 pictogram foils LEFT, RIGHT, DOWN 	8.8 VA/8.3 W	1h, 3h, 8h	LiNiMnCoO <sub>2</sub> 3.7V/4Ah	Maintained / Non-Maintained
40071354816	Double-sided Exit sign luminaire 28021 1-8h/D LED CGLine+	8.8 VA/8.3 W	1h, 3h, 8h	LiNiMnCoO <sub>2</sub> 3.7V/4Ah	Maintained / Non-Maintained
40071354130	Cover Pictogram Arrow LEFT, ISO with silkscreen pictogram				
40071354131	Cover Pictogram Arrow RIGHT, ISO with silkscreen pictogram				
40071354132	Cover Pictogram Arrow DOWN, ISO with silkscreen pictogram				
40071354597	Blind Cover				

28021 LED CGLine+

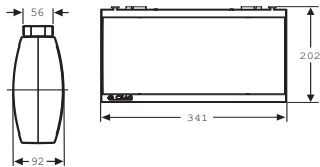

Chain fastening



Ceiling mounting



28021 LED CGLine+  
with ceiling mounting

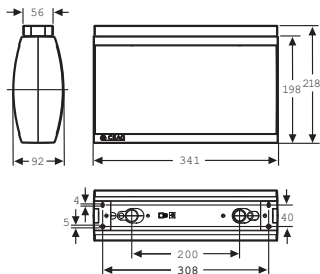

Wall bracket

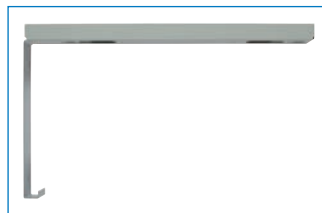

28021 LED CGLine+  
with wall bracket

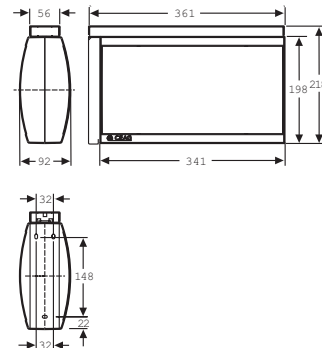

### Accessories

Order code	Description
<b>28011 LED CGLine+</b>	
40071348370	Wire guard
40071354748	IP54 <sup>1)</sup> set for 28011 LED CGLine+
<b>28021 LED CGLine+</b>	
40071350432	Ceiling mounting for ceiling mounting and chain fastening with chain link diameter < 5 mm
40071350400	Suspension set 0.5 m with canopy
40071351158	Chain fastening <sup>2)</sup> ring-eyelet
40071350418	Wall bracket

<sup>1)</sup>IP54 for electronic and lamp. For increased tightness requirements indoor or in canopied outdoor areas

<sup>2)</sup> For chain link diameter from 5 to 12 mm ceiling mounting 40071350432 required