

Features

- Compact, energy efficient and exceptional value LED GU10 lamp Same shape and size as halogen GU10 lamp Compact Cluster SMD technology enabling high efficiency with halogen look Reduced visible heat sink from the front Available in 110 degree beam angle High lumen efficacy 15,000 hours average rated life 3 years warranty

Product Overview

Product name	RefLED ES50 V6 320LM 840 110 SL
Technology	LED
Watt (Rated) (W)	4.2
Cap/Base	GU10
Fixture rating	Open
E-number FI	4741062
Colour temperature (K)	4000
CRI (Ra)	80
Colour Consistency (SDCM)	6
Colour Variation Initial (SDCM)	6
Photobiological Risk Group	RG1
Wattage (W)	4.2
Product EAN number	5410288291741
Warranty	3 years

Technical drawings

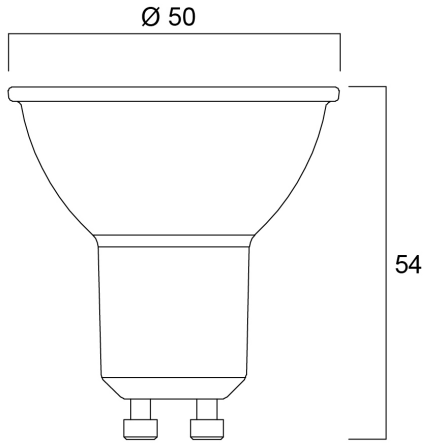

Data table

GENERAL DATA

Product name	RefLED ES50 V6 320LM 840 110 SL
Technology	LED
Watt (Rated) (W)	4.2
Cap/Base	GU10
Fixture rating	Open
Operating temperature range (°C)	-20°C...+40°C
Performance ambient temperature Tq (°C)	25
E-number FI	4741062
Warranty	3 years

OPTICAL DATA

Colour temperature (K)	4000
CRI (Ra)	80
Colour Consistency (SDCM)	6

RefLED ES50 V6 320LM 840 110 SL 0029174

Colour Variation Initial (SDCM)	6
Luminous Intensity (cd)	170
Photobiological Risk Group	RG1
Lumen maintenance at end of nominal life (%)	70

ELECTRICAL DATA

Wattage (W)	4.2
Equivalent watt (W)	45
Primary Supply/Product voltage - min (V)	220
Control gear required	No
Inrush Current (A)	3.9
Inrush Duration (μ s)	4100
Lamp Energy Label (class)	F
Nominal Frequency (Hz)	50/60Hz

LIFETIME DATA

Lifespan L70 B50	15000
Average life (Rated) (h)	15000

PHYSICAL DATA

Nominal Product Diameter (mm)	50
Weight (kg)	0.035

PACKAGING

Single packaging type	Carton
Product EAN number	5410288291741
Packaging single width (cm)	6.1
Packaging single depth (cm)	5.1
DUN14 (inner)	25410288291745
Units per inner package	6
Packaging inner length / height (cm)	9.2
Packaging inner width (cm)	16.4

RefLED ES50 V6 320LM 840 110 SL
0029174

Packaging inner depth (cm)	13.1
DUN14 (outer)	15410288291748
Packaging outer length / height (cm)	20.8

SAFETY DATA

Optimal operating condition (°C)	-20-40
Breakage cleaning instructions	Not applicable
Special purpose lamp	No
Dry applications use only	No
Suitable for household illumination	No
Safety message	Not Suitable for totally enclosed fixtures

SYLVANIA

RefLED ES50 V6 320LM 840 110 SL
0029174

Energy label



0029174



5
kWh/1000h



2019/2015



0029174



5
kWh/1000h



2019/2015