

Concord

MC2 TRIM 2.4M 3K DALI WHT OPAL 2071489

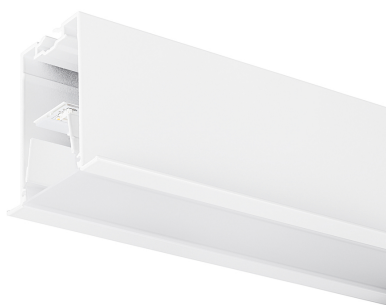

Features

- MC2 TRIM 2.4M 3K DALI WHT OPAL LED luminaire, white RAL9016 finishing, direct distribution, trim detail for plasterboard ceilings, suitable for recessed installation either horizontally or vertically, various accessories available, compact and minimalist design based on the Golden Mean, ideal for offices, meeting rooms, corridors, education facilities, museums and libraries, extruded aluminium body, diffuser: opal, colour temperature: 3000K warm white, total system power: 36W, total fixture output: 4600lm, luminaire efficacy: 128lm/W, LOR: 100%, colour rendering: Ra >80, LED Chromacity: 3 step MacAdam ellipse, lifespan: 66,000 hours L90B10, IR/UV free light source without heat radiation, operating voltage: 220-240V / 50-60Hz, drive current: 800mA, electronic driver, DALI dimmable, electrical protection: CLASS I, IP20, suitable for internal environment only.

Product Overview

Product name	MC2 TRIM 2.4M 3K DALI WHT OPAL
Technology	LED (3 SDCM)
Cap/Base	N/A
Housing	Aluminium
Mount	Ceiling recessed mounting
General application	Education, Hospitality, Office, Retail
ETIM Class	EC002892
E-number FI	4170353
Fixture luminous flux (lm)	4600
Luminaire efficacy (lm/W)	128
LOR (%)	100
Colour temperature (K)	3000
Light colour	Warm White

Concord

MC2 TRIM 2.4M 3K DALI WHT OPAL 2071489

CRI (Ra)	80
Colour Variation Initial (SDCM)	3
Glare control	< 24
Photobiological Risk Group	RG0
Total power consumption (W)	36
Electrical protection	Class I
Control gear type	Electronic ballast
Dimmable	Yes
Minimum dimming level (%)	1
Housing colour	White
IP rating	IP20
IK rating	IK03
Product EAN number	5025768714896
Warranty	5 years
Useful luminous flux (#use)	4600
Dimming method	DALI

Photometry

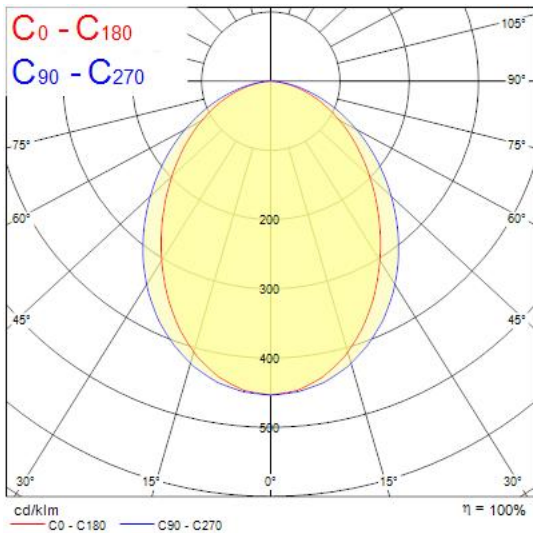

Technical drawings

