

Concord

MC2 TRIM 2.4M 3K DALI WHT OPAL 2071489

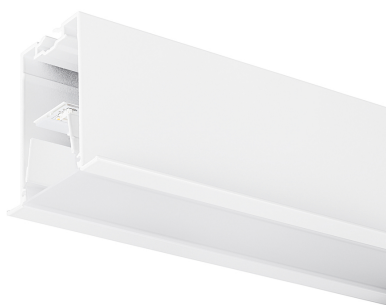

Features

- MC2 TRIM 2.4M 3K DALI WHT OPAL LED luminaire, white RAL9016 finishing, direct distribution, trim detail for plasterboard ceilings, suitable for recessed installation either horizontally or vertically, various accessories available, compact and minimalist design based on the Golden Mean, ideal for offices, meeting rooms, corridors, education facilities, museums and libraries, extruded aluminium body, diffuser: opal, colour temperature: 3000K warm white, total system power: 36W, total fixture output: 4600lm, luminaire efficacy: 128lm/W, LOR: 100%, colour rendering: Ra >80, LED Chromacity: 3 step MacAdam ellipse, lifespan: 66,000 hours L90B10, IR/UV free light source without heat radiation, operating voltage: 220-240V / 50-60Hz, drive current: 800mA, electronic driver, DALI dimmable, electrical protection: CLASS I, IP20, suitable for internal environment only.

Product Overview

Product name	MC2 TRIM 2.4M 3K DALI WHT OPAL
Technology	LED (3 SDCM)
Cap/Base	N/A
Housing	Aluminium
Mount	Ceiling recessed mounting
General application	Education, Hospitality, Office, Retail
ETIM Class	EC002892
E-number FI	4170353
Fixture luminous flux (lm)	4600
Luminaire efficacy (lm/W)	128
LOR (%)	100
Colour temperature (K)	3000
Light colour	Warm White

Concord

MC2 TRIM 2.4M 3K DALI WHT OPAL 2071489

CRI (Ra)	80
Colour Variation Initial (SDCM)	3
Glare control	< 24
Photobiological Risk Group	RG0
Total power consumption (W)	36
Electrical protection	Class I
Control gear type	Electronic ballast
Dimmable	Yes
Minimum dimming level (%)	1
Housing colour	White
IP rating	IP20
IK rating	IK03
Product EAN number	5025768714896
Warranty	5 years
Useful luminous flux (#use)	4600
Dimming method	DALI

Photometry

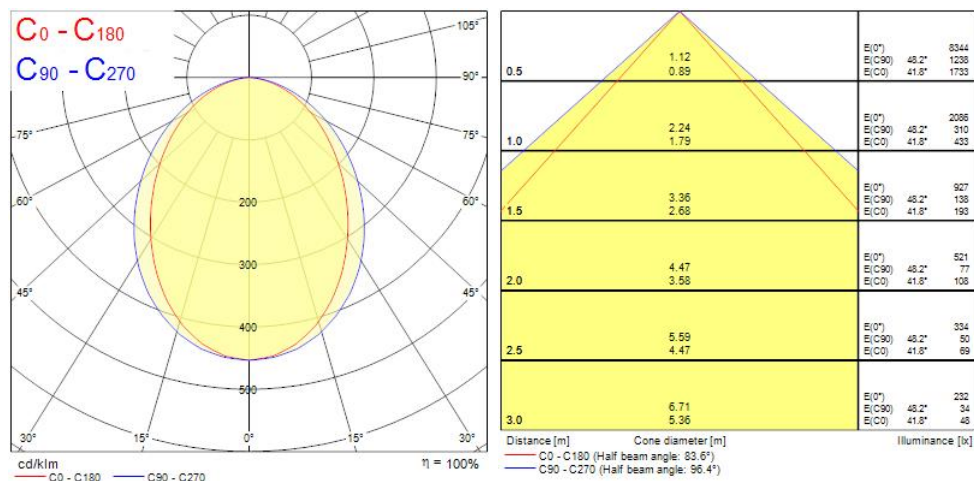

Concord

MC2 TRIM 2.4M 3K DALI WHT OPAL
2071489

Technical drawings

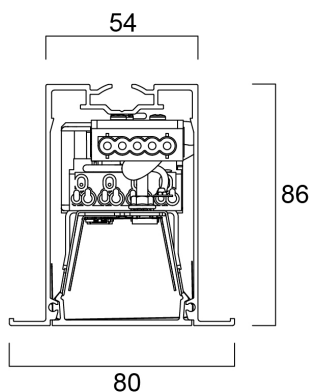

Data table

GENERAL DATA

Product name	MC2 TRIM 2.4M 3K DALI WHT OPAL
Technology	LED (3 SDCM)
Cap/Base	N/A
Housing	Aluminium
Mount	Ceiling recessed mounting
General application	Education, Hospitality, Office, Retail
Operating temperature range (°C)	1°C...+40°C
Performance ambient temperature Tq (°C)	25
ETIM Class	EC002892
E-number FI	4170353
Warranty	5 years

OPTICAL DATA

Useful luminous flux (#use)	4600
Fixture luminous flux (lm)	4600

Concord

MC2 TRIM 2.4M 3K DALI WHT OPAL 2071489

Luminaire efficacy (lm/W)	128
LOR (%)	100
Colour temperature (K)	3000
Light colour	Warm White
CRI (Ra)	80
Colour Variation Initial (SDCM)	3
Adjustable chromaticity	N
Luminous Intensity (cd)	2086
Distribution type	Symmetric
Glare control	< 24
Photobiological Risk Group	RG0

ELECTRICAL DATA

Total power consumption (W)	36
Primary Supply/Product voltage - min (V)	220.0
Primary Supply/Product voltage - max (V)	240
Lamp power factor	0.98
THD (at 230 V, 50 Hz, full load, at 100% dimming level) ≤ xx.x %	6.1
Electrical protection	Class I
Control gear required	No
Control gear type	Electronic ballast
Dimmable	Yes
Dimming method	DALI
Minimum dimming level (%)	1
Drive current - Range (mA)	350mA / 1050mA
Inrush Current (A)	40
Inrush Duration (µs)	178
Glow Wire Test (°C)	650
Energy Efficiency Class (A->G) of contained light source	C
Nominal Frequency (Hz)	50/60Hz
Max. products per 10A C Breaker	15
Max. products per 13A C Breaker	20
Max. products per 16A C Breaker	23

Concord

MC2 TRIM 2.4M 3K DALI WHT OPAL 2071489

Max. products per 20A C Breaker	30
Max. products per 10A B Breaker	9
Max. products per 13A B Breaker	12
Max. products per 16A B Breaker	14
Max. products per 20A B Breaker	18
Connectable conductor cross section - Max (mm ²)	1.5

LIFETIME DATA

Lifespan L70 B50	120000
Lifespan L80 B20	92500
Lifespan L90 B10	66000

PHYSICAL DATA

Housing colour	White
IP rating	IP20
IK rating	IK03
Diffuser finish	Opal
Diffuser material	PC Polycarbonate
Reflector finish	White
Nominal Product Length (mm)	2400
Nominal Product Width (mm)	80
Nominal Product Height (mm)	86
Cutout Dimensions (W x L in mm or Diameter in mm)	60 x 2400
Weight (kg)	5.6
Recessed Depth (mm)	136

PACKAGING

Product EAN number	5025768714896
Packaging single length / height (cm)	245.0
Packaging single width (cm)	9.0
Packaging single depth (cm)	10.0
DUN14 (outer)	05025768714896

Concord

MC2 TRIM 2.4M 3K DALI WHT OPAL
2071489

Units per outer package	1
Packaging outer length / height (cm)	245.0
Packaging outer width (cm)	9.0
Packaging outer depth (cm)	10.0

SAFETY DATA

Optimal operating condition (°C)	1-40
Special purpose lamp	No
Dry applications use only	No
Suitable for household illumination	No