

## Data Sheet | Item Number: 733-112/037-000

1-conductor female connector; CAGE CLAMP®; 0.5 mm<sup>2</sup>; Pin spacing 2.5 mm; 12-pole; 100% protected against mismatching; Lateral locking levers; light gray

<https://www.wago.com/733-112/037-000>



Color: ■ light gray

Similar to illustration

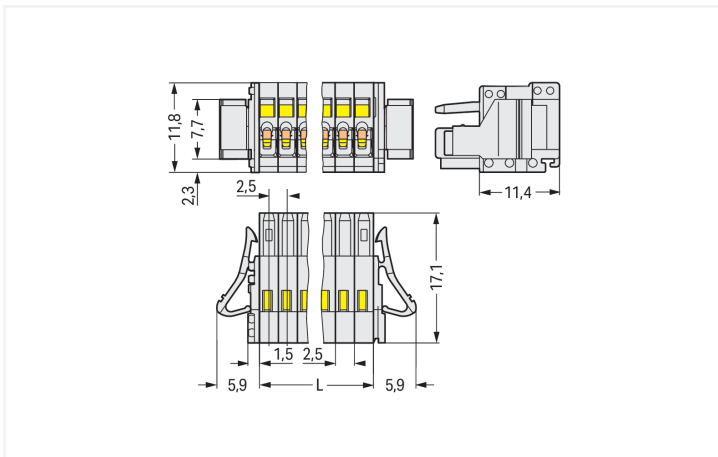
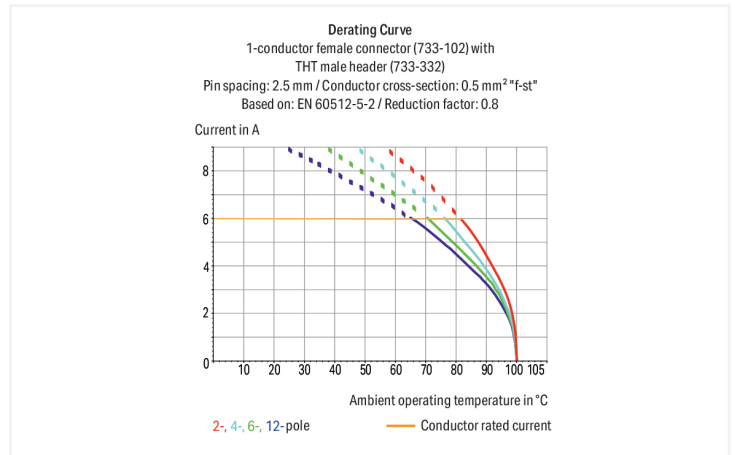

Dimensions in mm

L = pole no. x pin spacing

### Female connector, 733 Series, operating tool

This female connector (item number 733-112/037-000) is designed for fault-free electrical installations. Strip lengths must be between 5 and 6 mm when connecting conductors to this female connector. Featuring one conductor terminal along with CAGE CLAMP®, this connector outperforms the competition. Our CAGE CLAMP® connection offers a reliable and maintenance-free way to connect all types of conductors. You do not need to prepare the conductor in any way, such as crimping ferrules. The dimensions are (41.8 x 11.8 x 17.1) mm (width x height x depth). Depending on the type of conductor, this female connector is designed for conductor cross sections ranging from 0.08 mm<sup>2</sup> to 0.5 mm<sup>2</sup>.

The contact surface is coated with tin.

## Notes

## Safety Information

The MCS – MULTI CONNECTION SYSTEM includes connectors without breaking capacity in accordance with DIN EN 61984. When used as intended, these connectors must not be connected/disconnected when live or under load. When used as intended, these connectors must not be connected/disconnected when live or under load. The circuit design should ensure header pins, which can be touched, are not live when unmated.

## Variants:

Other pole numbers  
Gold-plated or partially gold-plated contact surfaces  
Other versions (or variants) can be requested from WAGO Sales or configured at <https://configurator.wago.com/>.

## Electrical data

Ratings per IEC/EN 60664-1				Approvals per UL 1059			
Overvoltage category	III	III	II	Use group	B	C	D
Pollution degree	3	2	2	Rated voltage	150 V	-	-
Nominal voltage	100 V	160 V	320 V	Rated current	4 A	-	-
Rated impulse withstand voltage	2.5 kV	2.5 kV	2.5 kV				
Rated current	6 A	6 A	6 A				

Approvals per CSA			
Use group	B	C	D
Rated voltage	150 V	-	-
Rated current	4 A	-	-

## Connection Data

Clamping units	12	<b>Connection 1</b>	
Total number of potentials	12	Connection technology	CAGE CLAMP®
Number of connection types	1	Actuation type	Operating tool
Number of levels	1	Actuation direction 1	Operation parallel to conductor entry
		Actuation direction 2	Operation perpendicular to conductor entry
		Solid conductor	0.08 ... 0.5 mm <sup>2</sup> / 28 ... 20 AWG
		Fine-stranded conductor	0.08 ... 0.5 mm <sup>2</sup> / 28 ... 20 AWG
		Fine-stranded conductor; with insulated ferrule	0.25 ... 0.34 mm <sup>2</sup>
		Fine-stranded conductor; with uninsulated ferrule	0.25 ... 0.34 mm <sup>2</sup>
		Strip length	5 ... 6 mm / 0.2 ... 0.24 inches
		Pole number	12
		Conductor entry direction to mating direction	0°

## Physical data

Pin spacing	2.5 mm / 0.098 inches
Width	41.8 mm / 1.646 inches
Height	11.8 mm / 0.465 inches
Depth	17.1 mm / 0.673 inches

### Mechanical data

Variable coding	Yes
Anti-rotation protection	Yes

### Plug-in connection

Contact type (pluggable connector)	Female connector/socket
Connector (connection type)	for conductor
Mismating protection	Yes
Locking of plug-in connection	Locking lever

### Material data

Note (material data)	<a href="#">Information on material specifications can be found here</a>
Color	light gray
Material group	I
Insulation material (main housing)	Polyamide (PA66)
Flammability class per UL94	V0
Clamping spring material	Chrome-nickel spring steel (CrNi)
Contact material	Copper alloy
Contact Plating	Tin
Fire load	0.102 MJ
Weight	5.6 g

### Environmental requirements

Limit temperature range	-60 ... +100 °C
Processing temperature	-35 ... +60 °C

### Environmental Testing

Test specification: Railway applications – Rolling stock – Electronic equipment	DIN EN 50155 (VDE 0115-200):2022-06
Test procedure: Railway applications – Rolling stock equipment – Vibration and shock tests	DIN EN 61373 (VDE 0115-0106):2011-04
Spectrum/Mounting location	Service life test, Category 1, Class A/B
Functional test with noise-like oscillations	Test passed according to Section 8 of the standard
Frequency	$f_1 = 5 \text{ Hz}$ to $f_2 = 150 \text{ Hz}$
Acceleration	0.101g (highest test level used for all axes)
Test duration per axis	10 min.
Test directions	X, Y and Z axes
Monitoring of contact faults and interruptions	Passed
Voltage drop measurement before and after each axis	Passed
Simulated service life test through increased levels of noise-like oscillations	Test passed according to Section 9 of the standard
Frequency	$f_1 = 5 \text{ Hz}$ to $f_2 = 150 \text{ Hz}$
Acceleration	0.572g (highest test level used for all axes)
Test duration per axis	5 h
Test directions	X, Y and Z axes
Extended testing: Monitoring of contact faults and interruptions	Passed
Extended testing: Voltage drop measurement before and after each axis	Passed
Shock test	Test passed according to Section 10 of the standard
Shock pulse form	Half sine

**Environmental Testing**

Acceleration	5g (highest test level used for all axes)
Shock duration	30 ms
Number of shocks (per axis)	3 pos. und 3 neg.
Test directions	X, Y and Z axes
Extended testing: Monitoring of contact faults and interruptions	Passed
Extended testing: Voltage drop measurement before and after each axis	Passed
Vibration and shock stress for rolling stock equipment	Passed

**Commercial data**

Product Group	3 (Multi Conn. System)
PU (SPU)	50 pcs
Packaging type	Box
Country of origin	DE
GTIN	4045454215682
Customs tariff number	85366990990

**Product Classification**

UNSPSC	39121409
eCl@ss 10.0	27-44-03-09
eCl@ss 9.0	27-44-03-09
ETIM 9.0	EC002638
ETIM 10.0	EC002638
ECCN	NO US CLASSIFICATION

**Environmental Product Compliance**

RoHS Compliance Status	Compliant, No Exemption
------------------------	-------------------------

**Approvals / Certificates**

**Declarations of conformity and manufacturer's declarations**



Approval	Standard	Certificate Name
Railway WAGO GmbH & Co. KG	-	Railway Ready

**Approvals for marine applications**



Approval	Standard	Certificate Name
BV Bureau Veritas S.A.	IEC 60998	11915/E0 BV

**Downloads**

**Environmental Product Compliance**

Compliance Search			
Environmental Product Compliance			↓
733-112/037-000			

**Documentation**

Additional Information			
Technical Section	03.04.2019	pdf 2027.26 KB	↓

**CAD/CAE-Data**

CAD data	
2D/3D Models	↓
733-112/037-000	

CAE data	
EPLAN Data Portal	↓
733-112/037-000	

ZUKEN Portal	↓
733-112/037-000	

**1 Compatible Products**

**1.1 System counterpart**

**1.1.1 Male connector/plug**



**Item No.: 733-212**  
1-conductor male connector; CAGE CLAMP®; 0.5 mm<sup>2</sup>; Pin spacing 2.5 mm; 12-pole; 100% protected against mismatching; light gray

**Item No.: 733-372**  
THT male header; 0.8 x 0.8 mm solder pin; angled; 100% protected against mismatching; Pin spacing 2.5 mm; 12-pole; light gray

**Item No.: 733-342**  
THT male header; 0.8 x 0.8 mm solder pin; straight; 100% protected against mismatching; Pin spacing 2.5 mm; 12-pole; light gray

**1.2 Optional Accessories**

**1.2.1 Ferrule**

**1.2.1.1 Ferrule**



**Item No.: 216-301**  
Ferrule; Sleeve for 0.25 mm<sup>2</sup> / AWG 24; insulated; electro-tin plated; yellow

**Item No.: 216-321**  
Ferrule; Sleeve for 0.25 mm<sup>2</sup> / AWG 24; insulated; electro-tin plated; yellow

**Item No.: 216-151**  
Ferrule; Sleeve for 0.25 mm<sup>2</sup> / AWG 24; uninsulated; electro-tin plated

**Item No.: 216-131**  
Ferrule; Sleeve for 0.25 mm<sup>2</sup> / AWG 24; uninsulated; electro-tin plated; silver-colored



**Item No.: 216-302**  
Ferrule; Sleeve for 0.34 mm<sup>2</sup> / 22 AWG; insulated; electro-tin plated; light turquoise

**Item No.: 216-322**  
Ferrule; Sleeve for 0.34 mm<sup>2</sup> / 22 AWG; insulated; electro-tin plated; light turquoise

**Item No.: 216-132**  
Ferrule; Sleeve for 0.34 mm<sup>2</sup> / AWG 24; uninsulated; electro-tin plated

**Item No.: 216-152**  
Ferrule; Sleeve for 0.34 mm<sup>2</sup> / AWG 24; uninsulated; electro-tin plated

## 1.2.2 Marking

### 1.2.2.1 Marking strip



**Item No.: [210-331/250-202](#)**

Marking strips; as a DIN A4 sheet; MARKED; 1-16 (400x); Height of marker strip: 2.3 mm/0.091 in; Strip length 182 mm; Horizontal marking; Self-adhesive; white



**Item No.: [210-331/250-207](#)**

Marking strips; as a DIN A4 sheet; MARKED; 1-48 (100x); Height of marker strip: 2.3 mm/0.091 in; Strip length 182 mm; Horizontal marking; Self-adhesive; white



**Item No.: [210-331/250-204](#)**

Marking strips; as a DIN A4 sheet; MARKED; 17-32 (400x); Height of marker strip: 2.3 mm/0.091 in; Strip length 182 mm; Horizontal marking; Self-adhesive; white



**Item No.: [210-331/250-206](#)**

Marking strips; as a DIN A4 sheet; MARKED; 33-48 (400x); Height of marker strip: 2.3 mm/0.091 in; Strip length 182 mm; Horizontal marking; Self-adhesive; white

## 1.2.3 Strain relief

### 1.2.3.1 Strain relief plate



**Item No.: [734-129](#)**

Strain relief plate; for female and male connectors; 25 mm wide; 1 part; Pin spacing 3.5 mm; light gray

## 1.2.4 Test and measurement

### 1.2.4.1 Testing accessories



**Item No.: [735-500](#)**

WAGO Test pin; 1 mm Ø; 30 V AC / 60 V DC; CAT0; 1 A; 6 mm uninsulated; Test lead for soldering up to 0,5mm<sup>2</sup>

## 1.2.5 Tool

### 1.2.5.1 Operating tool



**Item No.: [210-719](#)**

Operating tool; Blade: 2.5 x 0.4 mm; with a partially insulated shaft



**Item No.: [210-251](#)**

Operating tool; for MCS MICRO and MINI with CAGE CLAMP® connection; yellow



**Item No.: [233-335](#)**

Operating tool; green



**Item No.: [233-331](#)**

Operating tool; insulated; yellow



**Item No.: [733-130](#)**

Operating tool; made of insulating material; 1-way; loose; white



**Item No.: [733-191](#)**

Operating tool; made of insulating material; 1-way; loose; yellow



**Item No.: [233-332](#)**

Operating tool; made of insulating material; white

## Installation Notes

### Mismating protection



Male headers and female connectors are 100% protected against mismating. Only mating halves with the same pole number can be connected.

### Conductor termination

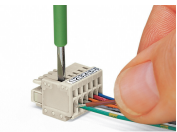

Inserting conductor via (2.5 x 0.4) mm screwdriver – CAGE CLAMP® actuation perpendicular to conductor entry.

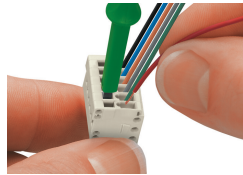

Conductor termination via screwdriver (233-335) – parallel to CAGE CLAMP® actuation

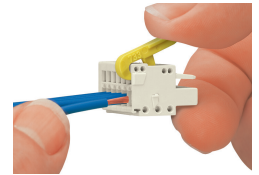

Conductor termination via operating tool (733-191)

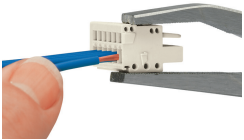

Conductor termination via operating tool (210-251)

### Coding



Coding a female connector – removing coding finger(s).

### Marking



## Strain relief

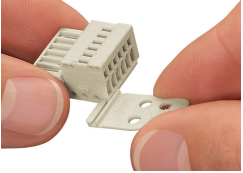

Strain relief plates for factory or in-the-field assembly

## Testing

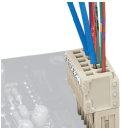

Testing via 1 mm Ø test pin (735-500), touch contact.

## Locking system



Locking levers prevent accidental disconnection.

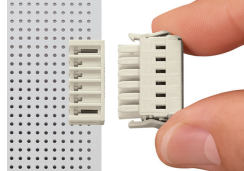

Locking levers prevent accidental disconnection.