

Data Sheet | Item Number: 261-210/332-000

4-conductor terminal strip; on one side with push-buttons; with fixing flanges; 10-pole; for screw or similar mounting types; Fixing hole 3.2 mm Ø; 2.5 mm²; CAGE CLAMP®; gray

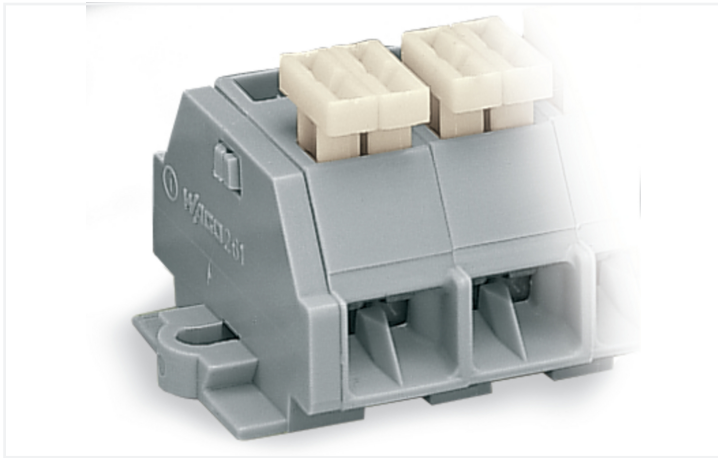

<https://www.wago.com/261-210/332-000>



Color: ■ gray

Similar to illustration

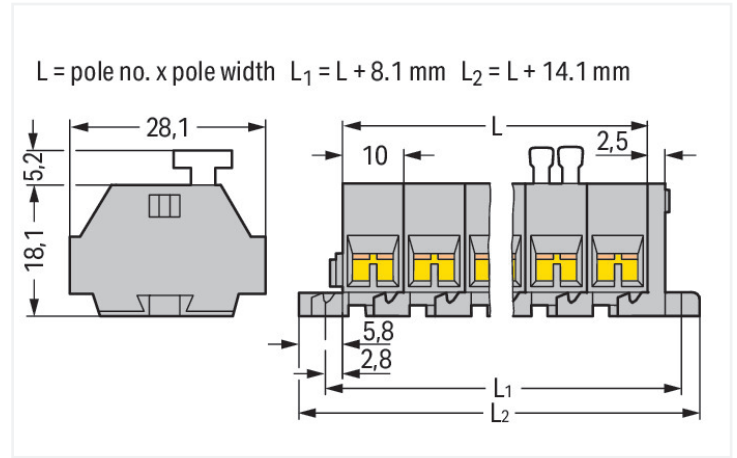

Dimensions in mm

Through terminal block, 261 Series, Push-button

Our through terminal block (item number 261-210/332-000) is the ideal way to connect conductors quickly and securely. Strip lengths must be between 8 and 9 mm when connecting conductors to this through terminal block. Our mini rail-mount terminal blocks are the perfect choice for working in confined spaces. A large selection of mounting and actuation variants means you can find a suitable mini terminal block for every purpose. This also means you can adapt the terminal blocks to your unique requirements. Featuring conductor terminals along with CAGE CLAMP®, this connector is highly versatile. Our reliable and maintenance-free CAGE CLAMP® connection makes it easy to connect all conductor types without having to prepare the conductor. For example, you don't need to crimp ferrules. The dimensions are (114.1 x 28.1 x 23.3) mm (width x height x depth). This through terminal block is suitable for conductor cross sections ranging from 0.08 mm² to 2.5 mm².

Operating tool, push-button is used to operate this mini rail-mount terminal block.

Electrical data

Ratings per IEC/EN

Nominal voltage (III/3)	500 V
Rated impulse withstand voltage (III / 3)	6 kV
Rated current	24 A
Legend (ratings)	(III / 3) ≙ Overvoltage category III / Pollution degree 3

Approvals per

UL 1059

Use group	B	C	D
Rated voltage	300 V	300 V	600 V
Rated current	15 A	15 A	5 A

Approvals per

CSA 22.2 No 158

Use group	B	C	D
Rated voltage	-	300 V	600 V
Rated current	-	10 A	5 A

General information

Wiring direction Side-entry wiring

Connection Data

Clamping units	40
Total number of potentials	10
Number of levels	1

Connection 1

Connection technology	CAGE CLAMP®
Actuation type	Operating tool
Connectable conductor materials	Copper
Solid conductor	0.08 ... 2.5 mm ² / 28 ... 14 AWG
Fine-stranded conductor	0.08 ... 2.5 mm ² / 28 ... 14 AWG
Strip length	8 ... 9 mm / 0.31 ... 0.35 inches
Pole number	10
Wiring direction	Side-entry wiring

Connection 2

Actuation type	Push-button
----------------	-------------

Physical data

Width	114.1 mm / 4.492 inches
Height	28.1 mm / 1.106 inches
Depth	23.3 mm / 0.917 inches
Module width	10 mm / 0.394 inches

Mechanical data

Design	horizontal type
Mounting type	Mounting flange
Marking level	Side marking

Material data

Note (material data)	Information on material specifications can be found here
Color	gray
Material group	I
Insulation material (main housing)	Polyamide (PA66)
Flammability class per UL94	V0
Fire load	0.863 MJ
Halogen-free	Yes
Weight	42.8 g

Commercial data

PU (SPU)	50 pcs
Packaging type	Box
Country of origin	DE
GTIN	4045454046576
Customs tariff number	85369010000

Product Classification

UNSPSC	39121410
eCl@ss 10.0	27-14-11-06
eCl@ss 9.0	27-14-11-06
ETIM 9.0	EC001284
ETIM 10.0	EC001284
ECCN	NO US CLASSIFICATION

Environmental Product Compliance

RoHS Compliance Status	Compliant, No Exemption
------------------------	-------------------------

Approvals / Certificates

General approvals **Declarations of conformity and manufacturer's declarations**



Approval	Standard	Certificate Name
CCA DEKRA Certification B.V.	EN 60998	NTR-NL 6509
KEMA/KEUR DEKRA Certification B.V.	EN 60998	2110272.02

Approval	Standard	Certificate Name
EU-Declaration of Conformity WAGO GmbH & Co. KG	-	-
UK-Declaration of Conformity WAGO GmbH & Co. KG	-	-

Approvals for marine applications



Approval	Standard	Certificate Name
ABS American Bureau of Shipping	-	24-0095979-PDA

Downloads

Environmental Product Compliance

Compliance Search	
Environmental Product Compliance 261-210/332-000	↓

Documentation

Bid Text			
261-210/332-000	19.02.2019	xml 3.15 KB	↓
261-210/332-000	16.08.2017	doc 24.50 KB	↓

CAD/CAE-Data

CAD data	CAE data
2D/3D Models 261-210/332-000	EPLAN Data Portal 261-210/332-000
	WSCAD Universe 261-210/332-000
	ZUKEN Portal 261-210/332-000

1 Compatible Products

1.1 Optional Accessories

1.1.1 Ferrule

1.1.1.1 Ferrule

Item No.: 216-301 Ferrule; Sleeve for 0.25 mm ² / AWG 24; insulated; electro-tin plated; yellow	Item No.: 216-302 Ferrule; Sleeve for 0.34 mm ² / 22 AWG; insulated; electro-tin plated; light turquoise	Item No.: 216-201 Ferrule; Sleeve for 0.5 mm ² / 20 AWG; insulated; electro-tin plated; electrolytic copper; acc. to DIN 46228, Part 4/09.90; white	Item No.: 216-101 Ferrule; Sleeve for 0.5 mm ² / AWG 22; un-insulated; electro-tin plated; silver-colored
Item No.: 216-202 Ferrule; Sleeve for 0.75 mm ² / 18 AWG; insulated; electro-tin plated; gray	Item No.: 216-102 Ferrule; Sleeve for 0.75 mm ² / AWG 20; un-insulated; electro-tin plated; silver-colored	Item No.: 216-203 Ferrule; Sleeve for 1 mm ² / AWG 18; insulated; electro-tin plated; red	Item No.: 216-103 Ferrule; Sleeve for 1 mm ² / AWG 18; un-insulated; electro-tin plated
Item No.: 216-204 Ferrule; Sleeve for 1.5 mm ² / AWG 16; insulated; electro-tin plated; black	Item No.: 216-104 Ferrule; Sleeve for 1.5 mm ² / AWG 16; un-insulated; electro-tin plated; silver-colored	Item No.: 216-205 Ferrule; Sleeve for 2.08 mm ² / AWG 14; insulated; electro-tin plated; yellow	Item No.: 216-206 Ferrule; Sleeve for 2.5 mm ² / AWG 14; insulated; electro-tin plated; blue
Item No.: 216-106 Ferrule; Sleeve for 2.5 mm ² / AWG 14; un-insulated; electro-tin plated; silver-colored			

1.1.2 Installation

1.1.2.1 Mounting accessories

Item No.: 209-137 Mounting adapter; can be used as end stop; 6.5 mm wide; gray	Item No.: 209-123 Mounting foot with screw; can be screwed on terminal blocks with fixing flange; 6.4 mm wide; gray

1.1.3 Jumper

1.1.3.1 Jumper



Item No.: 261-402

Jumper; for conductor entry; 2-way; insulated; gray

1.1.4 Marking

1.1.4.1 Marking strip



Item No.: 210-833

Marking strips; 25 m on roll; 6 mm wide; plain; Self-adhesive; white

1.1.5 Tool

1.1.5.1 Operating tool



Item No.: 210-658

Operating tool; Blade: 3.5 x 0.5 mm; with a partially insulated shaft; angled; short; multicoloured



Item No.: 210-720

Operating tool; Blade: 3.5 x 0.5 mm; with a partially insulated shaft; multicoloured



Item No.: 210-657

Operating tool; Blade: 3.5 x 0.5 mm; with a partially insulated shaft; short; multicoloured

Installation Notes

Conductor termination

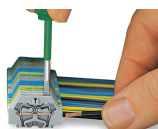

CAGE CLAMP® connection

Inserting a conductor.
With ferruled conductors, it is necessary to use a terminal block one size larger than the conductor's nominal cross-section.

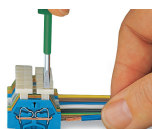

CAGE CLAMP® connection

Inserting a conductor via push-button.

Commoning

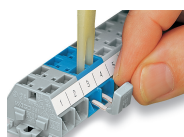

Commoning with comb-style jumper bar.

Installation

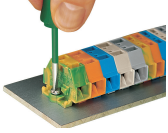

Mounting and securing a terminal strip directly to the plate via screw-type flanges.

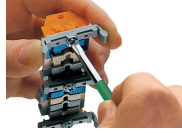

Terminal strip with mounting flanges
Screwing a mounting foot (209-123).
(Distance between mounting feet: approx. 25 ... 30 mm)

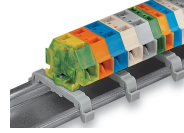

Terminal strip; with mounting flanges; for DIN-35 rail



Terminal strip with mounting flanges, for screw or similar mounting types, 3.2 mm mounting hole diameter (with 209-123 Mounting Foot also for DIN-35 rail)

Marking



Marking with self-adhesive marking strips.



Marking by direct printing (upon request).