

Product data

Product code	VC01-0011	STK-code	1912019	EAN-code	6410019120196
Product name	OL2x50-150			ETIM class	EC000897
Wires	2xAl/Cu 50-150 mm ²				

Technical data

Nominal current (IEC)	Cu	579	A
	Al	455	A
		-	
		-	
		-	
		-	
Number of poles		1	pcs
Max. Cross section		150	mm ²
Tightening torque			
	50-150 mm ²	40	Nm
		-	
		-	
		-	
Operating temperature		80	°C
Weight		240	g
		-	



Standards	UL 486E
Color / Material	Stainless steel/ Tin plated copper
Mounting / Connection	Screw M10

Description

OL-connectors are designed to be used connecting aluminium and copper conductors. Frames are made of stainless steel and busbars of tin plated copper.

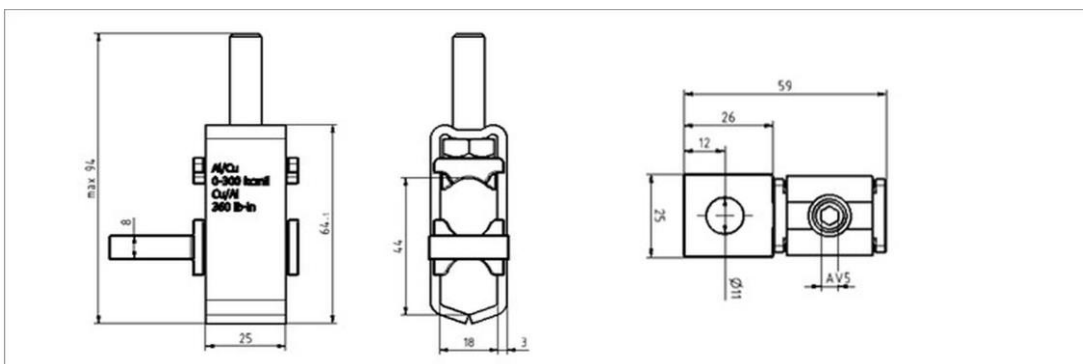
Drawing

Package

Package	Box	Pcs / Package	3	Weight [kg]	0,74
Length [mm]	86	Width [mm]	68	Height [mm]	82

Ouneva Oy

Teollisuustie 21
FI-82730 Tuupovaara
Finland

www.ounevagroup.fi

www.ounevaproducts.fi