

## Data Sheet | Item Number: 731-612/019-000

1-conductor male connector; CAGE CLAMP®; 2.5 mm<sup>2</sup>; Pin spacing 7.5 mm; 12-pole; clamping collar; 2,50 mm<sup>2</sup>; gray

<https://www.wago.com/731-612/019-000>



Color: ■ gray

Similar to illustration

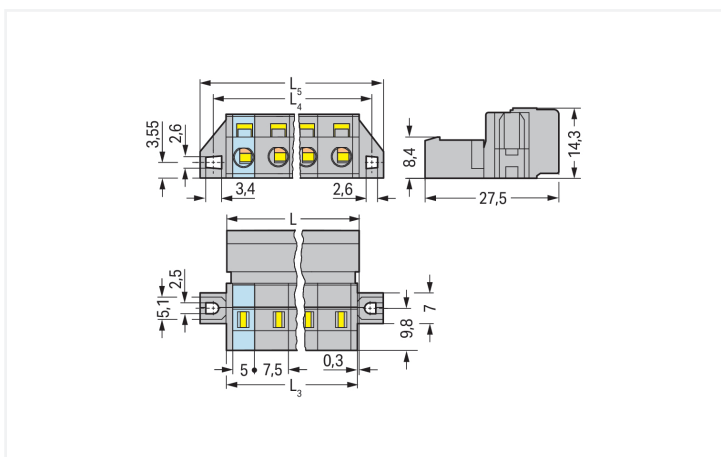
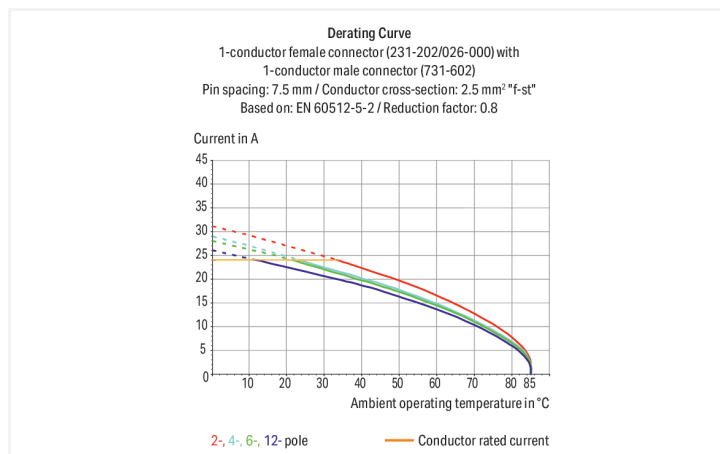

Dimensions in mm

$L = (\text{pole no.} - 1) \times \text{pin spacing} + 8.2 \text{ mm}$   
 $L_3 = L - 0.2 \text{ mm}$   
 $L_4 = L_3 + 5.8 \text{ mm}$   
 $L_5 = L_3 + 11.8 \text{ mm}$

Male connector, 731 Series, with 7.5 mm pin spacing

Our male connector (item number 731-612/019-000) ensures effortless electrical installations. Strip lengths must be between 8 and 9 mm when connecting conductors to this male connector. Featuring one conductor terminal along with CAGE CLAMP®, this connector is highly versatile. Our CAGE CLAMP® connection provides a safe and maintenance-free way to connect all types of conductors. You do not need to prepare the conductor in any way, such as crimping ferrules. The item's dimensions are (102.3 x 14.3 x 27.5) mm (width x height x depth). This male connector is suitable for conductor cross sections ranging from 0.08 mm<sup>2</sup> to 2.5 mm<sup>2</sup>.

The contact surface is coated with tin.

## Notes

## Safety Information

The MCS – MULTI CONNECTION SYSTEM includes connectors without breaking capacity in accordance with DIN EN 61984. When used as intended, these connectors must not be connected/disconnected when live or under load. When used as intended, these connectors must not be connected/disconnected when live or under load. The circuit design should ensure header pins, which can be touched, are not live when unmated.

## Variants:

Other pole numbers  
Gold-plated or partially gold-plated contact surfaces  
Other versions (or variants) can be requested from WAGO Sales or configured at <https://configurator.wago.com/>.

## Electrical data

Ratings per IEC/EN 60664-1				Approvals per UL 1059			
	III	III	II	Use group	B	C	D
Overvoltage category	III	III	II	Rated voltage	300 V	-	300 V
Pollution degree	3	2	2	Rated current	15 A	-	10 A
Nominal voltage	500 V	630 V	1000 V				
Rated impulse withstand voltage	6 kV	6 kV	6 kV				
Rated current	12 A	12 A	12 A				

Approvals per UL 1977		Approvals per CSA			
	600 V	Use group	B	C	D
Rated voltage	600 V	Rated voltage	300 V	-	300 V
Rated current	15 A	Rated current	15 A	-	10 A

## Connection Data

Clamping units	12	<b>Connection 1</b>	
Total number of potentials	12	Connection technology	CAGE CLAMP®
Number of connection types	1	Actuation type	Operating tool
Number of levels	1	Actuation direction 1	Operation parallel to conductor entry
		Actuation direction 2	Operation perpendicular to conductor entry
		Solid conductor	0.08 ... 2.5 mm <sup>2</sup> / 28 ... 12 AWG
		Fine-stranded conductor	0.08 ... 2.5 mm <sup>2</sup> / 28 ... 12 AWG
		Fine-stranded conductor; with insulated ferrule	0.25 ... 1.5 mm <sup>2</sup>
		Fine-stranded conductor; with uninsulated ferrule	0.25 ... 2.5 mm <sup>2</sup>
		Strip length	8 ... 9 mm / 0.31 ... 0.35 inches
		Pole number	12
		Conductor entry direction to mating direction	0°

## Physical data

Pin spacing	7.5 mm / 0.295 inches
Width	102.3 mm / 4.028 inches
Height	14.3 mm / 0.563 inches
Depth	27.5 mm / 1.083 inches

### Mechanical data

Variable coding	Yes
Mounting type	Mounting flange
Mounting type	Feed-through mounting Panel mounting
Anti-rotation protection	Yes
Suitable for through-panel applications	Yes

### Plug-in connection

Contact type (pluggable connector)	Male connector/plug
Connector (connection type)	for conductor
Mismating protection	No

### Material data

Note (material data)	<a href="#">Information on material specifications can be found here</a>
Color	gray
Material group	I
Insulation material (main housing)	Polyamide (PA66)
Flammability class per UL94	V0
Clamping spring material	Chrome-nickel spring steel (CrNi)
Contact material	Electrolytic copper (E <sub>CU</sub> )
Contact Plating	Tin
Fire load	0.455 MJ
Weight	22.9 g

### Environmental requirements

Limit temperature range	-60 ... +100 °C	<b>Environmental Testing</b>	
Processing temperature	-35 ... +60 °C	Test specification: Railway applications – Rolling stock – Electronic equipment	DIN EN 50155 (VDE 0115-200):2022-06
		Test procedure: Railway applications – Rolling stock equipment – Vibration and shock tests	DIN EN 61373 (VDE 0115-0106):2011-04
		Spectrum/Mounting location	Service life test, Category 1, Class A/B
		Functional test with noise-like oscillations	Test passed according to Section 8 of the standard
		Frequency	f <sub>1</sub> = 5 Hz to f <sub>2</sub> = 150 Hz
		Acceleration	0.101g (highest test level used for all axes)
		Test duration per axis	10 min.
		Test directions	X, Y and Z axes
		Monitoring of contact faults and interruptions	Passed
		Voltage drop measurement before and after each axis	Passed
		Simulated service life test through increased levels of noise-like oscillations	Test passed according to Section 9 of the standard
		Frequency	f <sub>1</sub> = 5 Hz to f <sub>2</sub> = 150 Hz
		Acceleration	0.572g (highest test level used for all axes)
		Test duration per axis	5 h
		Test directions	X, Y and Z axes
		Extended testing: Monitoring of contact faults and interruptions	Passed
		Extended testing: Voltage drop measurement before and after each axis	Passed

### Environmental Testing

Shock test	Test passed according to Section 10 of the standard
Shock pulse form	Half sine
Acceleration	5g (highest test level used for all axes)
Shock duration	30 ms
Number of shocks (per axis)	3 pos. und 3 neg.
Test directions	X, Y and Z axes
Extended testing: Monitoring of contact faults and interruptions	Passed
Extended testing: Voltage drop measurement before and after each axis	Passed
Vibration and shock stress for rolling stock equipment	Passed

### Commercial data

Product Group	3 (Multi Conn. System)
PU (SPU)	10 pcs
Packaging type	Box
Country of origin	DE
GTIN	4044918267304
Customs tariff number	85366930000

### Product Classification

UNSPSC	39121409
eCl@ss 10.0	27-44-03-09
eCl@ss 9.0	27-44-03-09
ETIM 9.0	EC002638
ETIM 10.0	EC002638
ECCN	NO US CLASSIFICATION

### Environmental Product Compliance

RoHS Compliance Status	Compliant, No Exemption
------------------------	-------------------------

### Approvals / Certificates

#### General approvals



Approval	Standard	Certificate Name
CB DEKRA Certification B.V.	IEC 61984	NL-113351
KEMA/KEUR DEKRA Certification B.V.	EN 61984	71-130478 REV.1
UR Underwriters Laboratories Inc.	UL 1977	E 45171
UR Underwriters Laboratories Inc.	UL 1059	E45172

#### Declarations of conformity and manufacturer's declarations



Approval	Standard	Certificate Name
Railway WAGO GmbH & Co. KG	-	Railway Ready

Approvals for marine applications



Approval	Standard	Certificate Name
ABS American Bureau of Ship- ping	-	24-0095975-PDA
BV Bureau Veritas S.A.	IEC 60998	11915/E0 BV
DNV DNV GL SE	-	TAE000016Z
PRS Polski Rejestr Statków	-	TE/1095/880590/23

Downloads

Environmental Product Compliance

Compliance Search
Environmental Product Compliance 731-612/019-000

Documentation

Additional Information			
Technical Section	03.04.2019	pdf 2027.26 KB	

CAD/CAE-Data

CAD data
2D/3D Models 731-612/019-000

CAE data
EPLAN Data Portal 731-612/019-000
ZUKEN Portal 731-612/019-000

1 Compatible Products

1.1 System counterpart

1.1.1 Female connector/socket



**Item No.: 231-212/026-000**  
1-conductor female connector; CAGE  
CLAMP®; 2.5 mm<sup>2</sup>; Pin spacing 7.5 mm;  
12-pole; gray



**Item No.: 232-842**  
THT female header; angled; Pin spacing  
7.5 mm; 12-pole; 0.6 x 1.0 mm solder pin;  
gray



**Item No.: 232-742**  
THT female header; straight; Pin spacing  
7.5 mm; 12-pole; 0.6 x 1.0 mm solder pin;  
gray

## 1.2 Optional Accessories

### 1.2.1 Coding

#### 1.2.1.1 Coding



**Item No.: 231-130**

Coding key; snap-on type; light gray

### 1.2.2 Cover

#### 1.2.2.1 Cover



**Item No.: 231-668**

Lockout caps; for covering unused clamping units; gray

### 1.2.3 Ferrule

#### 1.2.3.1 Ferrule



**Item No.: 216-301**

Ferrule; Sleeve for 0.25 mm<sup>2</sup> / AWG 24; insulated; electro-tin plated; yellow



**Item No.: 216-302**

Ferrule; Sleeve for 0.34 mm<sup>2</sup> / 22 AWG; insulated; electro-tin plated; light turquoise



**Item No.: 216-201**

Ferrule; Sleeve for 0.5 mm<sup>2</sup> / 20 AWG; insulated; electro-tin plated; electrolytic copper; acc. to DIN 46228, Part 4/09.90; white



**Item No.: 216-241**

Ferrule; Sleeve for 0.5 mm<sup>2</sup> / 20 AWG; insulated; electro-tin plated; electrolytic copper; gastight crimped; acc. to DIN 46228, Part 4/09.90; white



**Item No.: 216-141**

Ferrule; Sleeve for 0.5 mm<sup>2</sup> / 20 AWG; un-insulated; electro-tin plated; electrolytic copper; gastight crimped; acc. to DIN 46228, Part 1/08.92



**Item No.: 216-101**

Ferrule; Sleeve for 0.5 mm<sup>2</sup> / AWG 22; un-insulated; electro-tin plated; silver-colored



**Item No.: 216-242**

Ferrule; Sleeve for 0.75 mm<sup>2</sup> / 18 AWG; insulated; electro-tin plated; electrolytic copper; gastight crimped; acc. to DIN 46228, Part 4/09.90; gray



**Item No.: 216-262**

Ferrule; Sleeve for 0.75 mm<sup>2</sup> / 18 AWG; insulated; electro-tin plated; electrolytic copper; gastight crimped; acc. to DIN 46228, Part 4/09.90; gray



**Item No.: 216-202**

Ferrule; Sleeve for 0.75 mm<sup>2</sup> / 18 AWG; insulated; electro-tin plated; gray



**Item No.: 216-142**

Ferrule; Sleeve for 0.75 mm<sup>2</sup> / 18 AWG; un-insulated; electro-tin plated; electrolytic copper; gastight crimped; acc. to DIN 46228, Part 1/08.92



**Item No.: 216-102**

Ferrule; Sleeve for 0.75 mm<sup>2</sup> / AWG 20; un-insulated; electro-tin plated; silver-colored



**Item No.: 216-243**

Ferrule; Sleeve for 1 mm<sup>2</sup> / AWG 18; insulated; electro-tin plated; electrolytic copper; gastight crimped; acc. to DIN 46228, Part 4/09.90; red



**Item No.: 216-263**

Ferrule; Sleeve for 1 mm<sup>2</sup> / AWG 18; insulated; electro-tin plated; electrolytic copper; gastight crimped; acc. to DIN 46228, Part 4/09.90; red



**Item No.: 216-203**

Ferrule; Sleeve for 1 mm<sup>2</sup> / AWG 18; insulated; electro-tin plated; red



**Item No.: 216-103**

Ferrule; Sleeve for 1 mm<sup>2</sup> / AWG 18; un-insulated; electro-tin plated



**Item No.: 216-143**

Ferrule; Sleeve for 1 mm<sup>2</sup> / AWG 18; un-insulated; electro-tin plated; electrolytic copper; gastight crimped; acc. to DIN 46228, Part 1/08.92



**Item No.: 216-204**

Ferrule; Sleeve for 1.5 mm<sup>2</sup> / AWG 16; insulated; electro-tin plated; black



**Item No.: 216-244**

Ferrule; Sleeve for 1.5 mm<sup>2</sup> / AWG 16; insulated; electro-tin plated; electrolytic copper; gastight crimped; acc. to DIN 46228, Part 4/09.90; black



**Item No.: 216-264**

Ferrule; Sleeve for 1.5 mm<sup>2</sup> / AWG 16; insulated; electro-tin plated; electrolytic copper; gastight crimped; acc. to DIN 46228, Part 4/09.90; black



**Item No.: 216-284**

Ferrule; Sleeve for 1.5 mm<sup>2</sup> / AWG 16; insulated; electro-tin plated; electrolytic copper; gastight crimped; acc. to DIN 46228, Part 4/09.90; black



**Item No.: 216-144**

Ferrule; Sleeve for 1.5 mm<sup>2</sup> / AWG 16; un-insulated; electro-tin plated; electrolytic copper; gastight crimped; acc. to DIN 46228, Part 1/08.92; silver-colored



**Item No.: 216-104**

Ferrule; Sleeve for 1.5 mm<sup>2</sup> / AWG 16; un-insulated; electro-tin plated; silver-colored



**Item No.: 216-106**

Ferrule; Sleeve for 2.5 mm<sup>2</sup> / AWG 14; un-insulated; electro-tin plated; silver-colored

## 1.2.4 Installation

### 1.2.4.1 Mounting accessories



**Item No.: 231-295**  
Screw with nut



**Item No.: 231-195**  
Screw with nut; M2x12; for fixing element



**Item No.: 209-147**  
Self-tapping screw



**Item No.: 231-194**  
Self-tapping screw; B 2.2x13, fixing hole 1.8 mm Ø

## 1.2.5 Insulation stop

### 1.2.5.1 Insulation stop



**Item No.: 231-673**  
Insulation stop; 0.08-0.2 mm<sup>2</sup> / 0.2 mm<sup>2</sup> "s"; white



**Item No.: 231-674**  
Insulation stop; 0.25 - 0.5 mm<sup>2</sup>; light gray



**Item No.: 231-675**  
Insulation stop; 0.75 - 1 mm<sup>2</sup>; dark gray

## 1.2.6 Marking

### 1.2.6.1 Marking strip



**Item No.: 210-331/750-202**  
Marking strips; as a DIN A4 sheet; MARKED; 1-16 (100x); Height of marker strip: 2.3 mm/0.091 in; Strip length 182 mm; Horizontal marking; Self-adhesive; white



**Item No.: 210-332/750-020**  
Marking strips; as a DIN A4 sheet; MARKED; 1-20 (80x); Height of marker strip: 3 mm; Strip length 182 mm; Horizontal marking; Self-adhesive; white

## 1.2.7 Tool

### 1.2.7.1 Operating tool



**Item No.: 210-720**  
Operating tool; Blade: 3.5 x 0.5 mm; with a partially insulated shaft; multicoloured



**Item No.: 210-657**  
Operating tool; Blade: 3.5 x 0.5 mm; with a partially insulated shaft; short; multicoloured



**Item No.: 231-291**  
Operating tool; made of insulating material; 1-way; loose; red



**Item No.: 231-131**  
Operating tool; made of insulating material; 1-way; loose; white

## Installation Notes

### Conductor termination

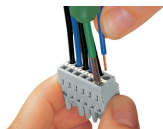

Inserting a conductor via 3.5 mm screwdriver – CAGE CLAMP® actuation parallel to conductor entry.

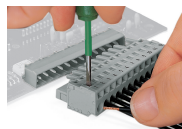

Inserting a conductor via 3.5 mm screwdriver – CAGE CLAMP® actuation perpendicular to conductor entry.

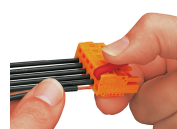

Inserting a conductor into CAGE CLAMP® unit via operating tool (231-291).



Inserting a conductor via operating tool.

## Coding

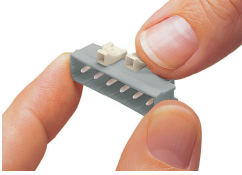

Coding a male header – fitting coding key (s).

## Testing

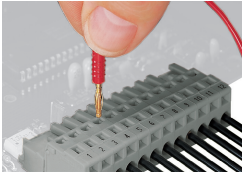

Testing – female connector with CAGE CLAMP®  
Integrated test ports for testing perpendicular to conductor entry via 2 or 2.3 mm Ø test plug

## Installation



Male connector with strain relief plate



Strain relief housing shown with a male connector equipped with CAGE CLAMP®

## Marking

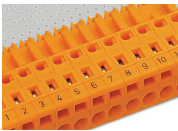

Labeling via direct marking or self-adhesive strips.