

Signalling Light SAM and SAM-LED

Optical signalling device for danger zones

- ▶ Protection degree IP 54
- ▶ SAM with 60 Watt VAL lamp
- ▶ SAM-LED with energy-saving LED modules

Application

The signalling light is used to regulate traffic in danger zones like, for example, gateways, parking lots or track systems. It is also used in filling plants and as status indicators for machines.

Design

The housing, front plates and sun-screens are made of high-grade, highly UV-resistant plastic. The dispersion lenses are sealed against dust and water with a heat and cold-resistant neoprene rubber gasket. The lamp consists of a VAL 60 Watt traffic signalling bulb (SAM). Or an energy-saving LED module (SAM-LED).

Traffic control in an open-pit mine

The dispersion lenses are sealed against dust and water with a heat and cold-resistant neoprene rubber gasket.



Technical specifications

Housing	UV-resistant plastic
Colour	Light grey
Front plate	UV-resistant plastic
Colour	Black
Protection degree	IP 54 (IEC 529)
Light source	VAL 60 Watt, 230 V (SAM) LED module (SAM-LED)
Dispersion lens	200 mm Ø
Temperature range	-20 °C to + 60 °C
Weight	1-element 2.0 kg 2-element 3.2 kg 3-element 4.7 kg

Current consumption SAM-LED

	red	yellow	green
230 V	60 mA	60 mA	70 mA
24 V	150 mA	150 mA	275 mA

Note on the SAM:

Through exchanging the VAL 60 W, 230 V bulb for an E 27, 24V bulb, the traffic lights can also be used at a supply voltage of 24 VDC.

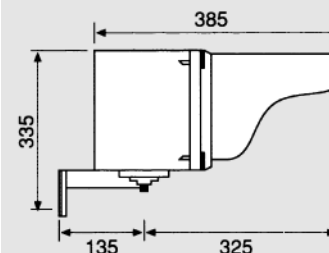
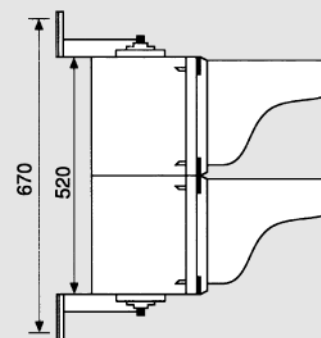
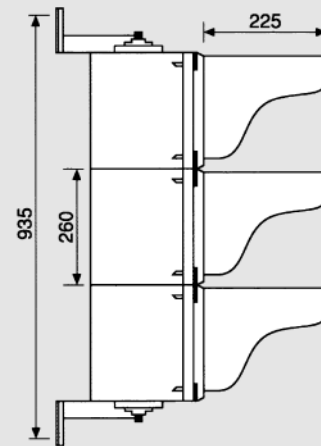

Note:

Versions with dispersion lenses 100 or 300 mm in diameter and other dispersion lens colours and symbols available on request.

Order information

Type	Name	Version	Rated voltage V	Article no.
SAM	Signalling Light	1-element with red dispersion lens	230 VAC	221 313 01
SAM	Signalling Light	2-element with red and green dispersion lenses	230 VAC	221 314 01
SAM	Signalling Light	3-element with red, yellow and green dispersion lenses	230 VAC	221 315 01
SAM-LED	Signalling Light	1-element with red dispersion lens	230 VAC	221 413 010
SAM-LED	Signalling Light	2-element with red and green dispersion lenses	230 VAC	221 414 010
SAM-LED	Signalling Light	3-element with red, yellow and green dispersion lenses	230 VAC	221 415 010
SAM-LED	Signalling Light	1-element with red dispersion lens	24 VDC	221 513 010
SAM-LED	Signalling Light	2-element with red and green dispersion lenses	24 VDC	221 514 010
SAM-LED	Signalling Light	3-element with red, yellow and green dispersion lenses	24 VDC	221 515 010

Subject to change without notice · Printout 10/11