

# Data Sheet | Item Number: 826-161/000-006

Feedthrough terminal block; Conductor/conductor connection; Plate thickness: 1 ...  
4 mm; 4 mm<sup>2</sup>; Pin spacing 7 mm; 1-pole; CAGE CLAMP®; 4,00 mm<sup>2</sup>; blue

<https://www.wago.com/826-161/000-006>

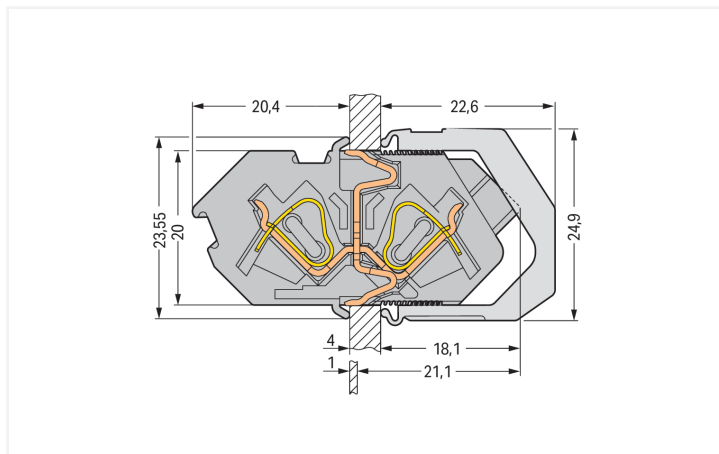

Color: ■ blue

Similar to illustration

Dimensions in mm

Cut-out dimensions: H = 20.1+0.1 mm; L = (pole no. x 7 mm) + 1.6+0.1 mm

Feedthrough terminal block, 826 Series, with 7 mm pin spacing

Feedthrough terminal block (item number 826-161/000-006) is designed for seamless electrical installations. Strip lengths must be between 9 and 10 mm when connecting conductors to feedthrough terminal block. Featuring two conductor terminals along with CAGE CLAMP®, this connector delivers reliable performance. Our CAGE CLAMP® connection offers a dependable and maintenance-free way to connect all types of conductors. You do not need to prepare the conductor in any way, such as crimping ferrules. The dimensions are (7 x 23.55 x 42.5) mm (width x height x depth). Feedthrough terminal block is suitable for conductor cross sections ranging from 0.08 mm<sup>2</sup> to 4 mm<sup>2</sup>.

The contact surface is coated with tin.

## Notes

Variants:

Other pole numbers

Other colors

Direct marking

Other versions (or variants) can be requested from WAGO Sales or configured at <https://configurator.wago.com/>.

## Electrical data

Ratings per	IEC/EN 60664-1		
Overvoltage category	III	III	II
Pollution degree	3	2	2
Nominal voltage	320 V	320 V	630 V
Rated impulse withstand voltage	4 kV	4 kV	4 kV
Rated current	32 A	32 A	32 A

## Ratings per IEC/EN – Notes

Ratings (note)

Suitable for neutral-grounded, three-phase, 4-wire systems rated at 400 V (conductor-to-conductor) per IEC/EN 60664-1.

Approvals per	UL 1059		
Use group	B	C	D
Rated voltage	300 V	150 V	300 V
Rated current	20 A	20 A	10 A

Approvals per	CSA		
Use group	B	C	D
Rated voltage	300 V	150 V	300 V
Rated current	20 A	20 A	10 A

### Connection Data

Clamping units	2
Total number of potentials	1
Number of connection types	2
Number of levels	1

### Connection 1

Connection technology	CAGE CLAMP®
Actuation type	Operating tool
Solid conductor	0.08 ... 4 mm <sup>2</sup> / 28 ... 12 AWG
Fine-stranded conductor	0.08 ... 4 mm <sup>2</sup> / 28 ... 12 AWG
Fine-stranded conductor; with insulated ferrule	0.25 ... 2.5 mm <sup>2</sup>
Fine-stranded conductor; with uninsulated ferrule	0.25 ... 2.5 mm <sup>2</sup>
Strip length	9 ... 10 mm / 0.35 ... 0.39 inches
Pole number	1

### Physical data

Pin spacing	7 mm / 0.276 inches
Width	7 mm / 0.276 inches
Height	23.55 mm / 0.927 inches
Depth	42.5 mm / 1.673 inches

### Mechanical data

Housing sheet thickness	1 ... 4 mm / 0.039 ... 0.157 inches
Mounting type	Locking claw
Mounting type	Feed-through mounting
Suitable for through-panel applications	Yes

### Material data

Note (material data)	<a href="#">Information on material specifications can be found here</a>
Color	blue
Material group	I
Insulation material (main housing)	Polyamide (PA66)
Flammability class per UL94	V0
Clamping spring material	Chrome-nickel spring steel (CrNi)
Contact material	Electrolytic copper (E <sub>Cu</sub> )
Contact Plating	Tin
Fire load	0.152 MJ
Weight	6 g

### Environmental requirements

Limit temperature range	-60 ... +105 °C
Processing temperature	-35 ... +60 °C

**Commercial data**

Product Group	4 (Printed Circuit Connectors)
PU (SPU)	50 pcs
Packaging type	Box
Country of origin	DE
GTIN	4044918532112
Customs tariff number	85369010000

**Product Classification**

UNSPSC	39121410
eCl@ss 10.0	27-14-11-06
eCl@ss 9.0	27-14-11-06
ETIM 9.0	EC001284
ETIM 10.0	EC001284
ECCN	NO US CLASSIFICATION

**Environmental Product Compliance**

RoHS Compliance Status	Compliant, No Exemption
------------------------	-------------------------

**Approvals / Certificates**

**General approvals** **Declarations of conformity and manufacturer's declarations**



Approval	Standard	Certificate Name
CCA DEKRA Certification B.V.	-	2160584.32
CCA DEKRA Certification B.V.	-	NTR NL-7136
UL UL International Germany GmbH	UL 1059	E45172

Approval	Standard	Certificate Name
EU-Declaration of Conformity WAGO GmbH & Co. KG	-	-
UK-Declaration of Conformity WAGO GmbH & Co. KG	-	-

**Approvals for marine applications**



Approval	Standard	Certificate Name
ABS American Bureau of Shipping	EN 60947	24-0152298-PDA
DNV GL Det Norske Veritas, Germanischer Lloyd	-	TAE00001V2
PRS Polski Rejestr Statków	-	TE/1094/880590/23

**Downloads**

**Environmental Product Compliance**

Compliance Search			
Environmental Product Compliance			↓
826-161/000-006			

**Documentation**

Additional Information			
Technical Section	03.04.2019	pdf 2027.26 KB	↓

**CAD/CAE-Data**

CAD data	
2D/3D Models	↓
826-161/000-006	

CAE data	
EPLAN Data Portal	↓
826-161/000-006	

















ZUKEN Portal	↓
826-161/000-006	

**1 Compatible Products**

**1.1 Optional Accessories**

**1.1.1 Ferrule**

**1.1.1.1 Ferrule**

 <p><b>Item No.: 216-241</b> Ferrule; Sleeve for 0.5 mm<sup>2</sup> / 20 AWG; insulated; electro-tin plated; electrolytic copper; gastight crimped; acc. to DIN 46228, Part 4/09.90; white</p>	 <p><b>Item No.: 216-141</b> Ferrule; Sleeve for 0.5 mm<sup>2</sup> / 20 AWG; un-insulated; electro-tin plated; electrolytic copper; gastight crimped; acc. to DIN 46228, Part 1/08.92</p>	 <p><b>Item No.: 216-242</b> Ferrule; Sleeve for 0.75 mm<sup>2</sup> / 18 AWG; insulated; electro-tin plated; electrolytic copper; gastight crimped; acc. to DIN 46228, Part 4/09.90; gray</p>	 <p><b>Item No.: 216-262</b> Ferrule; Sleeve for 0.75 mm<sup>2</sup> / 18 AWG; un-insulated; electro-tin plated; electrolytic copper; gastight crimped; acc. to DIN 46228, Part 4/09.90; gray</p>
 <p><b>Item No.: 216-142</b> Ferrule; Sleeve for 0.75 mm<sup>2</sup> / 18 AWG; un-insulated; electro-tin plated; electrolytic copper; gastight crimped; acc. to DIN 46228, Part 1/08.92</p>	 <p><b>Item No.: 216-243</b> Ferrule; Sleeve for 1 mm<sup>2</sup> / AWG 18; insulated; electro-tin plated; electrolytic copper; gastight crimped; acc. to DIN 46228, Part 4/09.90; red</p>	 <p><b>Item No.: 216-263</b> Ferrule; Sleeve for 1 mm<sup>2</sup> / AWG 18; un-insulated; electro-tin plated; electrolytic copper; gastight crimped; acc. to DIN 46228, Part 4/09.90; red</p>	 <p><b>Item No.: 216-143</b> Ferrule; Sleeve for 1 mm<sup>2</sup> / AWG 18; un-insulated; electro-tin plated; electrolytic copper; gastight crimped; acc. to DIN 46228, Part 1/08.92</p>
 <p><b>Item No.: 216-244</b> Ferrule; Sleeve for 1.5 mm<sup>2</sup> / AWG 16; un-insulated; electro-tin plated; electrolytic copper; gastight crimped; acc. to DIN 46228, Part 4/09.90; black</p>	 <p><b>Item No.: 216-264</b> Ferrule; Sleeve for 1.5 mm<sup>2</sup> / AWG 16; un-insulated; electro-tin plated; electrolytic copper; gastight crimped; acc. to DIN 46228, Part 4/09.90; black</p>	 <p><b>Item No.: 216-284</b> Ferrule; Sleeve for 1.5 mm<sup>2</sup> / AWG 16; un-insulated; electro-tin plated; electrolytic copper; gastight crimped; acc. to DIN 46228, Part 4/09.90; black</p>	 <p><b>Item No.: 216-144</b> Ferrule; Sleeve for 1.5 mm<sup>2</sup> / AWG 16; un-insulated; electro-tin plated; electrolytic copper; gastight crimped; acc. to DIN 46228, Part 1/08.92; silver-colored</p>
 <p><b>Item No.: 216-246</b> Ferrule; Sleeve for 2.5 mm<sup>2</sup> / AWG 14; un-insulated; electro-tin plated; electrolytic copper; gastight crimped; acc. to DIN 46228, Part 4/09.90; blue</p>	 <p><b>Item No.: 216-266</b> Ferrule; Sleeve for 2.5 mm<sup>2</sup> / AWG 14; un-insulated; electro-tin plated; electrolytic copper; gastight crimped; acc. to DIN 46228, Part 4/09.90; blue</p>	 <p><b>Item No.: 216-286</b> Ferrule; Sleeve for 2.5 mm<sup>2</sup> / AWG 14; un-insulated; electro-tin plated; electrolytic copper; gastight crimped; acc. to DIN 46228, Part 4/09.90; blue</p>	 <p><b>Item No.: 216-106</b> Ferrule; Sleeve for 2.5 mm<sup>2</sup> / AWG 14; un-insulated; electro-tin plated; silver-colored</p>

## 1.1.2 Marking

### 1.1.2.1 Marking strip



**Item No.: 210-332/700-103**

Marking strips; as a DIN A4 sheet; MARKED; 1-12 (160x); Height of marker strip: 3 mm; Strip length 182 mm; Horizontal marking; Self-adhesive; white



**Item No.: 210-332/700-102**

Marking strips; as a DIN A4 sheet; MARKED; 12-1 (160x); Height of marker strip: 3 mm; Strip length 182 mm; Horizontal marking; Self-adhesive; white

## 1.1.3 Test and measurement

### 1.1.3.1 Testing accessories



**Item No.: 210-136**

Test plug; 2 mm Ø; with 500 mm cable; red

## 1.1.4 Tool

### 1.1.4.1 Operating tool



**Item No.: 210-720**

Operating tool; Blade: 3.5 x 0.5 mm; with a partially insulated shaft; multicoloured



**Item No.: 210-657**

Operating tool; Blade: 3.5 x 0.5 mm; with a partially insulated shaft; short; multicoloured

## Installation Notes

### Conductor termination



Inserting a conductor.

## Installation



Insert the terminal strip into the cutout until the stop hits the enclosure wall.



Secure the terminal strip to the inner side of the cutout via retaining clips.

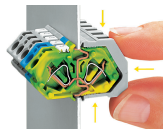

Push retaining clips until stop and press together in the direction of the terminal strip center.

## Testing



Testing with 2 mm or 2.3 mm Ø test plug.

## Marking

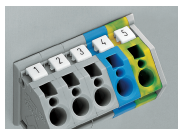

Labeling via Mini-WSB makers – directly on the terminal blocks.

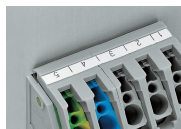

Self-adhesive marking strips adhere directly on the retaining clips.

## Application

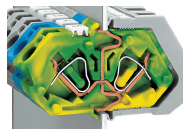

Automatic, double contact of the ground contact to the enclosure wall