

Data Sheet | Item Number: 261-202/332-000

4-conductor terminal strip; on one side with push-buttons; with fixing flanges; 2-pole; for screw or similar mounting types; Fixing hole 3.2 mm Ø; 2.5 mm²; CAGE CLAMP®; gray

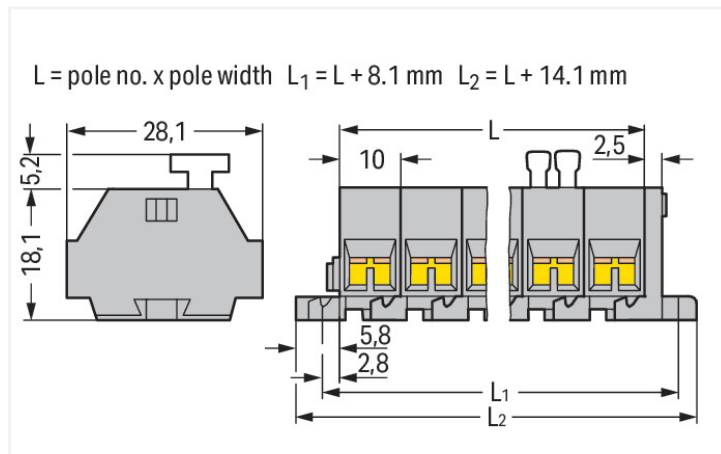

<https://www.wago.com/261-202/332-000>

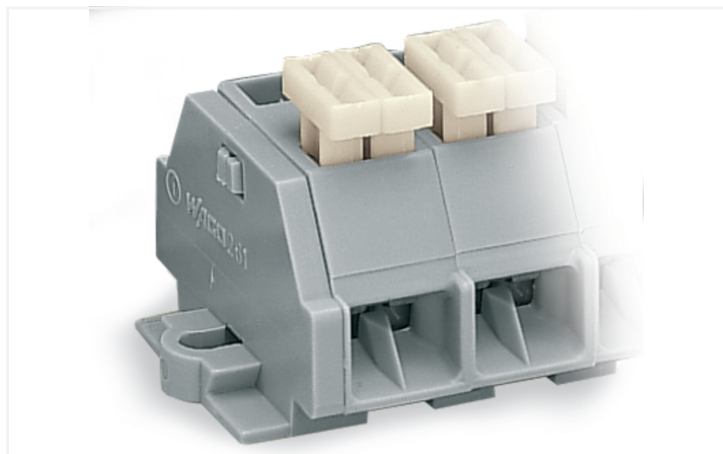

Color: ■ gray

Similar to illustration

Dimensions in mm

Through terminal block, 261 Series, CAGE CLAMP®

Our through terminal block (item number 261-202/332-000) is the perfect way to connect conductors quickly and securely. Conductors should only be connected to this through terminal block if their strip length is between 8 and 9 mm. Whether for industrial or building applications, you can use our through terminal blocks to connect electrical conductors quickly and safely. We offer variants for both classic through-wiring and potential distribution. This product features conductor terminals and utilizes CAGE CLAMP®. Our proven universal connection known as CAGE CLAMP® is the industry standard when it comes to connection technology and electrical interconnections. The dimensions are (34.1 x 28.1 x 23.3) mm (width x height x depth). Depending on the type of conductor, this through terminal block is ideal for conductor cross sections ranging from 0.08 mm² to 2.5 mm².

Operating tool, push-button is used to operate this mini rail-mount terminal block.

Electrical data

Ratings per IEC/EN

Nominal voltage (III/3)	500 V
Rated impulse withstand voltage (III / 3)	6 kV
Rated current	24 A
Legend (ratings)	(III / 3) ≙ Overvoltage category III / Pollution degree 3

Approvals per

UL 1059

Use group	B	C	D
Rated voltage	300 V	300 V	600 V
Rated current	15 A	15 A	5 A

Approvals per

CSA 22.2 No 158

Use group	B	C	D
Rated voltage	-	300 V	600 V
Rated current	-	10 A	5 A

General information

Wiring direction	Side-entry wiring
------------------	-------------------

Connection Data

Clamping units	8
Total number of potentials	2
Number of levels	1

Connection 1

Connection technology	CAGE CLAMP®
Actuation type	Operating tool
Connectable conductor materials	Copper
Solid conductor	0.08 ... 2.5 mm ² / 28 ... 14 AWG
Fine-stranded conductor	0.08 ... 2.5 mm ² / 28 ... 14 AWG
Strip length	8 ... 9 mm / 0.31 ... 0.35 inches
Pole number	2
Wiring direction	Side-entry wiring

Connection 2

Actuation type	Push-button
----------------	-------------

Physical data

Width	34.1 mm / 1.343 inches
Height	28.1 mm / 1.106 inches
Depth	23.3 mm / 0.917 inches
Module width	10 mm / 0.394 inches

Mechanical data

Design	horizontal type
Mounting type	Mounting flange
Marking level	Side marking

Material data

Note (material data)	Information on material specifications can be found here
Color	gray
Material group	I
Insulation material (main housing)	Polyamide (PA66)
Flammability class per UL94	V0
Fire load	0.199 MJ
Halogen-free	Yes
Weight	9.4 g

Commercial data

PU (SPU)	100 pcs
Packaging type	Box
Country of origin	DE
GTIN	4044918612524
Customs tariff number	85369010000

Product Classification

UNSPSC	39121410
eCl@ss 10.0	27-14-11-06
eCl@ss 9.0	27-14-11-06
ETIM 9.0	EC001284
ETIM 10.0	EC001284
ECCN	NO US CLASSIFICATION

Environmental Product Compliance

RoHS Compliance Status	Compliant, No Exemption
------------------------	-------------------------

Approvals / Certificates

General approvals **Declarations of conformity and manufacturer's declarations**



Approval	Standard	Certificate Name
CCA DEKRA Certification B.V.	EN 60998	NTR-NL 6509
KEMA/KEUR DEKRA Certification B.V.	EN 60998	2110272.02

Approval	Standard	Certificate Name
EU-Declaration of Conformity WAGO GmbH & Co. KG	-	-
UK-Declaration of Conformity WAGO GmbH & Co. KG	-	-

Approvals for marine applications



Approval	Standard	Certificate Name
ABS American Bureau of Shipping	-	24-0095979-PDA

Downloads

Environmental Product Compliance

Compliance Search	
Environmental Product Compliance 261-202/332-000	↓

Documentation

Bid Text			
261-202/332-000	19.02.2019	xml 3.15 KB	↓
261-202/332-000	16.08.2017	doc 25.00 KB	↓

CAD/CAE-Data

CAD data

2D/3D Models
261-202/332-000 

CAE data

EPLAN Data Portal
261-202/332-000 

WSCAD Universe
261-202/332-000 

ZUKEN Portal
261-202/332-000 

1 Compatible Products

1.1 Optional Accessories

1.1.1 Ferrule

1.1.1.1 Ferrule



Item No.: 216-301
Ferrule; Sleeve for 0.25 mm² / AWG 24; insulated; electro-tin plated; yellow



Item No.: 216-302
Ferrule; Sleeve for 0.34 mm² / 22 AWG; insulated; electro-tin plated; light turquoise



Item No.: 216-201
Ferrule; Sleeve for 0.5 mm² / 20 AWG; insulated; electro-tin plated; electrolytic copper; acc. to DIN 46228, Part 4/09.90; white



Item No.: 216-101
Ferrule; Sleeve for 0.5 mm² / AWG 22; un-insulated; electro-tin plated; silver-colored



Item No.: 216-202
Ferrule; Sleeve for 0.75 mm² / 18 AWG; insulated; electro-tin plated; gray



Item No.: 216-102
Ferrule; Sleeve for 0.75 mm² / AWG 20; un-insulated; electro-tin plated; silver-colored



Item No.: 216-203
Ferrule; Sleeve for 1 mm² / AWG 18; insulated; electro-tin plated; red



Item No.: 216-103
Ferrule; Sleeve for 1 mm² / AWG 18; un-insulated; electro-tin plated



Item No.: 216-204
Ferrule; Sleeve for 1.5 mm² / AWG 16; insulated; electro-tin plated; black



Item No.: 216-104
Ferrule; Sleeve for 1.5 mm² / AWG 16; un-insulated; electro-tin plated; silver-colored



Item No.: 216-205
Ferrule; Sleeve for 2.08 mm² / AWG 14; insulated; electro-tin plated; yellow



Item No.: 216-206
Ferrule; Sleeve for 2.5 mm² / AWG 14; insulated; electro-tin plated; blue



Item No.: 216-106
Ferrule; Sleeve for 2.5 mm² / AWG 14; un-insulated; electro-tin plated; silver-colored

1.1.2 Installation

1.1.2.1 Mounting accessories



Item No.: 209-137
Mounting adapter; can be used as end stop; 6.5 mm wide; gray



Item No.: 209-123
Mounting foot with screw; can be screwed on terminal blocks with fixing flange; 6.4 mm wide; gray

1.1.3 Jumper

1.1.3.1 Jumper



Item No.: 261-402

Jumper; for conductor entry; 2-way; insulated; gray

1.1.4 Marking

1.1.4.1 Marking strip



Item No.: 210-833

Marking strips; 25 m on roll; 6 mm wide; plain; Self-adhesive; white

1.1.5 Tool

1.1.5.1 Operating tool



Item No.: 210-658

Operating tool; Blade: 3.5 x 0.5 mm; with a partially insulated shaft; angled; short; multicoloured



Item No.: 210-720

Operating tool; Blade: 3.5 x 0.5 mm; with a partially insulated shaft; multicoloured



Item No.: 210-657

Operating tool; Blade: 3.5 x 0.5 mm; with a partially insulated shaft; short; multicoloured

Installation Notes

Conductor termination

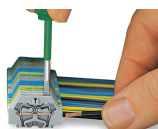

CAGE CLAMP® connection

Inserting a conductor.

With ferruled conductors, it is necessary to use a terminal block one size larger than the conductor's nominal cross-section.

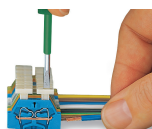

CAGE CLAMP® connection

Inserting a conductor via push-button.

Commoning

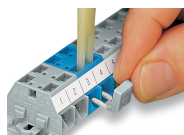

Commoning with comb-style jumper bar.

Installation

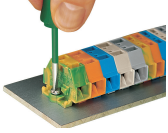

Mounting and securing a terminal strip directly to the plate via screw-type flanges.

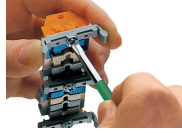

Terminal strip with mounting flanges
Screwing a mounting foot (209-123).
(Distance between mounting feet: approx. 25 ... 30 mm)

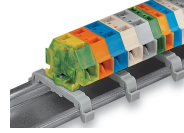

Terminal strip; with mounting flanges; for DIN-35 rail



Terminal strip with mounting flanges, for screw or similar mounting types, 3.2 mm mounting hole diameter (with 209-123 Mounting Foot also for DIN-35 rail)

Marking



Marking with self-adhesive marking strips.



Marking by direct printing (upon request).