

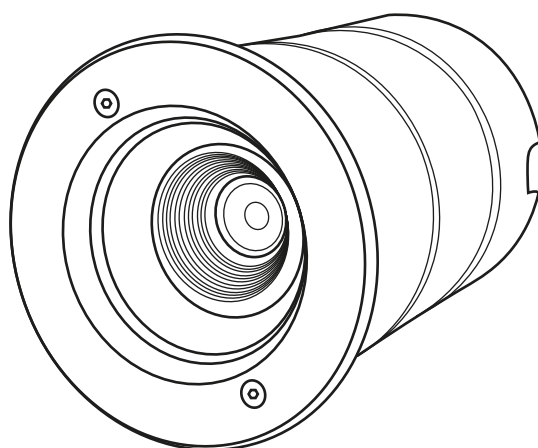

Read these instructions & save for future use

Ground spot | 230V | 123mm | 23 watt | 3000K | adj. | dim



Article number **140-089**

Brand **Tronix Lighting**

Type **Ground spots**

Contents of this product **1x ground spot 23W 3000K**

Technical datasheet **Digitally available
on our webshop**



*View instructions and
technical data also on
our website*

TRONIX



Before first use

Before getting started with this product, it is advisable to check the order completeness and any damage. If this is the case, please contact Tronix Lighting.

Description

This 230V ground spotlight is perfect for "heavy duty" applications. The sturdy, long connecting cable has a PU H07BQ-F jacket. This keeps the spot (and connection) protected against wear and tear, chemicals and low temperatures. In short: A ground spot that stands its ground, regardless of the location.

Features

- Tiltable beam up to 22°;
- High quality connection cable (3m) PU, H07BQ-F 3x1mm²;
- IK10 impact resistant for 'heavy duty' applications and IP67 certified;
- Equipped with anti-condensation gland for effective pressure equalization between the inside and outside of the housing.

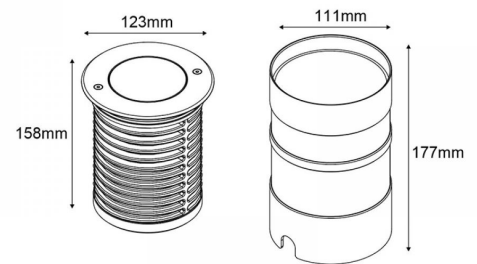

Installation

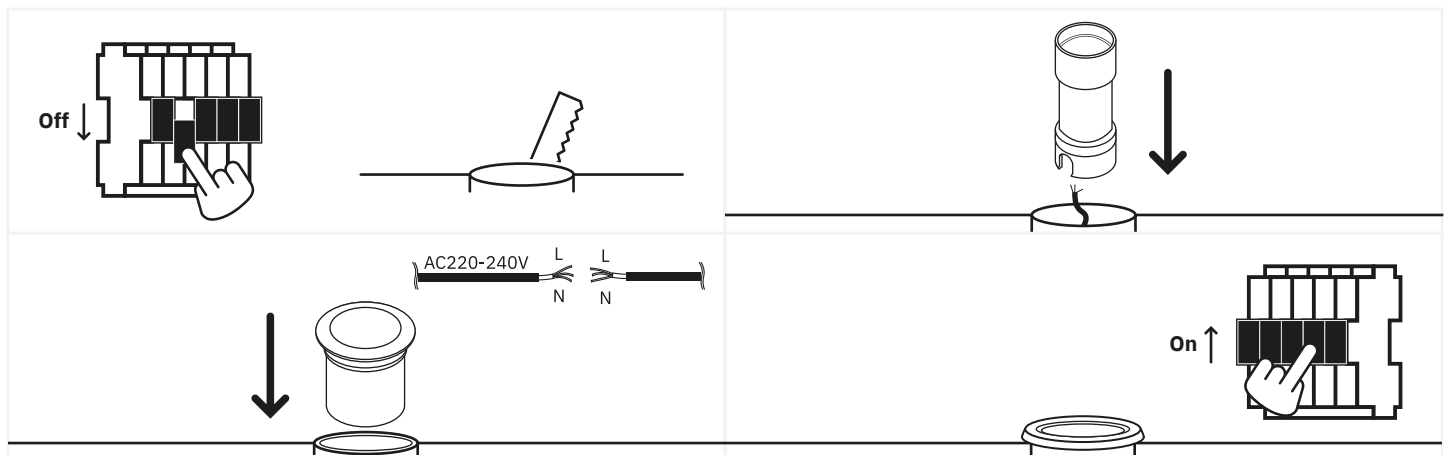

1. Turn off the power, remove the product and accompanying parts from the packaging. Then cut a hole to size to insert the ground spotlight later;
2. Check the wiring and then put it through the outer sleeve of the ground spotlight;
3. Connect the cables and place the spotlight itself in the sleeve and secure it where necessary;
4. Check the complete installation after the ground spotlight is installed. Should it be in order, the mains power can be reactivated.



Safety

Safety is a top priority at Tronix Lighting. Therefore, we heartily recommend that you follow the following steps closely:

- Keep this manual carefully for future reference;
- Choose a qualified electrician while installing, maintaining or inspecting this product;
- Never look directly into a light source to avoid possible damage to the eye;
- Always ensure that the relevant power group is on non-active when the product is connected;
- Use only recommended combinations (LED drivers, controllers or dimmers) to avoid injury or damage to the product.

Technical problems and repair

Should a product not work properly after installation, or if the product exhibits problems over time, it is advisable to check the following elements:

- Check the wiring and installation of your product;
- Check for the presence of interfering elements such as dust, water or other electronics;
- If possible, try disconnecting the product and testing it in another location to rule out a problem at the location;
- Should you be dealing with a WIFI-based product, check and reset your router's settings.

Should the product still not work after testing, it is recommended to send it in for inspection and/or repair. To do so, please contact Tronix Lighting using nearby details and proof of purchase (packing slip).



CARE



SHARE



CONNECT

Supplier:

Tronix Lighting B.V

Vluchtoord 41
5406 XP Uden, Netherlands

+31 (0)413 330 380
sales@tronixlighting.com

Terms and symbols (as relevant to product)



The **CE mark** indicates that this product complies with EU regulations on safety, health and environmental protection;



The **WEEE symbol** stands for "Waste Electrical and Electronic Equipment Regulation," a directive on the collection, recycling and recovery of electronic waste;



The **Class I symbol** indicates that this product is protected by means of the additional ground cable. This cable is identified by the yellow/green jacket and is attached to this product;

- This product has an **IP67 rating**. This means that the housing is touch-safe, provides full protection against dust and can withstand immersion (30 min at 1m).