

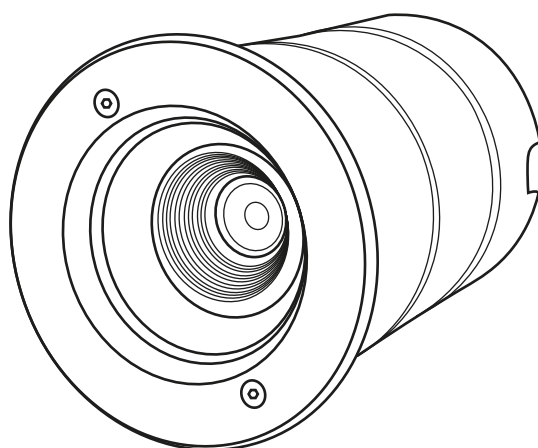

Read these instructions & save for future use

## Ground spot | 230V | 123mm | 16 watt | 2700K | adj. | dim



Article number **140-086**

Brand **Tronix Lighting**

Type **Ground spots**

Contents of this product **1x ground spot 16W 2700K**

Technical datasheet **Digitally available  
on our webshop**



*View instructions and  
technical data also on  
our website*

**TRONIX**



## Before first use

Before getting started with this product, it is advisable to check the order completeness and any damage. If this is the case, please contact Tronix Lighting.

## Description

This 230V ground spotlight is perfect for "heavy duty" applications. The sturdy, long connecting cable has a PU H07BQ-F jacket. This keeps the spot (and connection) protected against wear and tear, chemicals and low temperatures. In short: A ground spot that stands its ground, regardless of the location.

### Features

- Tiltable beam up to 22°;
- High quality connection cable (3m) PU, H07BQ-F 3x1mm<sup>2</sup>;
- IK10 impact resistant for 'heavy duty' applications and IP67 certified;
- Equipped with anti-condensation gland for effective pressure equalization between the inside and outside of the housing.

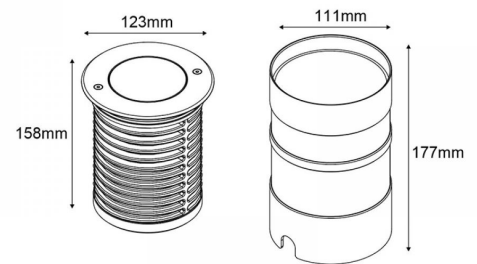

## Installation

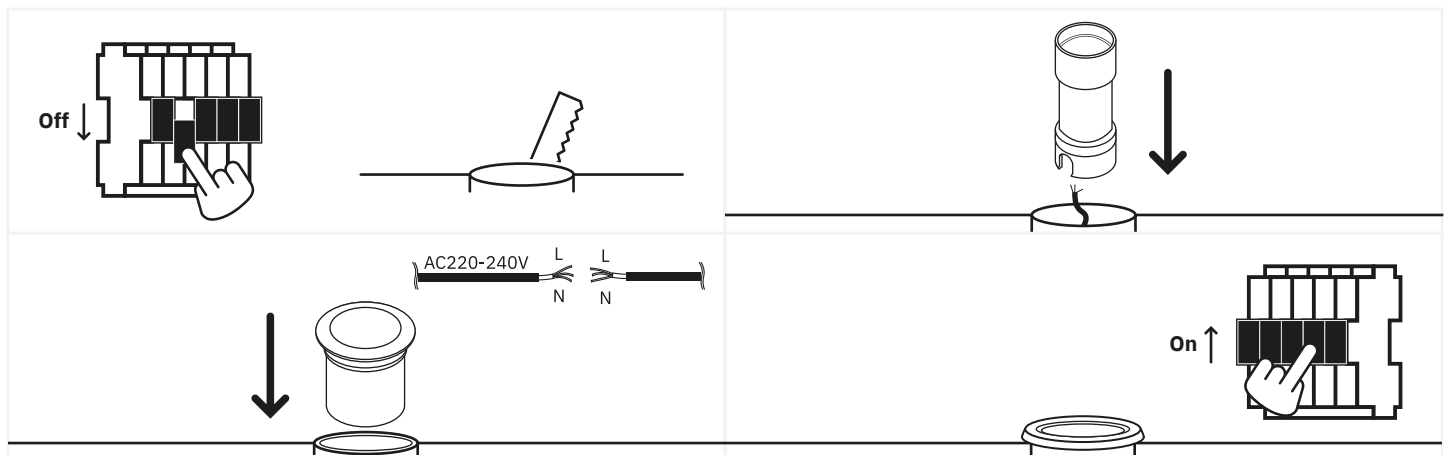

1. Turn off the power, remove the product and accompanying parts from the packaging. Then cut a hole to size to insert the ground spotlight later;
2. Check the wiring and then put it through the outer sleeve of the ground spotlight;
3. Connect the cables and place the spotlight itself in the sleeve and secure it where necessary;
4. Check the complete installation after the ground spotlight is installed. Should it be in order, the mains power can be reactivated.



## Safety

Safety is a top priority at Tronix Lighting. Therefore, we heartily recommend that you follow the following steps closely:

- Keep this manual carefully for future reference;
- Choose a qualified electrician while installing, maintaining or inspecting this product;
- Never look directly into a light source to avoid possible damage to the eye;
- Always ensure that the relevant power group is on non-active when the product is connected;
- Use only recommended combinations (LED drivers, controllers or dimmers) to avoid injury or damage to the product.

## Technical problems and repair

Should a product not work properly after installation, or if the product exhibits problems over time, it is advisable to check the following elements:

- Check the wiring and installation of your product;
- Check for the presence of interfering elements such as dust, water or other electronics;
- If possible, try disconnecting the product and testing it in another location to rule out a problem at the location;
- Should you be dealing with a WIFI-based product, check and reset your router's settings.

Should the product still not work after testing, it is recommended to send it in for inspection and/or repair. To do so, please contact Tronix Lighting using nearby details and proof of purchase (packing slip).



CARE



SHARE



CONNECT

### Supplier:

Tronix Lighting B.V

Vluchtoord 41  
5406 XP Uden, Netherlands

+31 (0)413 330 380  
sales@tronixlighting.com

## Terms and symbols (as relevant to product)



The **CE mark** indicates that this product complies with EU regulations on safety, health and environmental protection;



The **WEEE symbol** stands for "Waste Electrical and Electronic Equipment Regulation," a directive on the collection, recycling and recovery of electronic waste;



The **Class I symbol** indicates that this product is protected by means of the additional ground cable. This cable is identified by the yellow/green jacket and is attached to this product;

- This product has an **IP67 rating**. This means that the housing is touch-safe, provides full protection against dust and can withstand immersion (30 min at 1m).