

## Walraven RapidRail® Connector 90° (L/L)

(G3508)

to make Walraven RapidRail® fabrications

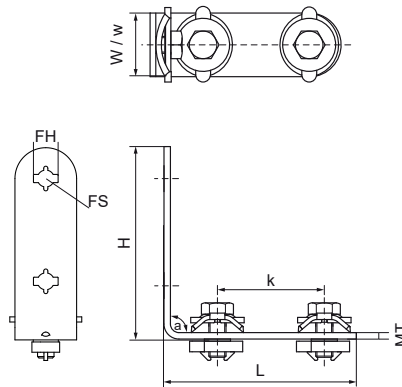

### Features & benefits

- connector with pre-assembled Walraven RapidRail® Slide nut(s)
- to make rail fabrications
- suitable for rails 27x18, 30x15, 30x20, 30x30, 30x45, 38x40
- ready-to-use pre-assembled for a quick fixing, and retains assembly in place before final tightening
- material: metal parts made of steel 1.0332; spring(s) made of POM (polyoxymethylene), green
- zinc plated
- For detailed technical information about our RAL marked products, please see the RAL datasheet in our web catalogue.



Product Number	VVS Number	For Rail Type	Angle	Total Height	Total Width	Total Length	Material Thickness	Width	Fixing Hole	Fixing Slot	Heart To Heart Distance	Torque Moment For Installation	Maximum Allowed Load Faz	Maximum Allowed Load Fax
Reference letter			<i>a</i>	<i>H</i>	<i>W</i>	<i>L</i>	<i>MT</i>	<i>w</i>	<i>FH</i>	<i>FS</i>	<i>k</i>	<i>T inst.</i>	<i>Fa,z</i>	<i>Fa,x</i>
Unit description			°	mm	mm	mm	mm	mm	mm	mm	mm	Nm	N	N
6584011	018042340	27x18, 30x15, 30x20, 30x30, 30x45, 38x40	90	103.5	30	93.5	3.00	30	8.2	12x4	50	15	1,562	720