



User Manual

for S6 Series Hybrid Inverter



Applicable models

S6-EH3P8K02-NV-YD-L
S6-EH3P10K02-NV-YD-L
S6-EH3P12K02-NV-YD-L
S6-EH3P15K02-NV-YD-L
S6-EH3P18K02-NV-YD-L
S6-EH3P7K02-LV-YD-L
S6-EH3P8K02-LV-YD-L
S6-EH3P9K02-LV-YD-L
S6-EH3P10K02-LV-YD-L

Applicable System

Three phase system

Important Notes

- Due to the product development, the product specifications and functions are subject to change. The latest manual can be acquired via <https://www.ginlong.com/global>. Every attempt has been made to make this document complete, accurate and up-to-date. Individuals reviewing this document and installers or service personnel are cautioned, however, that Solis reserves the right to make changes without notice and shall not be responsible for any damages, including indirect, incidental or consequential damages caused by reliance on the material presented including, but not limited to, omissions, typographical errors, arithmetical errors or listing errors in the material provided in this document.
- Solis accepts no liability for customers' failure to comply with the instructions for correct installation and will not be held responsible for upstream or downstream systems Solis equipment has supplied.
- The customer is fully liable for any modifications made to the system; therefore, any hardware or software modification, manipulation, or alteration not expressly approved by the manufacturer shall result in the immediate cancellation of the warranty.
- Given the countless possible system configurations and installation environments, it is essential to verify adherence to the following:
 - There is sufficient space suitable for housing the equipment.
 - Airborne noise produced depending on the environment.
 - Potential flammability hazards.
 - Solis will not be held liable for defects or malfunctions arising from:
 - Improper use of the equipment.
 - Deterioration resulting from transportation or particular environmental conditions.
 - Performing maintenance incorrectly or not at all.
 - Tampering or unsafe repairs.
 - Use or installation by unqualified persons.
 - This product contains lethal voltages and should be installed by qualified electrical or service personnel having experience with lethal voltages.

Contents

1. Introduction	01
1.1 Product Overview	01
1.2 Inverter Wire Box and Connection Points	02
1.3 Packaging	03
1.4 Tools Required for Installation	04
1.5 System Description	05
2. Safety & Warning	12
2.1 Safety	12
2.2 General Safety Instructions	12
2.3 Notice for Use	14
2.4 Notice for Disposal	14
3. Installation	15
3.1 Select a Location to Install the Inverter	15
3.2 Product Handling	17
3.3 Mounting the Inverter	18
3.4 Inverter Wiring Overview	20
3.5 Ground Cable Installation	21
3.6 PV Cable Installation	22
3.7 Battery Cable Installation	25
3.8 AC Wiring	26
3.9 CT Connection	27
3.10 Inverter Communication	28
3.11 Inverter Remote Monitoring Connection	37
3.12 System wiring	38
4. Overview	39
4.1 Screen	39
4.2 Keypad	39
4.3 LED Indicators	39
4.4 Inverter built-in Bluetooth description	40
5. Commissioning	41
5.1 Preparation of Commissioning	41
5.2 Commissioning Procedure	41
5.3 Log in the APP via Bluetooth	42
5.4 Shutdown procedure	44
5.5 Work Mode and Settings	45
5.6 TOU Function Settings	51
5.7 Battery Settings	52

Contents

5.8 Battery Functions setting	53
5.9 Smart port settings	54
5.10 Grid port settings	57
5.11 Parallel Settings	58
5.12 Only PV power load function	58
5.13 Heat pump setting	59
5.14 Dual meters setting	60
5.15 HMI Screen Setting	61
6. Maintenance	71
6.1 Smart O&M	71
7. Troubleshooting	72
8. Specifications	77
9. Appendix - FAQs	92

1.1 Product Overview

The Solis series is designed for commercial hybrid systems.

The inverter can work with maximize self-consumption and provide backup power if the grid fails and there is not enough PV power to cover load demand.

The Solis S6 series consists of the following inverter models:

8kW, 10kW, 12kW, 15kW, 18K, 7kW-LV, 8kW-LV, 9kW-LV, 10K-LV

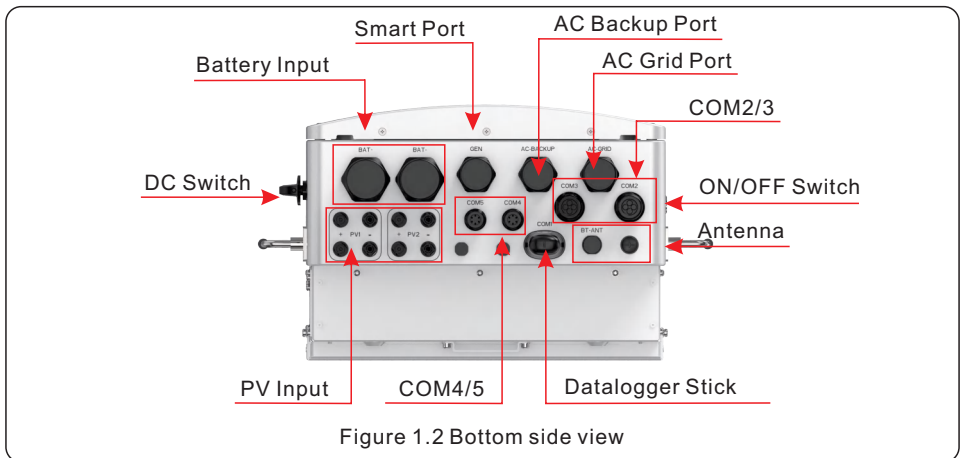
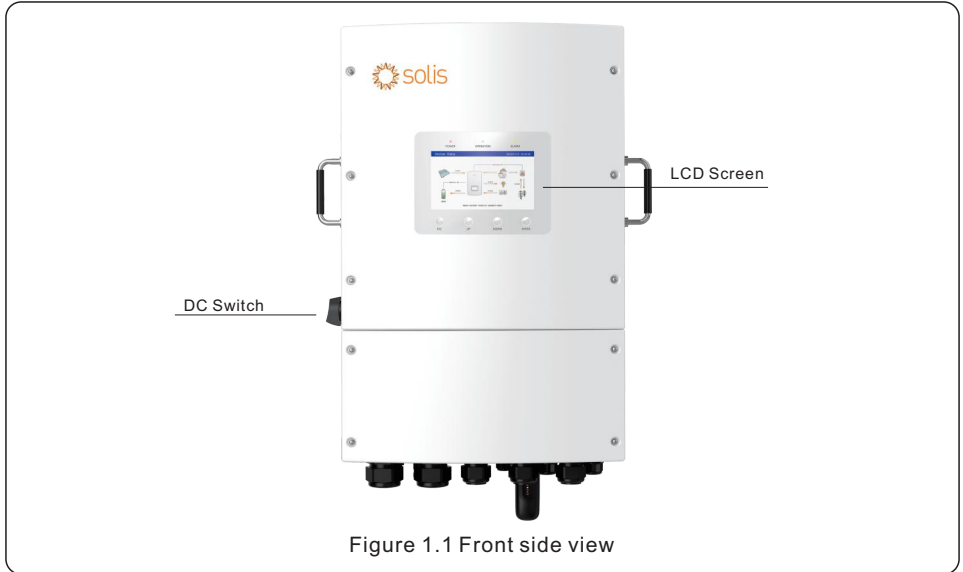

1.2 Inverter Wire Box and Connection Points

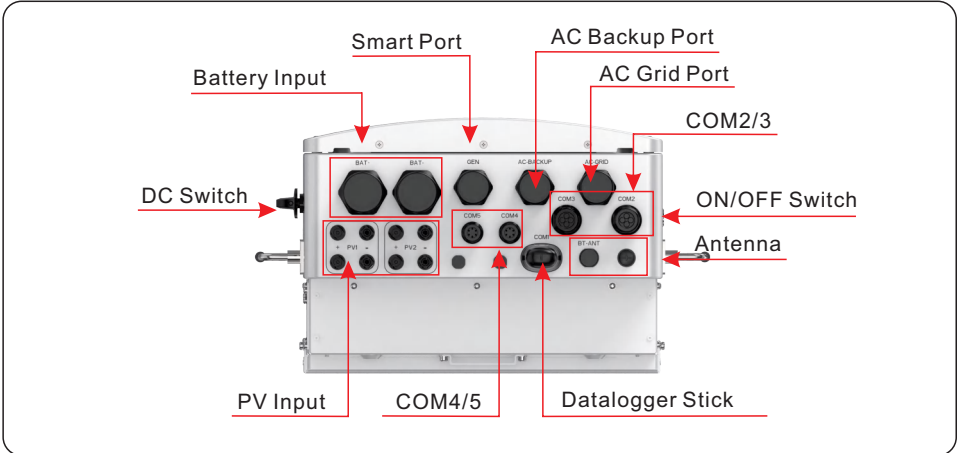

Name	Description
1. DC Switch	This is the DC disconnect switch for the PV
2. Battery Input	Conduit for Battery conductors should be connected here
3. GEN	Conduit for AC conductors to generator should be connected here
4. Backup	Conduit for AC conductors to backup loads panel should be connected here
5. Grid	Conduit for AC conductors to the main service panel should be connected here
6. PV Input	Conduit for PV conductors should be connected here
7. COM4/5	Conduit for CT conductors should be connected here
8. COM2/3	RS485 and CAN communication cables and parallel cables should go through these
9. Datalogger Stick	Solis data logger gets connected here-only USB version of the loggers will work
10. Bluetooth Antenna	Extends the range of the inverter Bluetooth signal(for system commissioning)
11. ON/OFF Switch	Turn on/off the hybrid inverter

1.3 Packaging

Please ensure that the following items are included in the packaging with your machine:

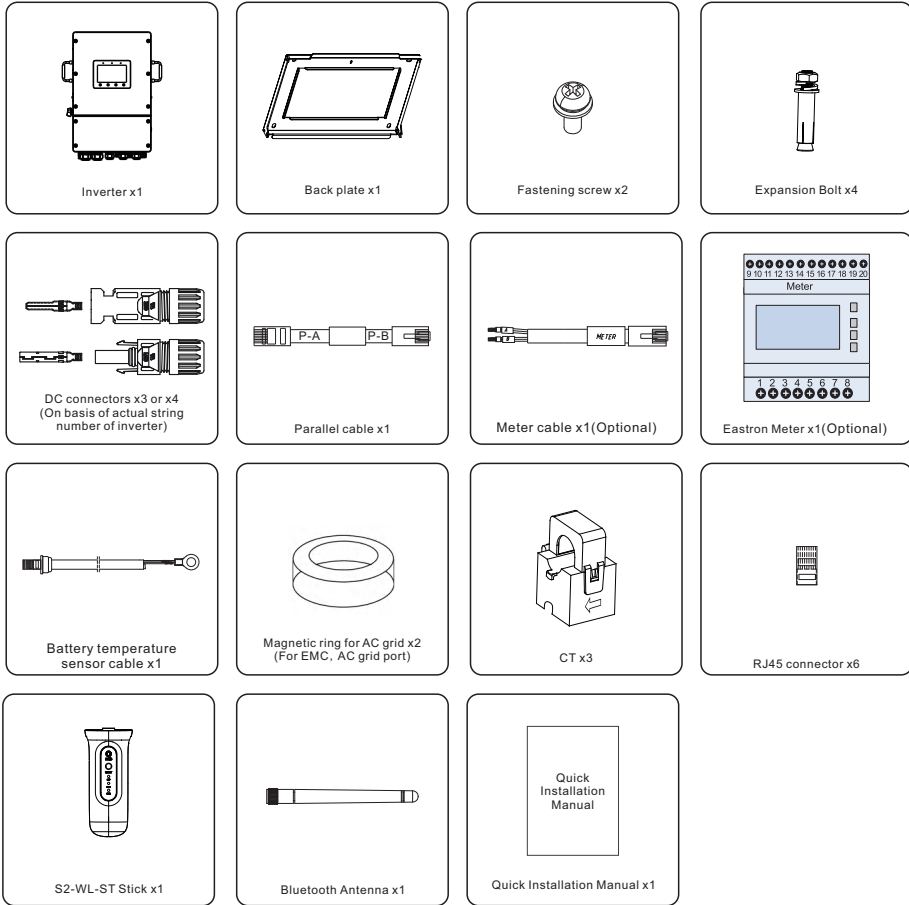

NOTE:

- If customer purchases the CT configuration scheme, the attachment only contains CT.100A/50mA CT; MODEL: ESCT-TA16-100A/50mA.
- If the meter configuration plan is purchased, the accessories include CT, the meter, and the meter communication cable. 40mA Meter+120A/40mA CT; MODEL:SDM630MCT+ESCT-TA16.
- If more than 3 devices are connected in parallel , you need select a separate kit. The accessories include CT and the meter.
Separate Kit: 5A Meter+300A/5A CT,MODEL: SDM630MCT V2+ESCT-T50

If anything is missing, please contact your local Solis distributor.

1.4 Tools Required for Installation



1.5 System Description

1.5.1 Single system

The single system consists of PV module, battery, hybrid inverter, CT or smart meter. The PV Module converts solar energy into electric energy, which is then converted by the inverter to charge the battery or power loads or feed into the grid.

User can connect heat pump, existing PV plant, generator and ATS according to the actual scenario. The backup load should be less than or equal to the rated power and the single-phase max. output power is 50% of the total AC power.

The system has three working modes: self-use mode, feed in priority mode and off-grid mode.

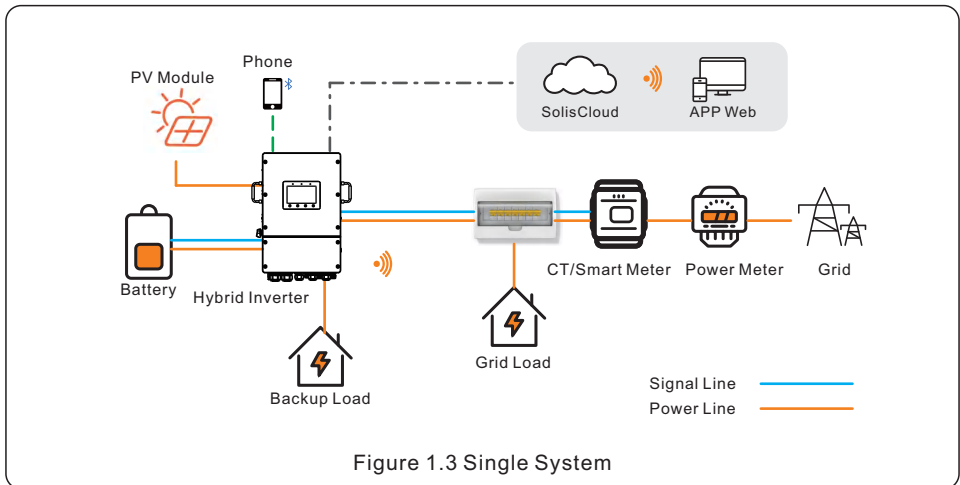

NOTE:

- If the CTs are connected, the Smart meter is not essential.
- you can choose CT scheme or Meter scheme deliver with inverter.
- In the event of a power outage on the grid, the system will seamlessly transition into off-grid mode, providing power exclusively to essential backup loads.
- When the grid recovers, the system switches back to the on-grid operation.
- Supports heat pump control, only when it has a SG Ready label.

1.5.2 Parallel System

User can add inverters and batteries to increase capacity. The system supports up to 6 inverters in parallel. Inverter Share a battery system.

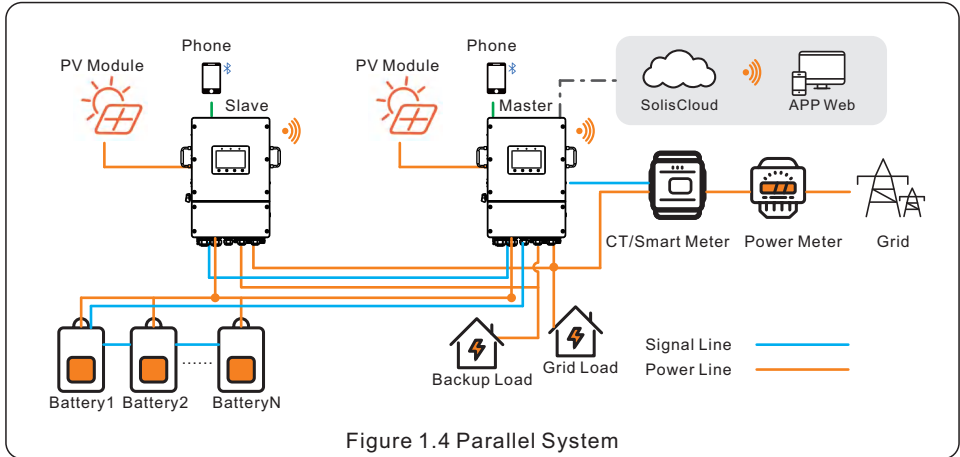

NOTE:

- In parallel-system scenarios, maximum support 6 parallel connections. Parallel connection of different models is not supported. (Like 12K and 15K can't be connected in parallel).
- The AC-Backup port can be connected in parallel, and the single-phase max. output power is 50% of the total AC power.
- In parallel-system scenarios, connecting DG via ATS is recommended; In the parallel system, each inverter is recommended to plug in the datalogger, otherwise, the remote upgrade cannot be performed.
- The parallel cable between the two inverters should not exceed 5m.
- Inverters Share a battery system, and the BMS connect to the master.



NOTE:

Single inverter noise is less than 65 dB (A), When using multiple inverters to combine, pay attention to noise protection.

1.5.3 System with generator

The access of Diesel Generator is in the off-grid scenario.

The system stores PV energy in batteries during daytime, provided that there is energy surplus and supplies power to loads when the PV energy is insufficient or there is no PV energy at night.

When the battery power drops to a certain value, and a power outage occurs in the grid, the system will start the generator to power the load and charge the battery.

Generator's work logic is as follows:

- (i) when the grid is not available and the battery is discharged to GEN_Start_SOC, the generator starts to power the load and charges the battery to GEN_Exit_SOC, then the generator stops.
- (ii) If the load power > the generator rated power in (i), the battery will be discharged to power the load until Overdischarge_SOC, then generator may shutdown due to overload and the load will be powered off.
- (iii) If the generator fail to start in (i), the battery will be discharge to Overdischarge_SOC, then the load power off.
- (iv) If the system goes into the end of (iii), the battery will not discharge before it is charged to Overdischarge_SOC+ Overdischarge_Hysteresis_SOC (set by user).

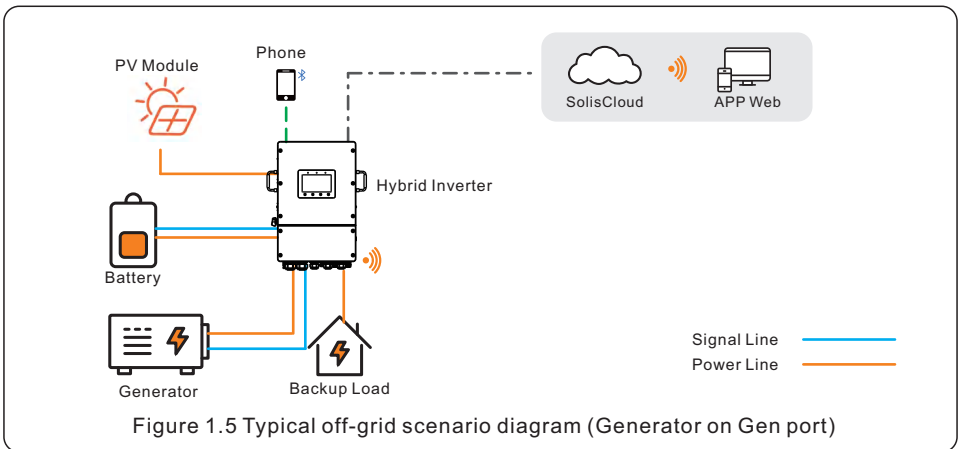

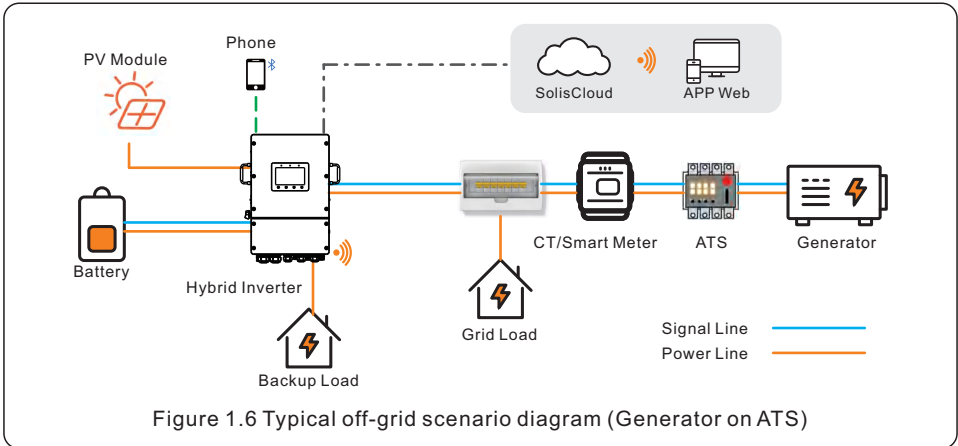

Figure 1.6 Typical off-grid scenario diagram (Generator on ATS)



NOTE:

- In single system, a diesel generator can be connected via both AC-Gen port and ATS. If via AC-Gen port, it will only supply power to the backup load ; if it is necessary to supply power to the grid side, it is recommended that the generator be connected through ATS.
- In parallel-system scenarios, connecting a diesel generator via ATS is recommended.
- When the system is connected to the generator, it cannot be connected to a grid-tied inverter, because of a risk of damaging the generator.
- When the generator connect to the gen port, gen power should be less than or equal to the rate power, only support three phase generator.
- If the generator is connected through an ATS on the grid side, then CT or smart meter is required.



CAUTION:

When the generator is connected, it is essential to correctly select the generator position on the APP, otherwise it may cause system failure or damage to the generator.

1.5.4 System with grid-tied inverter

Generally, the access of grid-tied inverter is for the retrofit of a existing PV plant. The S6 hybrid inverter support access of both Solis grid-tied inverter and third-party grid-tied inverter.

1.5.4.1 Access of third-party grid-tied inverter(Smart port)

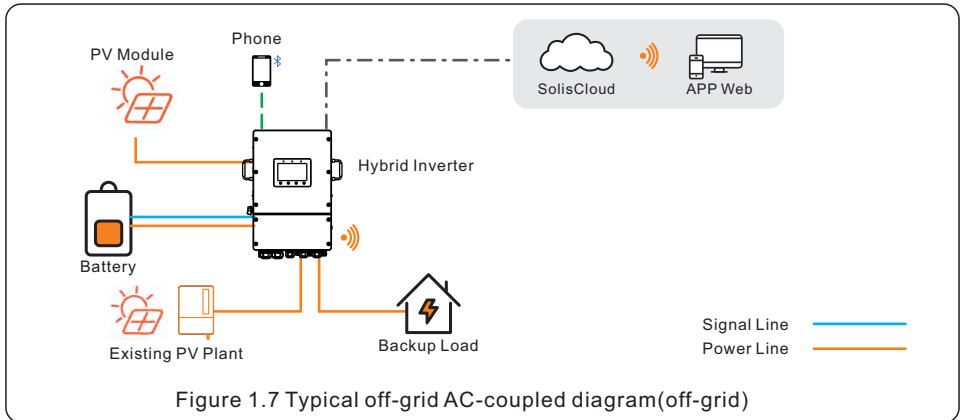

Figure 1.7 Typical off-grid AC-coupled diagram(off-grid)

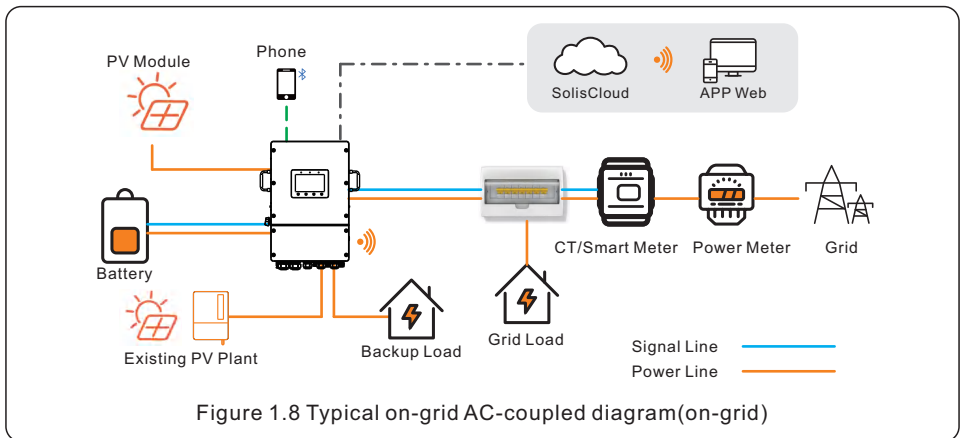

Figure 1.8 Typical on-grid AC-coupled diagram(on-grid)

- Third-party grid-tied inverter can be connected via AC-Gen port.
- With third-party grid-tied inverter connected to the gen port, it should be: Grid-tied inverter power \leq rated AC power of S6 inverter. Only support three phase grid-tied inverter.
- In on-grid scenario, when the third-party grid-tied inverter is connected, the system cannot control the output power of the third-party grid-tied inverter, if you want the 0 export, you can turn on the Max Export Control(Smart port setting, AC couple setting, Based on Export Power&SOC), it will turn off the smart port relay when export.
- In off-grid scenario, the third-party grid-tied inverter must be configured with the correct grid code and equipped with over-frequency load shedding and under-frequency load rising functionalities. These features allow the system to dynamically adjust the frequency, effectively controlling the output power of the grid-tied inverter.

1.5.4.2 Access of third-party grid-tied inverter(Grid side)

Working with grid-tied inverter and monitor the grid-tied inverter output via meter.

The output power of the grid-tied inverter can be displayed on soliscloud use the same meters in parallel. Meter1 address: 001 (grid side), meter2 address: 002 (PV inverter).

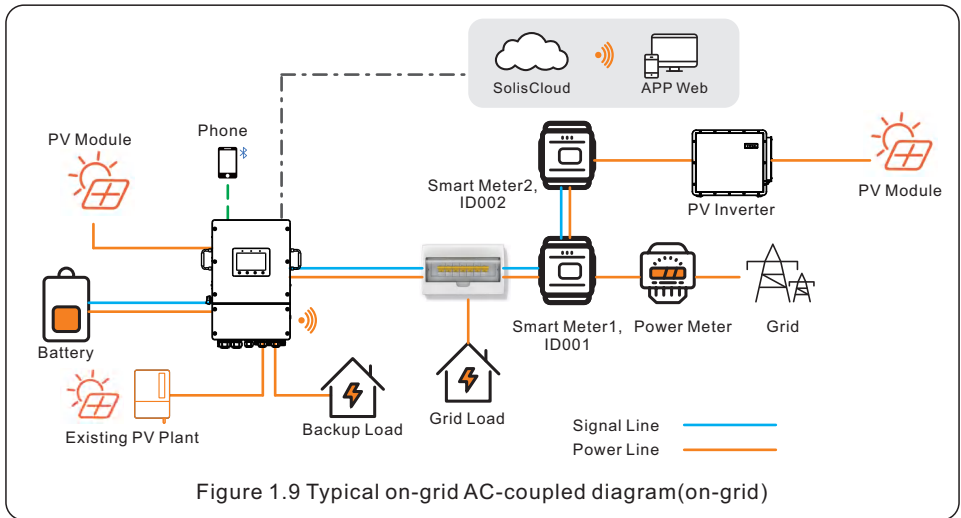

1.5.5 System with Smartload

The Gen port has extended power, which can be used as Smart load output.

You can use the smartload function to connect critical loads to the backup port and non-critical loads to the Gen port. This allows you to manage the power supply of different loads when off-grid. The backup load + smart load less than or equal to the rated power.

When the battery SOC/Volt reach the ON set value, the smart port will supply power to the load. When the battery SOC/Volt drops to OFF SOC/Volt, it will cut off the power of the load.

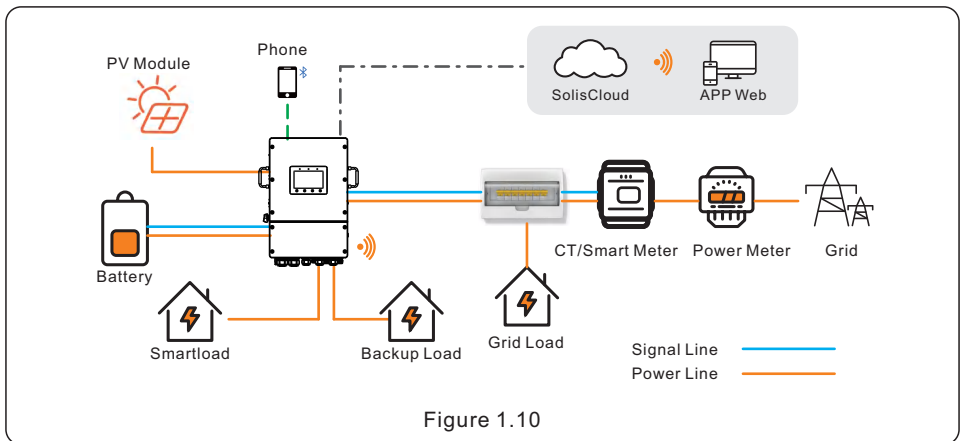

2.1 Safety

The following types of safety instructions and general information appear in this document as described below:



DANGER

“Danger” indicates a hazardous situation which if not avoided, will result in death or serious injury.



WARNING

“Warning” indicates a hazardous situation which if not avoided, could result in death or serious injury.



CAUTION

“Caution” indicates a hazardous situation which if not avoided, could result in minor or moderate injury.



NOTE

“Note” provides tips that are valuable for the optimal operation of your product.



WARNING: Risk of fire

Despite careful construction, electrical devices can cause fires.

- Do not install the inverter in an area containing flammable materials or gases.
- Do not install the inverter in a potentially explosive atmosphere.

2.2 General Safety Instructions



WARNING

Only devices in compliance with SELV (EN 69050) may be connected to the RS485 and USB interfaces.



WARNING

Do not connect PV array positive (+) or negative (-) to ground, doing so could cause serious damage to the inverter.



WARNING

Electrical installations must be done in accordance with local and national electrical safety standards.



WARNING

Do not touch any internal parts until 5 minutes after disconnection from the utility grid, PV array, and battery.



WARNING

To reduce the risk of fire, over-current protective devices (OCPD) are required for all circuits connected to the inverter.

The DC OCPD shall be installed per local requirements. All photovoltaic source and output circuit conductors shall have isolators that comply with the NEC Article 690, Part II.

All Solis single phase inverters feature an integrated DC disconnect switch.



CAUTION

Risk of electric shock, do not remove the cover. There are no serviceable parts inside, refer servicing to qualified and accredited service technicians.



CAUTION

The PV conductors are energized with high voltage DC when the PV modules are exposed to sunlight.



CAUTION

The surface temperature of the inverter can reach up to 75°C.

To avoid risk of burns, do not touch the surface of the inverter while it is operating. The inverter must be installed out of direct sunlight exposure.



NOTE

PV modules used with inverter must have an IEC 61730 Class A rating.



WARNING

Operations must be accomplished by a licensed electrician or a person authorized by Solis.



WARNING

Installer must wear personal protective equipment during the entire installation process in case of electrical hazards.



WARNING

The AC Backup Port of the inverter cannot be connected to the grid.



WARNING

Please refer to the product manual of the battery before installation and configuration to the inverter.



Systems using this product shall be designed and built in accordance with the NEC & local electrical codes & standards.

2.3 Notice for Use

The inverter has been constructed according to the applicable safety and technical guidelines, use the inverter in installations that meet the following specifications only:

1. Permanent installation is required.
2. The electrical installation must be compliant with all local and national regulations & standards.
3. The inverter must be installed according to the instructions stated in this manual.
4. The inverter must be installed according to the inverter technical specifications.
5. The inverter contains an internal NEB that meets the requirements of NRS 097-2-1:2024 Section 5.4.

2.4 Notice for Disposal

This product shall not be disposed as household waste.

It must be segregated and brought to an appropriate disposal facility to ensure proper recycling.

This is to be done in order to avoid negative impacts on the environment and human health.

Local waste management rules shall be observed and respected.

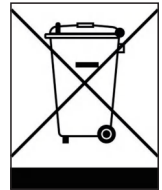

3.1 Select a Location to Install the Inverter

When selecting a location for the inverter, the following criteria should be considered:

- Exposure to direct sunlight may cause output power derating due to overheating. It is recommended to avoid installing the inverter in direct sunlight. The ideal location is one where the ambient temperature does not exceed 40°C.
- It is also recommended to install the inverter somewhere the rain and snow will not land directly on it. The ideal installation location is on a north-facing wall under an eave.

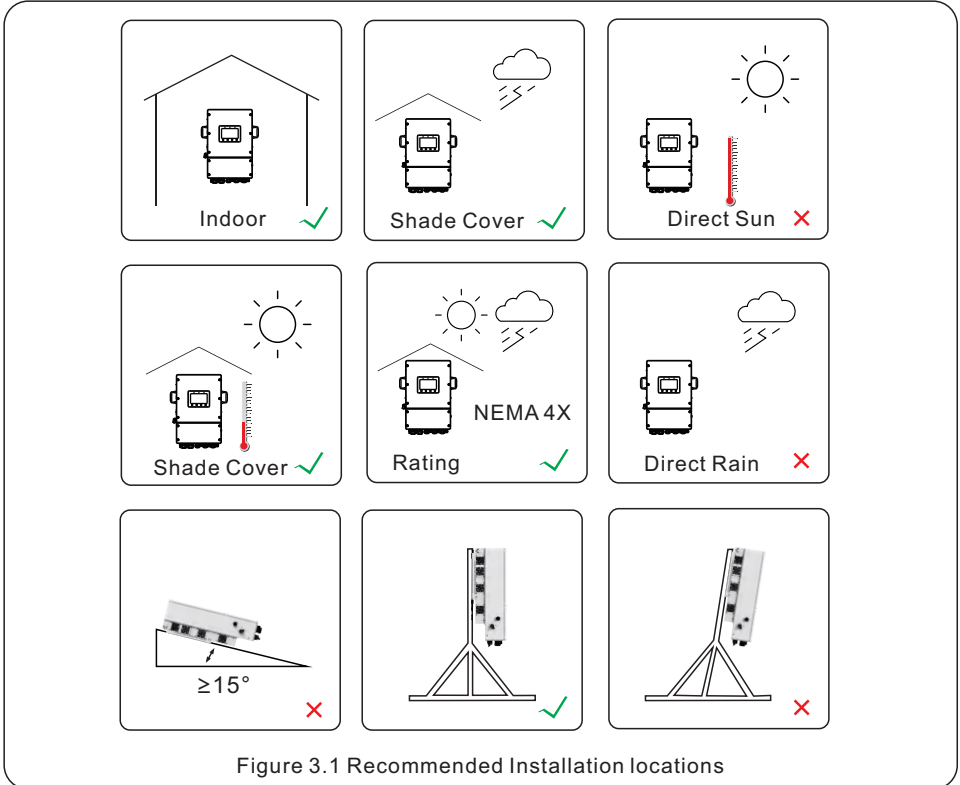

WARNING: Risk of fire



Despite careful construction, electrical devices can cause fires.

- Do not install the inverter in areas containing highly flammable materials or gases.
- Do not install the inverter in potentially explosive atmospheres.
- The mounting structure where the inverter is installed must be fireproof.

When selecting a location for the inverter, consider the following:



CAUTION: Hot Surface

- The temperature of the inverter heat-sink can reach 75°C.

The ambient temperature and relative humidity of the installation environment should meet the following requirements:

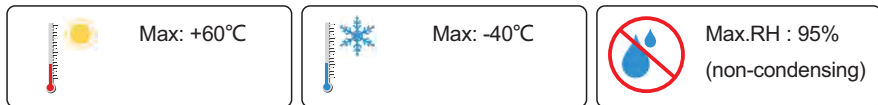

Figure 3.2 Installation environment conditions



Load bearing surface:

Made of non-inflammable materials

Max. load bearing capacity \geq 4 times of inverter weight

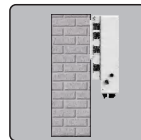

3.1.1 Clearances

The fan of the inverter is the left inlet wind, the right outlet wind .

To avoid overheating, always make sure the flow of air around the inverter is not blocked.

A minimum clearance of 300mm should be kept between objects;

A minimum clearance of 700mm should be kept between inverters;

In order to have enough space for installation and maintenance, we recommend that the front

distance is \geq 500mm,the bottom of the inverter should be

at least 500mm above of the ground or floor, which can be adjusted according to the actual situation.

3.1.2 Consult technical data

- Consult the technical specifications sections at the end of this manual for additional environmental condition requirements (temperature range, altitude, etc.)

3.1.3 Angle of installation

- This model of Solis inverter must be mounted vertically (90 degrees or backwards less than or equal to 15 degrees from 90 degrees straight up).

3.1.4 Avoiding direct sunlight

Installation of the inverter in a location exposed to direct sunlight should to be avoided.

Direct exposure to sunlight could cause:

- Power output limitation (with a resulting decreased energy production by the system).
- Premature wear of the electrical/electromechanical components.
- Premature wear of the mechanical components (gaskets) and user interface.

3.1.5 Air circulation

Do not install in small, closed rooms where air cannot freely circulate.

To prevent overheating, always ensure that the air flow around the inverter is not blocked.

3.1.6 Flammable substances

Do not install near flammable substances. Maintain a minimum distance of three meters (10 feet) from such substances.

3.1.7 Living area

Do not install in a living area where the prolonged presence of people or animals is expected. Depending on where the inverter is installed (for example: the type of surface around the inverter, the general properties of the room, etc.) and the quality of the electricity supply, the sound level from the inverter can be quite high.

3.2 Product Handling

Please review the instruction below for handling the inverter:

1. The red circles below denote cutouts on the product package - one per side.
Push in the cutouts to form handles for moving the inverter (see Figure 3.3).
2. Two people are required to remove the inverter from the shipping box. Use the handles integrated into the heat sink to remove the inverter from the carton.
3. When setting the inverter down, do it slowly and gently. This ensures that the internal components and the outer chassis do not take any damage.

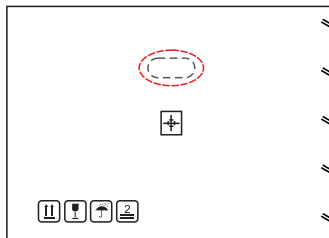
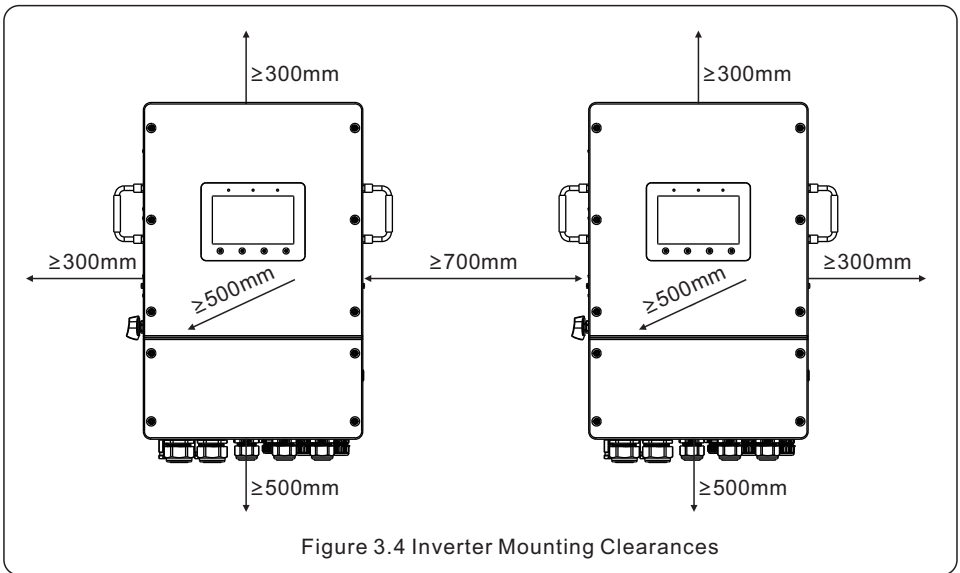

Figure 3.3

3.3 Mounting the Inverter

- Mount the inverter on a wall or structure capable of bearing the weight of the machine.
- The inverter must be mounted vertically with a maximum incline of +/- 5 degree. Exceeding this may cause the output power to derate.
- The fan of the inverter is the left inlet wind, the right outlet wind .To avoid overheating, always make sure the flow of air around the inverter is not blocked. A minimum clearance of 700mm should be kept between inverters and 300mm be kept from objects; In order to have enough space for installation and maintenance, we recommend that the front distance is $\geq 500\text{mm}$, which can be adjusted according to the actual situation.



- Visibility of the LED indicator lights should be considered.
- Adequate ventilation around the inverter must be provided.



NOTE

Nothing should be stored on the top of or placed against the inverter.

3.4 Inverter Wiring Overview

	Purpose	Connection Points
PV Cables	PV DC connection to the inverter	From the PV array to the DC+ and DC- terminals in the inverter
Battery Cables	Battery DC connection to the inverter	From the battery (+) and (-) terminals to the inverter BAT+ and BAT- terminals
AC Grid Cables	Inverter AC connection to the main service panel	From the OCPD in the main service panel to the AC-GRID L1, L2, L3 terminals
AC Backup Cables	Inverter AC connection to the backup subpanel	From the backup loads subpanel OCPD to the inverter AC-BACKUP L1, L2, L3 terminals
Ground Cables	Grounding conductors for the system	From the main service panel ground bar to the ground bar inside the inverter wire box
CT cable	Communication between inverter & CT	From meter to terminal HM. For more details, refer to figure Installing the energy meter
Battery communication cable	Communication between the inverter & the battery	From battery to terminal BMS. For more details, refer to figure Installing the battery
Data Logger (Optional)	Monitoring of the system on SolisCloud	USB COM port at the bottom of the inverter (For more details, please refer to the Solis data logger product manual)



NOTE

Conductor dimensions and OCPD sizing to be determined in accordance with the national electrical code (NEC) and local standards.

	(7-10)K-LV	(8-12)K	15K	18K
PV cable	4mm ² /6mm ² (12/10 AWG)			
Batt cable	33mm ² (2 AWG)			42mm ² (1 AWG)
AC grid port cable	6mm ² (10 AWG)	8mm ² (8 AWG)	10mm ² (6 AWG)	
Backup port cable	6mm ² (10 AWG)	8mm ² (8 AWG)	10mm ² (6 AWG)	
Smart port cable	6mm ² (10 AWG)	8mm ² (8 AWG)	10mm ² (6 AWG)	

3.5 Ground Cable Installation

An external ground connection is provided at the both sides of inverter.

Prepare OT terminals: M5. Use proper tooling to crimp the lug to the terminal.

Connect the OT terminal with ground cable to the right side of inverter. The torque is 3.3N.m.

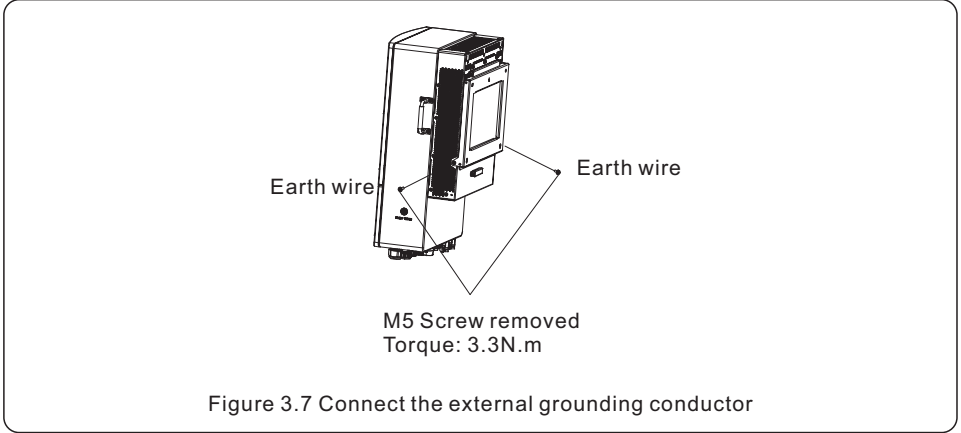

To connect the grounding terminal on the heat sink, please follow the steps below:

1. It is recommended to use copper wire for the chassis ground. Either solid conductor or stranded wire is acceptable. Refer to local code standard for wire sizing.
2. Attach OT terminal: M5.



IMPORTANT

For multiple inverters in parallel , all inverters should be connected to the same ground point to eliminate the possibility of a voltage potential existing between inverter grounds.

3. Strip the ground cable insulation to a suitable length.
4. Crimp a ring connector onto the cable and then connect it to the chassis ground terminal.

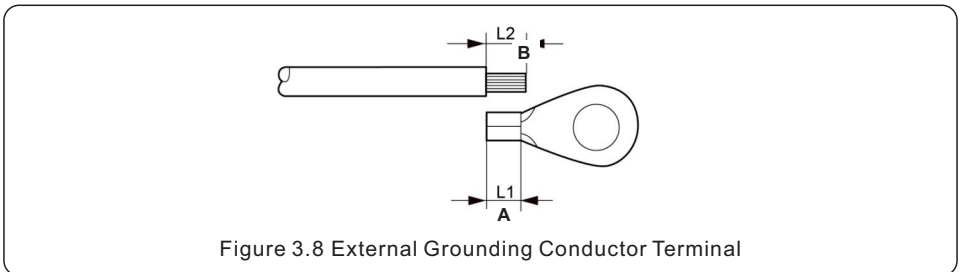

3.6 PV Cable Installation



Before connecting inverter, please make sure the PV array open circuit voltage is within the limit of the inverter.



Before connection, please make sure the polarity of the output voltage of PV array matches the "DC+" and "DC-" symbols.



Please use approved DC cable for PV system.

1. Select a suitable DC cable and strip the wires out by $7 \pm 0.5 \text{ mm}$. Please refer to the table below for specific specifications.

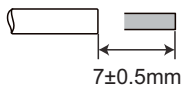

Cable type	Cross section (mm ²)	
	Range	Recommended value
Industry generic PV cable	4.0~6.0 (12~10AWG)	4.0 (12AWG)

Figure 3.9

2. Take the DC terminal out of the accessory bag, turn the screw cap to disassemble it, and take out the waterproof rubber ring.

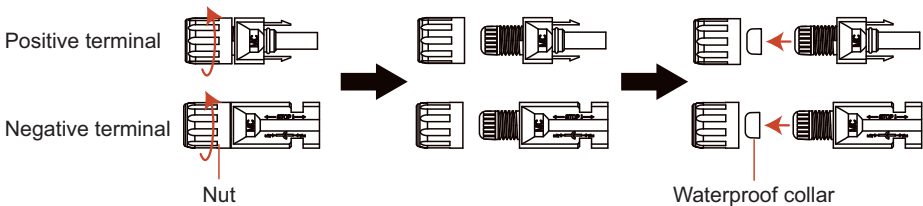
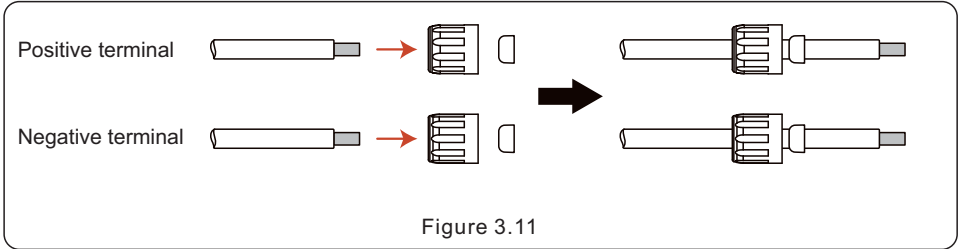
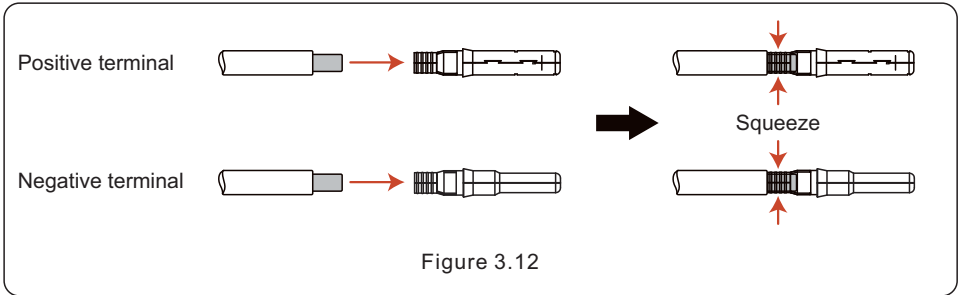

Figure 3.10

3. Pass the stripped DC cable through the nut and waterproof rubber ring.



4. Connect the wire part of the DC cable to the metal DC terminal and crimp it with a special DC terminal crimping tool.



5. Insert the crimped DC cable into the DC terminal firmly, then insert the waterproof rubber ring into the DC terminal and tighten the nut.

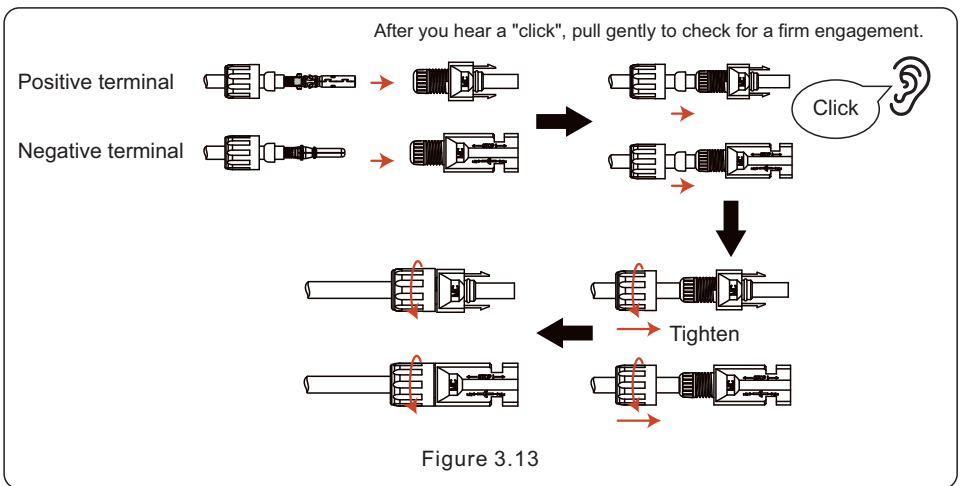

6. Measure PV voltage of DC input with multimeter, verify DC input cable polarity.

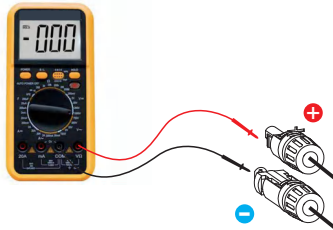

Figure 3.14

7. Connect the wired DC terminal to the inverter as shown in the figure, and a slight "click" is heard to prove the connection is correct.

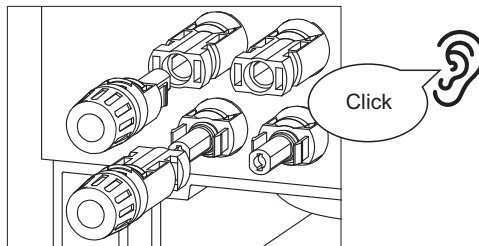

Figure 3.15



CAUTION:

If DC inputs are accidentally reversely connected or inverter is faulty or not working properly, it is NOT allowed to turn off the DC switch. Otherwise it may cause DC arc and damage the inverter or even lead to a fire disaster. The correct actions are:

*Use a clip-on ammeter to measure the DC string current.

*If it is above 0.5A, please wait for the solar irradiance reduces until the current decreases to below 0.5A.

*Only after the current is below 0.5A, you are allowed to turn off the DC switches and disconnect the PV strings.

* In order to completely eliminate the possibility of failure, please disconnect the PV strings after turning off the DC switch to avoid secondary failures due to continuous PV energy on the next day.

Please note that any damages due to wrong operations are not covered in the device warranty.

3.7 Battery Cable Installation



DANGER

Before installing the battery cables, be sure that the battery is turned off. Use a multimeter to verify that the battery voltage is 0Vdc before proceeding. Consult the battery product manual for instructions on how to turn it off.

1. The battery (+) and (-) cables shall only be connected to the inverter BAT terminals.
2. Run the cables into the wire box. Strip 13mm off the ends of each cable.
3. Crimp the R-type connectors onto the cables. Do not over crimp the connectors.
4. Remove the terminal bolts and then insert them through the connector holes.
5. Put each bolt back into the proper place, be sure to not reverse the polarity.
6. Tighten the bolts with a torque wrench screwdriver following the torque specs.

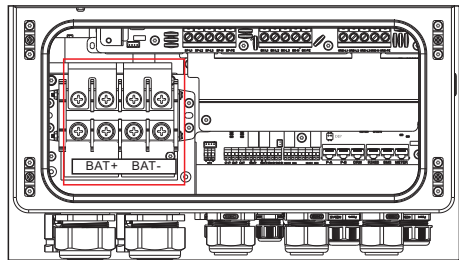
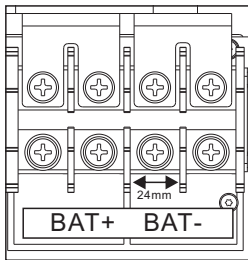

Figure 3.16 Battery cable connection

Terminal: M8 screws*4

(8-18)K Recommended cable diameter: 1AWG*4(42.41mm²*4)

(7-10)K Recommended cable diameter: 2AWG*4(33.62mm²*4)

The BAT+ terminal provides 2 inputs, each with a maximum of 175A.

The BAT- terminal provides 2 inputs, each with a maximum of 175A.



NOTE

Before connecting the battery, please carefully read the product manual of the battery and perform the installation exactly as the battery manufacturer specifies in the manual



NOTE

Please use the battery that has been matched by Solis. Please see the battery matching list on the Solis official website. If the battery is not in the list, our company will not carry out after-sales maintenance.

3.8 AC Wiring



DANGER

Before installing the AC cables, be sure that the OCPDs (breakers) are turned off.

Use a multimeter to verify that the AC voltages are 0Vac before proceeding.

There are three sets of AC output terminals and the installation steps for both are the same. The maximum temperature for connecting AC and battery terminals is 85°C.

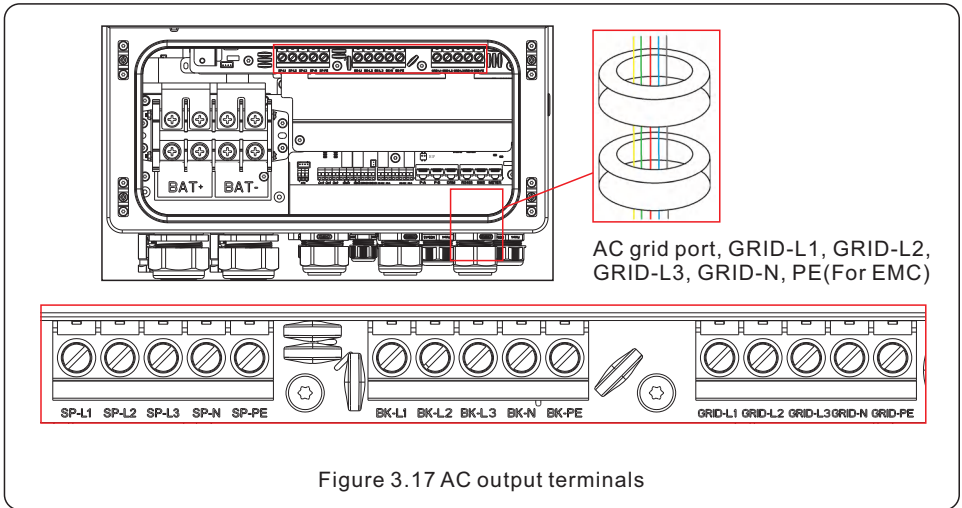

Figure 3.17 AC output terminals

Model	AC Grid	AC Backup/AC Gen	PE
Torque	4~5N.m	4~5N.m	4-5N.m
Recommend cross section	8~6AWG (6~10mm ²)	10~6AWG (4~10mm ²)	6AWG(10mm ²)

Pass the L1, L2, L3, N, (PE) of the AC grid port through two red magnetic rings

1. Bring the AC cables for the backup loads panel (backup) and the main service panel (grid) into the inverter wire box. The backup loads panel should not be electrically connected to the main service panel.
2. Strip 13mm from the ends of each cable. Crimp the R-type connectors onto the ends.
3. Remove the terminal bolts, insert them into the connectors, then use a torque wrench to tighten the bolts down.
4. Please refer to the terminal labels to connect the AC wires to the correct terminals.

3.9 CT Connection



CAUTION:

Make sure the AC cable is totally isolated from AC power before connecting the or CT.

3.9.1 CT Installation

The CT provided in the product box is compulsory for hybrid system installation. It can be used to detect the grid current direction and provide the system operating condition to hybrid inverter.

CT Model: ESCT-TA16-100A/50mA

CT Cable: Size – 2.3mm², Length - 1m

Please install the CT on the hot line at the system grid connection point and the arrow on the CT needs to point to the grid direction.

Lead the CT wires through the COM3 port at the bottom of the inverter and connect the CT wires to the 16pin communication terminal block.

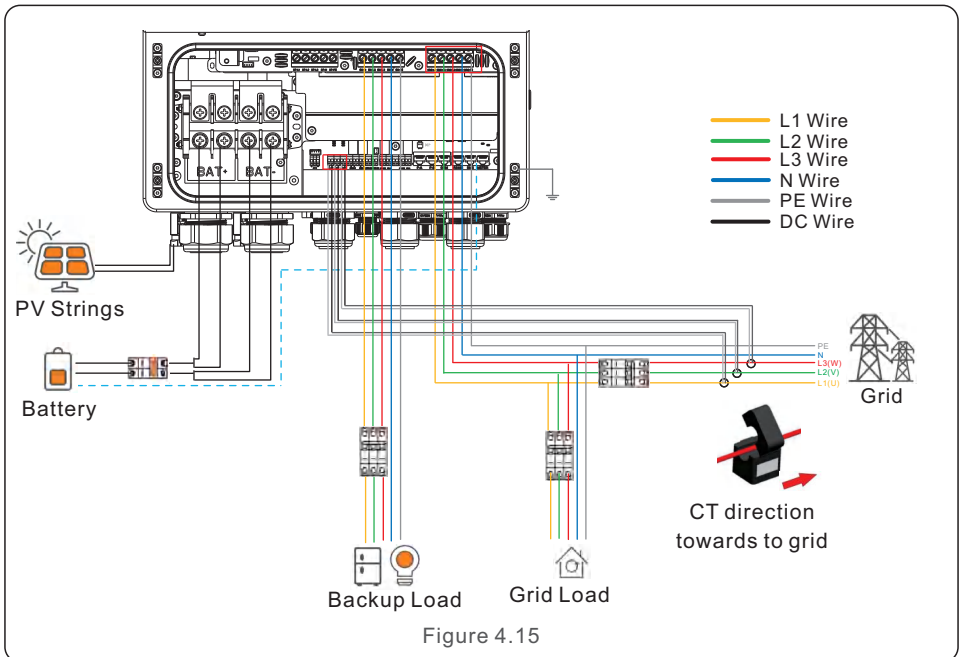

3.10 Inverter Communication

3.10.1 Communication Ports

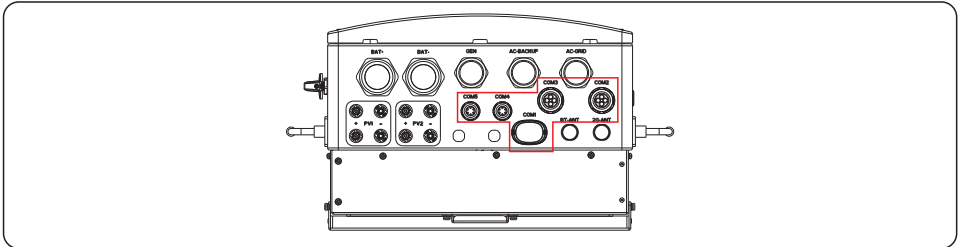

Port	Port Type	Description
COM1	USB	Used for Solis data logger connection
COM2	4 hole watertight cable gland	Used for RJ45 connection inside wiring box
COM3	4 hole watertight cable gland	Used for RJ45 connection inside wiring box
COM4	6 hole watertight cable gland	Used for 16 PIN terminal block connection inside wiring box
COM5	6 hole watertight cable gland	Used for 16 PIN terminal block connection inside wiring box

Wiring steps for COM2-COM5:

Step 1. Loose the cable gland and remove the watertight caps inside the cable gland based on the number of the cables and keep the unused holes with watertight cap.

Step 2. Lead the cable into the holes in the cable gland.

(COM2-COM3 Hole Diameter: 6mm, COM4-COM5 Hole Diameter: 2mm)

Step 3. Connect the cable to the corresponding terminals inside the wiring box.

Step 4. Reassemble the cable gland and ensure there is no bending or stretching of the cables inside the wiring box.



NOTE:

The 4-hole fastening rings inside the cable gland for COM2 and COM3 are with openings on the side.

Please separate the gap with hand and squeeze the cables into the holes from the side openings.

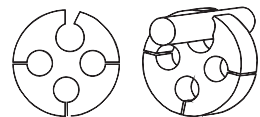

3.10.2 Communication Terminals

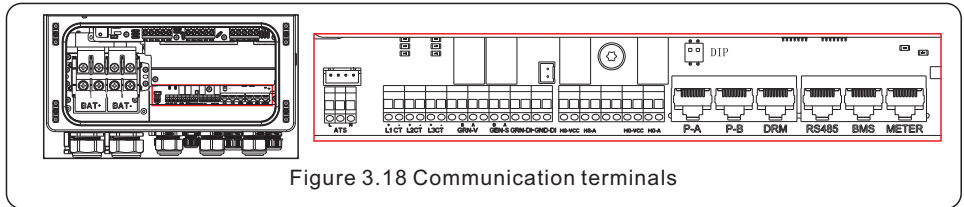

Figure 3.18 Communication terminals

Terminal	Type	Description
Meter	RJ45	Used for RS485 communication between inverter and the smart meter.
BMS		Used for CAN communication between inverter and Lithium battery BMS.
RS485		Third-party external devices.
DRM		(Optional) To realize Demand Response or Logic Interface function, this function may be required in UK and Australia.
Parallel B/ Parallel A		(Optional) Parallel operation communication port.
HS-VCC/ HS-A/ HG-VCC/ HG-A	Terminal Block	SG Heat pump.
GND-DI/ GEN-DI		Reserve(GEN signal).
GEN-S		Reserve.
GEN-V		Connect to GEN(Gen port).
L1CT/ L2CT/ L3CT		Connect to Cts.
ATS		Reserve.
DIP Switch	-	In parallel: Turn the DIP switch of the first and last inverter to: ON, and the other machines to OFF.

3.10.3 BMS Terminal Connection

3.10.3.1 With Lithium Battery

CAN communication is supported between inverter and compatible battery models.

Please lead the CAN cable through the COM1 or COM2 port of the inverter and connect to the BMS terminal with RJ45 connector.

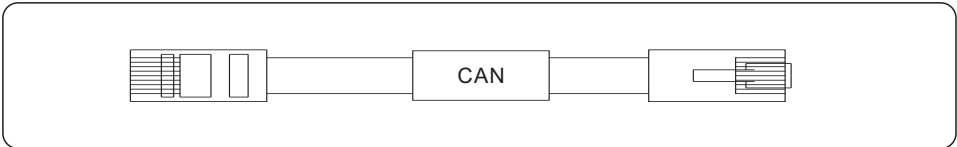

NOTE:



Before connecting CAN cable with the battery, please check whether the communication pin sequence of the inverter and the battery match; If it does not match, you need to cut off the RJ45 connector at one end of the CAN cable and adjust the pin sequence according to the pin definitions of both inverter and battery.

Pin definition of the inverter BMS Port is following EIA/TIA 568B.

CAN-H on Pin 4: Blue

CAN-L on Pin 5: Blue/White

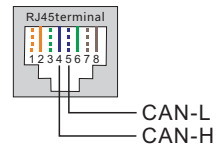

NOTE:



Before connecting RS485 cable with the battery, please check whether the communication pin sequence of the inverter and the battery match; If it does not match, you need to cut off the RJ45 connector at one end of the RS485 cable and adjust the pin sequence according to the pin definitions of both inverter and battery.

Pin definition of the inverter BMS Port is following EIA/TIA 568B.

RS485A on Pin 6: Green

RS485B on Pin 3: Green/White

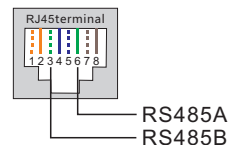

3.10.3.2 With Lead-acid Battery

When Lead-acid battery is used, battery temperature sensor needs to be connected to the BMS terminal of the inverter.

Step 1. Take out the battery temperature sensor cable and lead through the COM1 or COM2 port of the inverter and connect the RJ45 connector to the BMS terminal.

Step 2. Fasten the temperature sensor ring onto the battery module. If no suitable fastening terminal can be found on the battery module, the sensor ring can be attached to the positive or negative pole of the battery module.

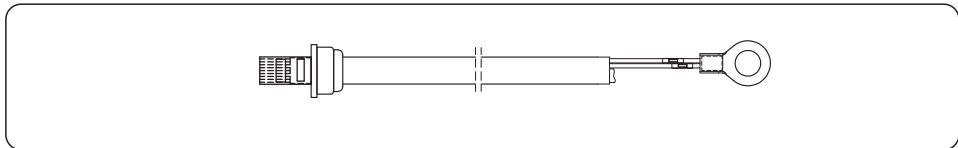

3.10.4 Meter Terminal Connection

If a smart meter is preferred to be installed other than the provided CT, please contact Solis sales rep to order the smart meter and corresponding meter CT.

Please lead the Meter RS485 cable through the COM1 or COM2 port of the inverter and connect to the Meter terminal with RJ45 connector.

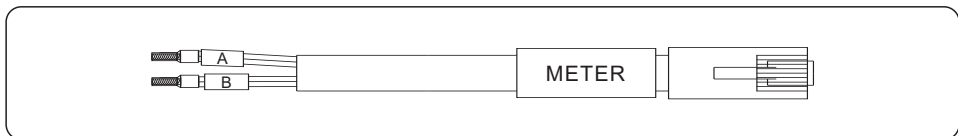

NOTE:

Pin definition of the Meter Terminal is following EIA/TIA 568B.

RS485A on Pin 1: Orange/white

RS485B on Pin 2: Orange

Eastron SDM630MCT – Pin 13 is RS485B & Pin 14 is RS485A.

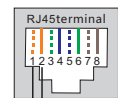

RS485B
RS485A

Meter Configuration: 40mA Meter+120A/40mA CT;

MODEL: SDM630MCT+ESCT-TA16

Separate Kit: 5A Meter+300A/5A

CT MODEL: SDM630MCT V2+ESCT-T50.

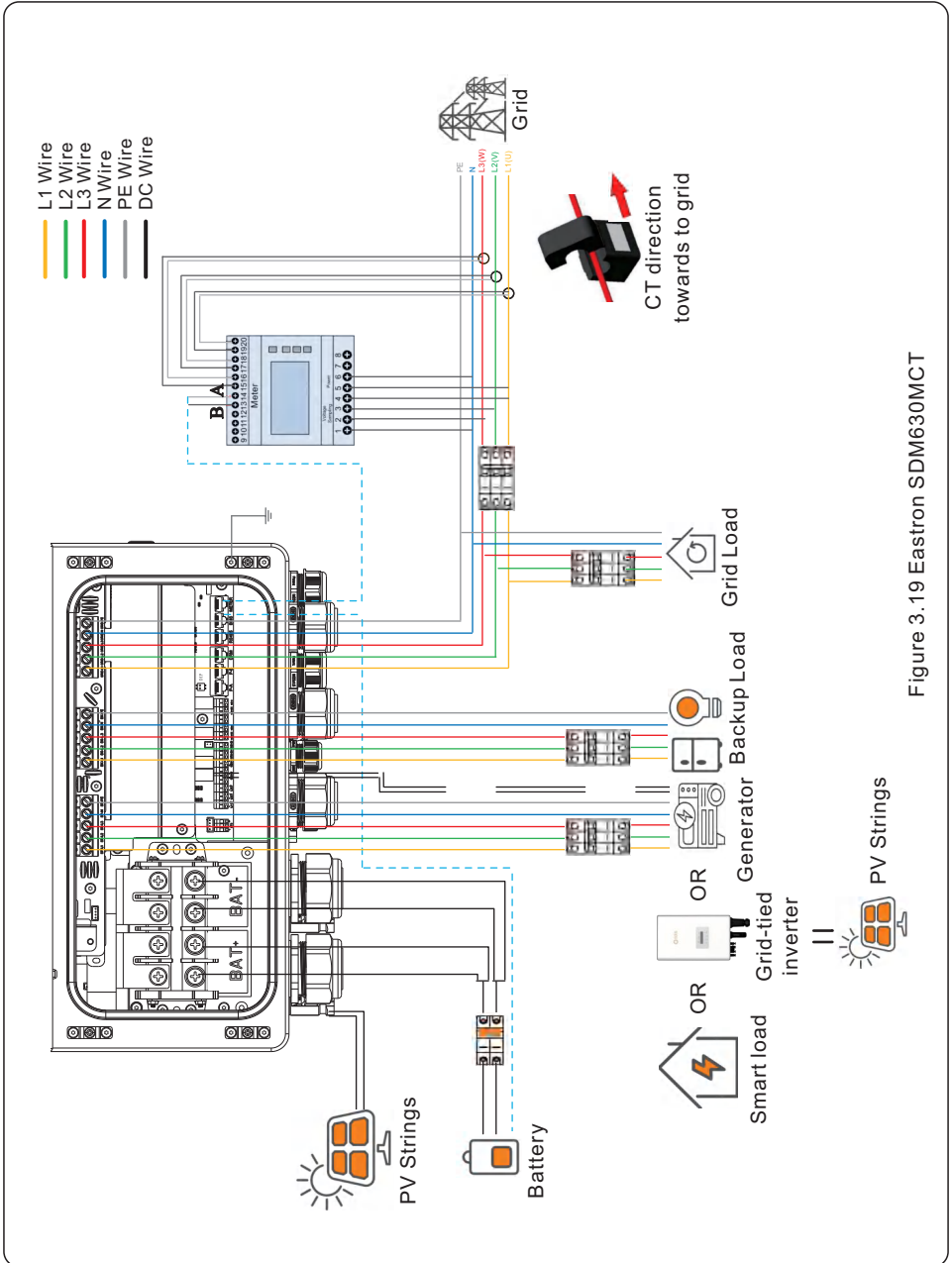

Figure 3.19 Eastron SDM630MCT

3.10.5 DRM Port Connection (Optional)

3.10.5.1 For Remote Shutdown Function

Solis inverters support remote shutdown function to remotely control the inverter to power on and off through logic signals.

The DRM port is provided with an RJ45 terminal and its Pin5 and Pin6 can be used for remote shutdown function.

Signal	Function
Short Pin5 and Pin6	Inverter Generates
Open Pin5 and Pin6	Inverter Shutdown in 5s

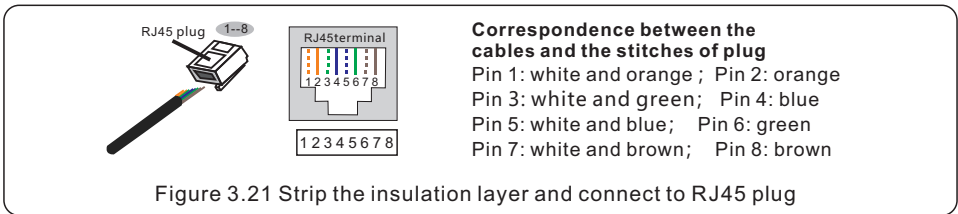
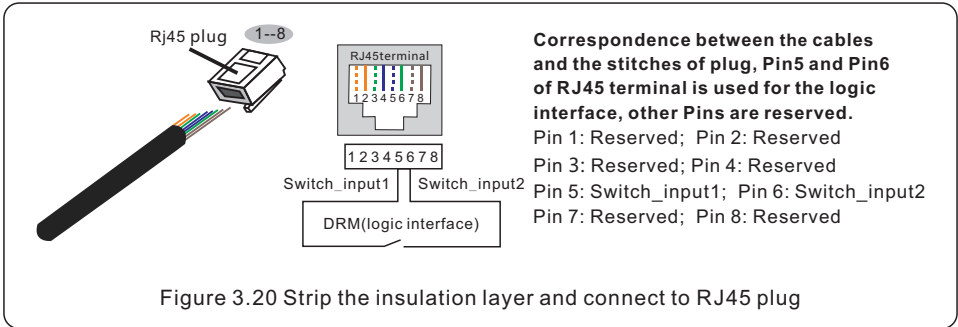

3.10.5.2 For Generating Power Limitation Function

Solis inverters support accepting switching signals from ripple control receivers to adjust the generating power limit of the inverter. The DRM port is provided with an RJ45 terminal.

Switching Signal	RJ45 Socket Asserted by shorting pins	Function
S0	Pin 5 and Pin 6	Keep inverter generating and ensure effectiveness of switching signal S1-S4 (Open Pin 5 and Pin 6 will shut down inverter)
S1	Pin 1 and Pin 7	Limit inverter power to S1 power limit (Default 0%)
S2	Pin 2 and Pin 7	Limit inverter power to S2 power limit (Default 30%)
S3	Pin 3 and Pin 7	Limit inverter power to S3 power limit (Default 60%)
S4	Pin 4 and Pin 7	Limit inverter power to S4 power limit (Default 100%)



NOTE:

S0 needs to be closed, so that S1-S4 can be effective. In case multiple switching signal from S1-S4 are received, inverter will perform power limitation in priority S1>S2>S3>S4. S1-S4 power limit can be adjusted in range 0%~100%.

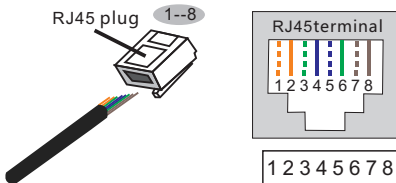

Correspondence between the cables and the stitches of plug
 Pin 1: white and orange; Pin 2: orange
 Pin 3: white and green; Pin 4: blue
 Pin 5: white and blue; Pin 6: green
 Pin 7: white and brown; Pin 8: brown

Figure 3.22 Strip the insulation layer and connect to RJ45 plug

3.10.6 RS485 Port Connection (Optional)

If a 3rd party external device or controller needs to communicate with the inverter, the RS485 port can be used. Communication protocol is supported by Solis inverters.

To acquire latest protocol document, please contact Solis local service team or Solis sales.



NOTE:

Pin definition of the RS485 Port is following EIA/TIA 568B.
 RS485A on Pin 5: Blue/White
 RS485B on Pin 4: Blue

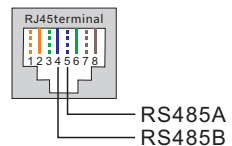

3.10.7 Parallel Inverter Connection (Optional)

In parallel-system scenarios, maximum support 6 parallel connections.

Parallel connection of different models is not supported.

(Like 12K and 15K can't be connected in parallel).

In parallel system, only one large battery can be used, BMS is connected to the master.

In the parallel system, each inverter is recommended to plug in the datalogger, otherwise, the remote upgrade cannot be performed.

Parallel cable use standard CAT5 (recommended distance ≤ 5 meters between two inverter) with shielding layers internet cable can be used.

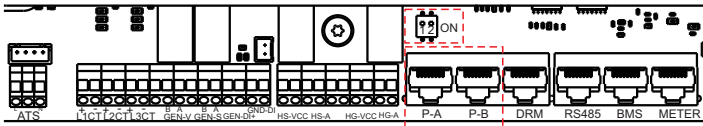

Figure 3.23

Step 1: Connect parallel cables to the parallel system use PAR-A and PAR-B.

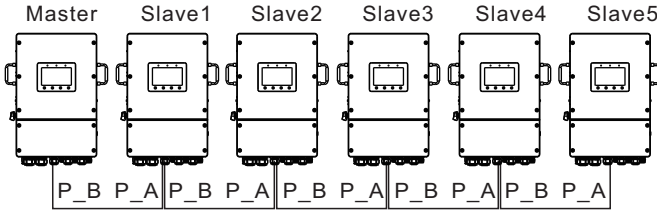

Figure 3.24 Parallel Terminal Connection

Step 2: Adjust the inverter DIP switch

Both the first and the last inverter(Master & Slave5(N)) have 2 DIP switches enabled (Both Pin1 & Pin2)

Step 3:Set parallel system

Refer to chapter 5.4.3 Detailed HMI Setting >>Step 8 Set parallel system.

The master inverter address is set to 1, the slave is 2, and so on. The address of the master must be 1.

3.10.8 16-pin Communication Terminal Block

Terminal Block Connection Steps:

Step 1. Lead the wires through the hole in COM3 port. (Hole Diameter: 2 mm)

Step 2. Strip the wires for 9mm length.

Step 3. Use slot type screwdriver to press the block on the top.

Step 4. Insert the exposed copper part of the cable into the terminal.

Step 5. Remove the screwdriver and the terminal will clamp down on the exposed copper part.

Step 6. Give the cable a gentle tug to ensure that it is firmly secured.

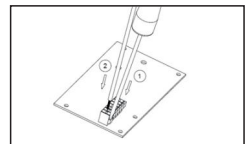

3.10.8.1 HM Terminal Connection (CT Terminal Connection)

CT connection is necessary to realize the correct control logic of the hybrid inverter.

The CT terminals are CT-L1 (±) / CT-L2 (±) / CT-L3 (±) from left to right.

The CT provided in the inverter package has BLACK(S2) and WHITE(S1) wires. The BLACK wire needs to connect to the Pin 2, Pin 4, Pin6 of the terminal block and the WHITE wire needs to connect to the Pin 1, Pin3, Pin5 of the terminal block as in the following diagram.

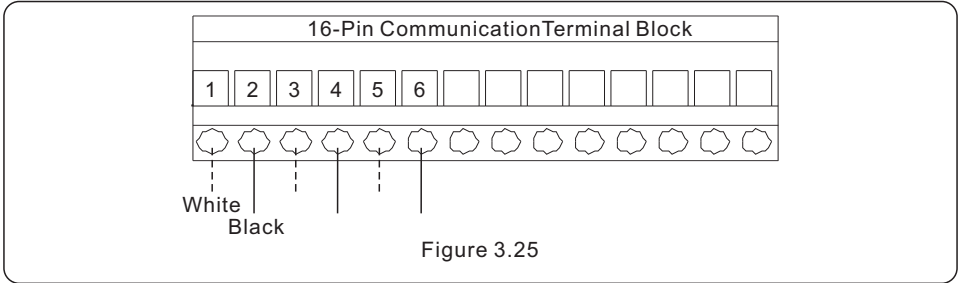

Figure 3.25

3.10.8.2 G-V Terminal Connection (GEN port)

The G-V terminal is a voltage-free dry contact signal for connecting with generator's NO relay to start up the generator when necessary.

When generator operation is not needed, Pin8 and Pin9 is in open circuit.

When generator operation is needed, Pin8 and Pin9 is in short circuit.

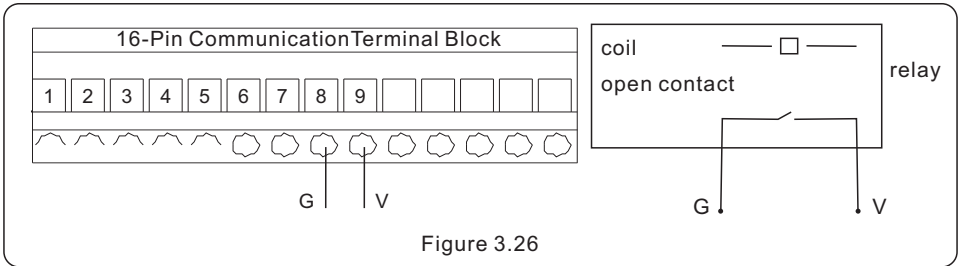

Figure 3.26

3.10.8.3 Heat Pump Control Signal Connection

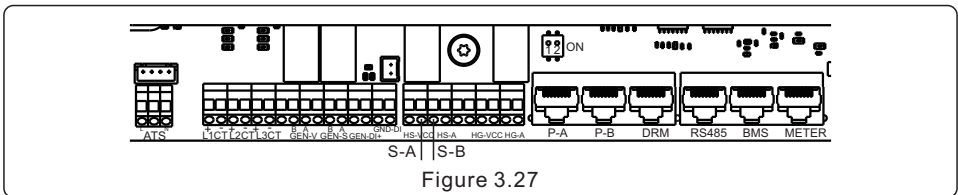

Figure 3.27

3.11 Inverter Remote Monitoring Connection

The inverter can be remotely monitored via WiFi, LAN or 4G.

The USB type COM port at the bottom of the inverter can connect to different kinds of Solis data loggers to realize the remote monitoring on Soliscloud platform.

To install Solis data loggers, please refer to corresponding user manuals of Solis data loggers.

The Solis data loggers are optional and can be purchased separately.

Dust cover is provided the inverter package in case the port is not used.



WARNING:

The USB type COM port is only allowed to connect Solis data loggers. It is forbidden to be used for other purposes.

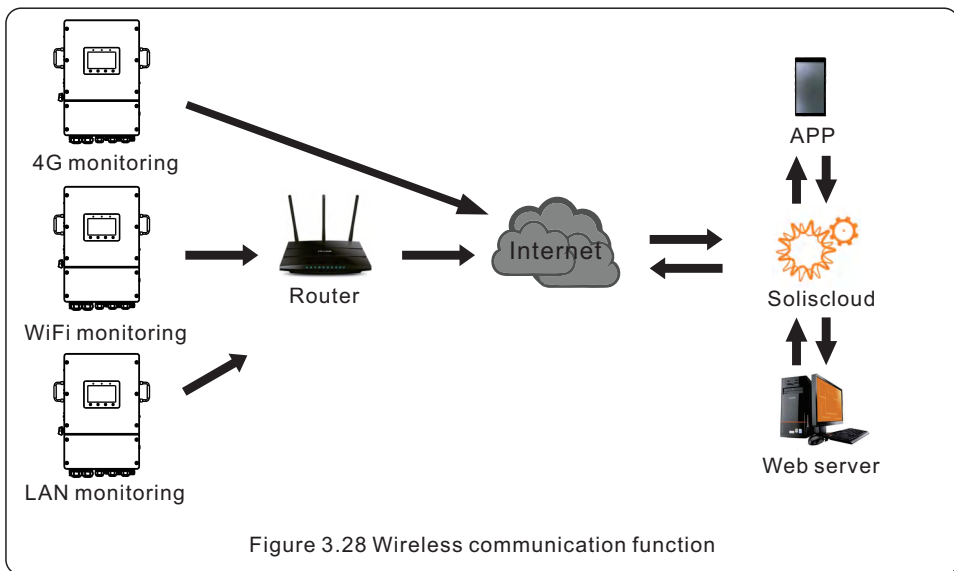
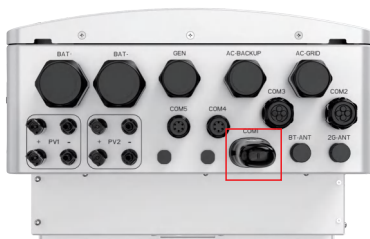

Figure 3.28 Wireless communication function

3.12 System wiring

3.12.1 Parallel wiring

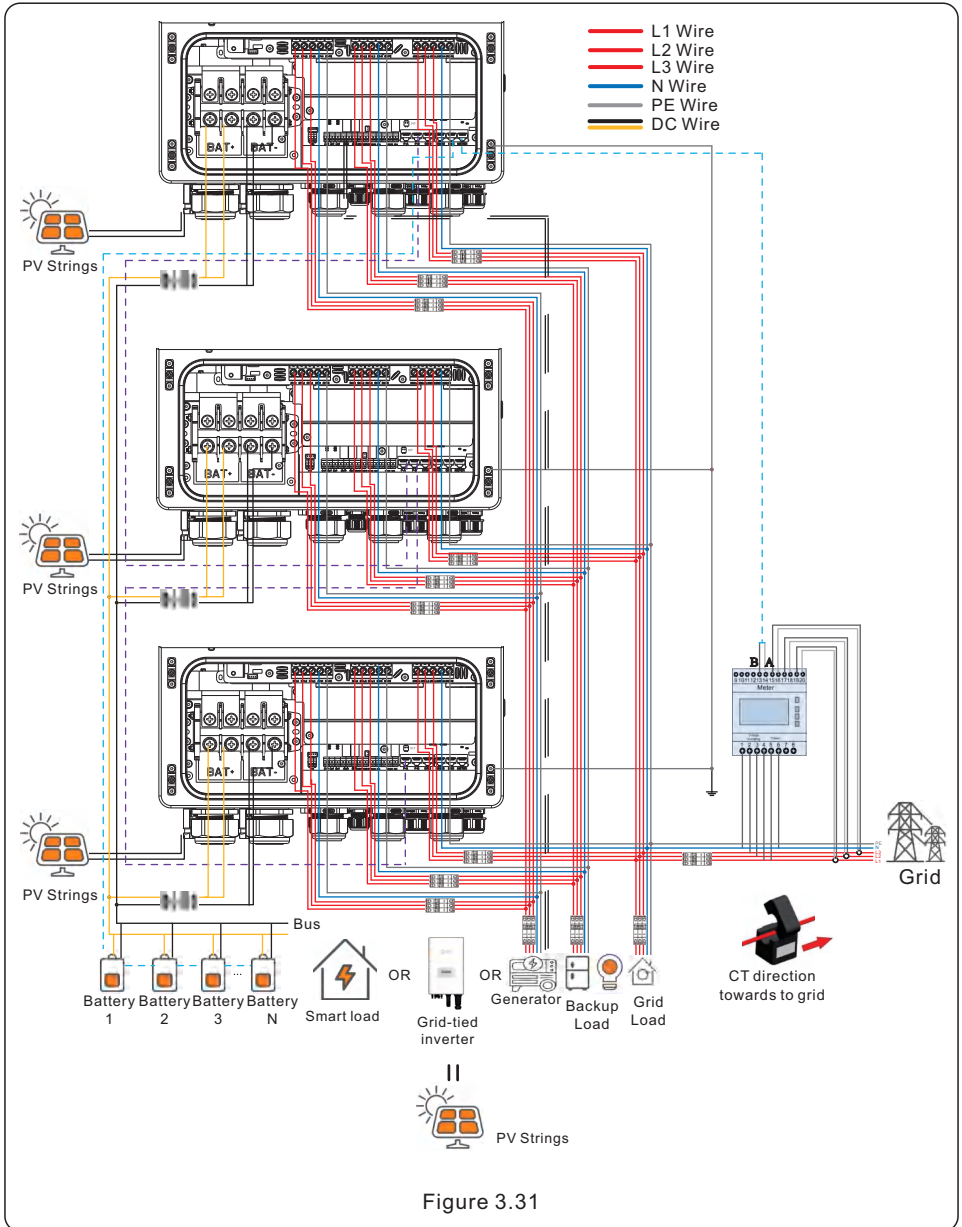
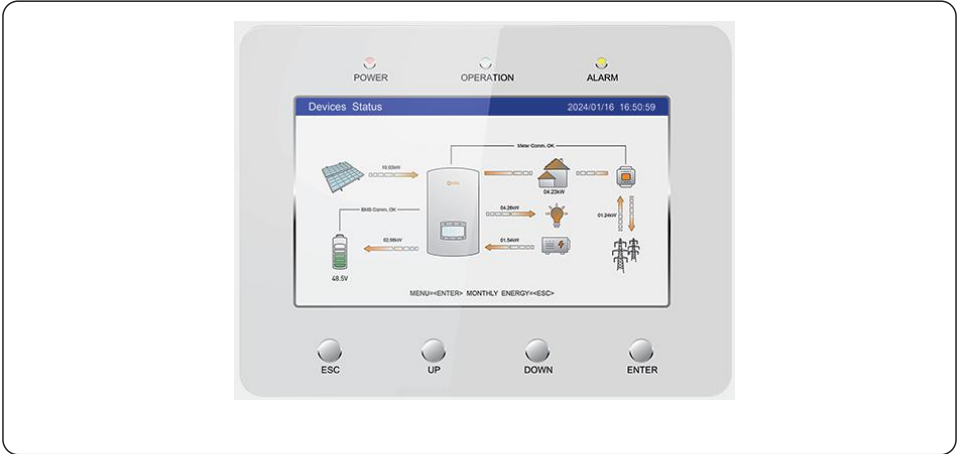

Figure 3.31

4.1 HMI Screen

There are 3 indicators and 4 operation button on the Solis S6 Series Inverter.



There are three LED indicators on the RHI inverter (Red, Green, and Orange) which indicate the working status of the inverter.

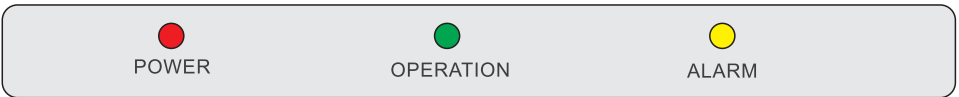

Light	Status	Description
● POWER	ON	The inverter can detect DC power.
	OFF	No DC power.
● OPERATION	ON	The inverter is fully operational.
	OFF	The inverter has stopped operating.
	FLASHING	The inverter is initializing.
● ALARM	ON	Emergency Fault.
	OFF	No fault condition detected.
	FLASHING	Warning and Normal Fault.

Table 4.1 Status Indicator Lights

Description of buttons:



Button	Description
ESC	“Escape”, allows the user to exit, or cancel the operation.
UP	Upwards key, allows the user to increase the value or move forward to the next option.
DOWN	Downwards key, allows the user to decrease the value or move backward to the previous option.
ENTER	Running or executing command .



NOTE:

The screen will be automatically turn off after being idle for a few minutes to save power, click any operation button(“ESC”/“UP”/“DOWN”/ “ENTER”) to restart the screen, then press“Enter”into the main operation interface.

4.2 Inverter built-in Bluetooth description

Bluetooth: BLE

frequency band(s) in which the radio equipment operates:2.402-2.480GHZ

Maximum transmitting power: 8dBm

Hereby, Ginlong Technologies Co.,Ltd.declares that the radio equipment type hybrid inverter is in compliance with Directive 2014/53/EU

5.1 Preparation of Commissioning

- Ensure that all the devices are accessible for operation, maintenance and service.
- Check and confirm that the inverter is firmly installed.
- Space for ventilation is sufficient for one inverter or multiple inverters.
- Nothing is left on the top of the inverter or battery module.
- Inverter and accessories are correctly connected.
- Cables are routed in safe place or protected against mechanical damage.
- Warning signs and labels are suitably affixed and durable.
- Bluetooth Antenna has been connected to the Antenna port of the inverter.
- An Android or IOS mobile phone with Bluetooth function is available.
- SolisCloud APP is installed on the mobile phone.

There are three ways to download and install the latest APP:

1. You can visit www.soliscloud.com to download the latest version APP.
2. You can search “**SolisCloud**” in Google Play or App Store.
3. You can scan this QR code below to download “**SolisCloud**”.



5.2 Commissioning Procedure

Step 1: Measure DC voltage of PV strings and battery and ensure the polarity is correct.

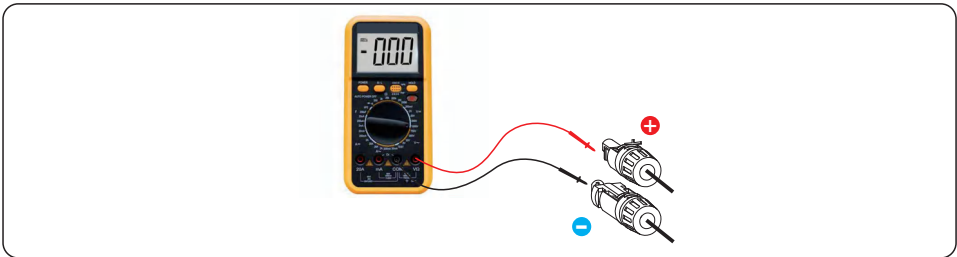

Step 2: Measure AC voltage and frequency and ensure they are within local standard.

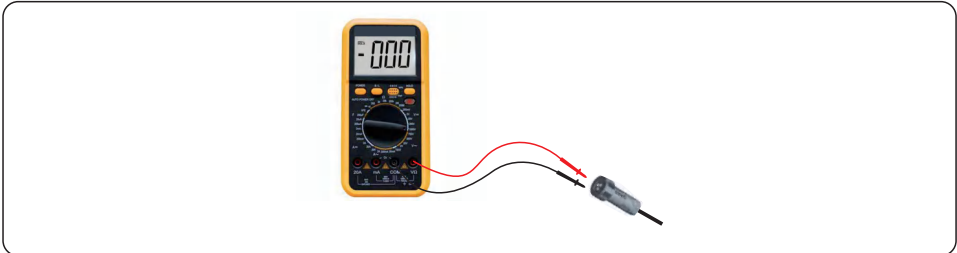

Step 3: Switch on the external AC breaker to power on the inverter control board.
(Bluetooth signal available)

5.3 Log in the APP via Bluetooth

Step 1: **Connect with Bluetooth.**

Turn on Bluetooth switch on your mobile phone and then open the SolisCloud APP. Click “More Tools”->”Local Operation”->”Connect with Bluetooth”

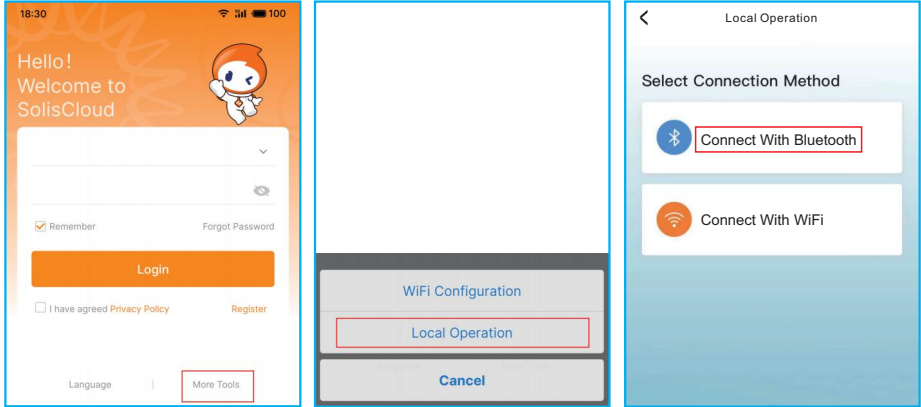

Step 2: Select the Bluetooth signal from the inverter. (Bluetooth Name: Inverter SN)

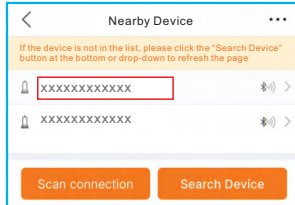

Step 3: **Login account.**

If you are the installer, please select the account type as Installer. If you are the plant owner, please select the account type as Owner. Then set your own initial password for control verification. (The first log-in must be finished by an installer in order to do the initial set up)

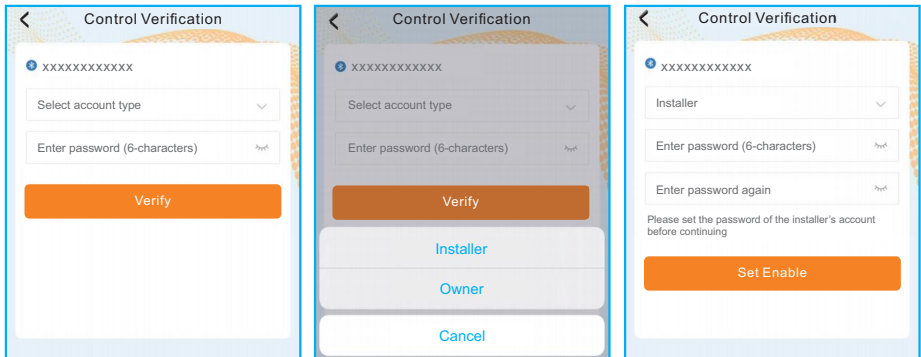

Step 4: After the log in for the first time, initial settings are required.

Step 4.1: Set the inverter date and time.

You can set to follow the time on your mobile phone.

Step 4.2: Set the battery model.

It must be based on the battery model that is actually connected to the inverter.

If there is no battery connected for the moment, please select “No Battery” to avoid alarms.

The default setting for battery over discharge SOC is 20%, force charge SOC is 10%.

Step 4.3: Set the meter setting.

It must be based on the meter type that is actually connected to the inverter.

If there is no meter connected for the moment, please select “No Meter” to avoid alarms.

It is suggested to install the meter at the system grid connection point and select “Meter in Grid”.

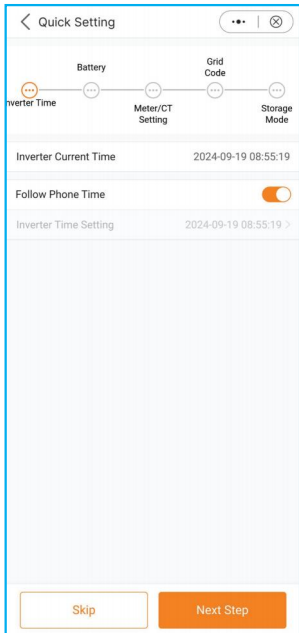

Step 4.1

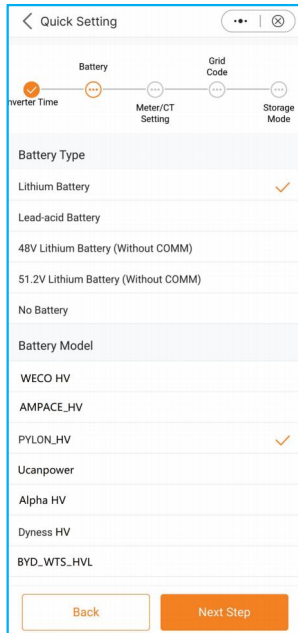

Step 4.2

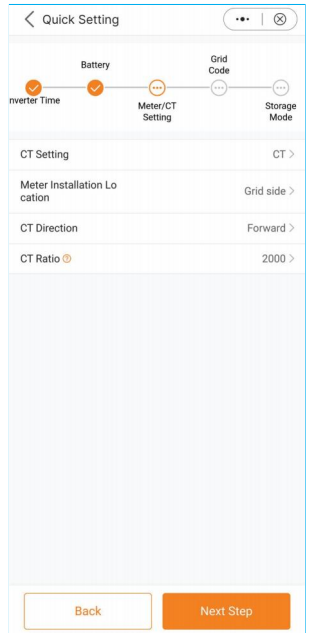

Step 4.3

Step 4.4: Set the grid code setting.

Please select the grid code based on the local grid network requirements. If the grid does not need to be connected to an N-Line, select disconnected.

Step 4.5: Set the work mode setting.

Recommended setting is Self-Use Mode. This mode will maximize the use of PV power generation for household electricity, or store it in batteries and use it for household electricity.

Allow export: Allow power output to the grid in Self-use mode. If you do not want to send power to the grid, do not turn it on.

Max export power: Limit the maximum power sold to the grid.

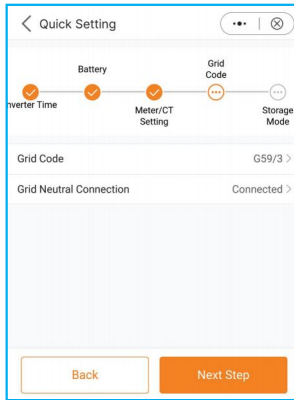

Step 4.4

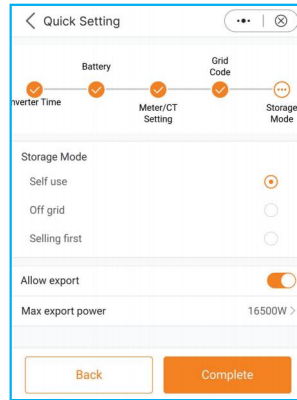

Step 4.5

Step 5: Setup complete.

Now the initial settings on the inverter have been set and you can switch on the inverter's DC switch and switch on battery breaker to start up the system. You can also explore in the APP to check the operating data, alarm message or other advanced settings.

5.4 Shutdown procedure

Step 1. Turn off the AC breaker at the grid connection point.

Step 2. Turn off the DC switch of the inverter.

Step 3. Turn off the battery breaker.

Step 4. Wait until the device is powered off, and the system shutdown is complete.

5.5 Work Mode and Settings

APP operation system overview

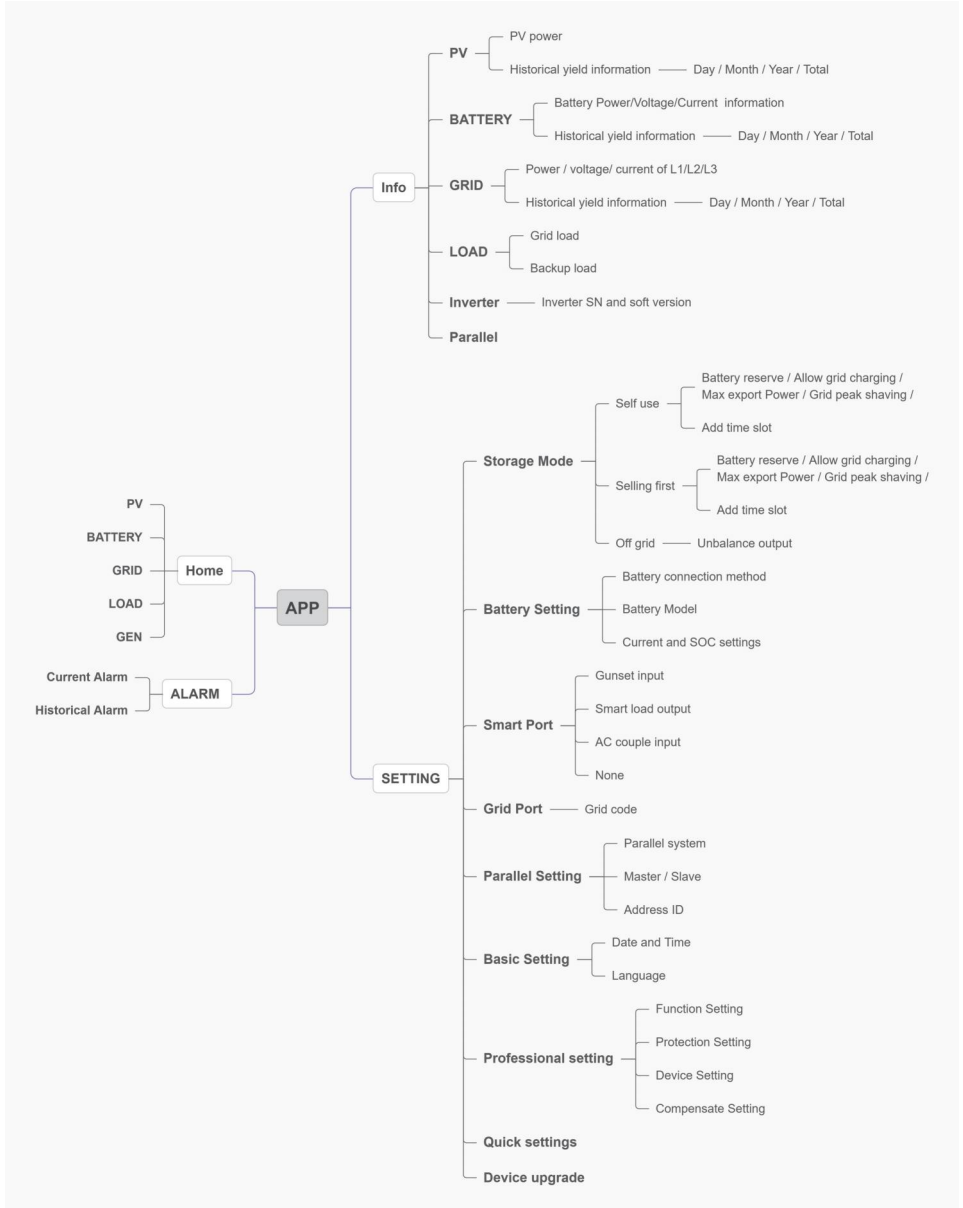

5.5.1 Self-Use mode

Load priority: load>battery>grid

Power supply priority: PV>battery>grid>DG

This mode applies to the area that has low feed-in tariff and high energy price.

The PV power will prioritize supplying energy to the load and charging the battery, with any surplus power being fed into the grid. During periods without PV power at night or when the PV power is insufficient, the battery will discharge to support the load.

- Supports TOU settings in this mode.
- Supports Battery Reserve function in this mode.

How to set Self-Use mode?

APP: setting--storage mode-self use

A. Self-Use Mode is activated without any specific times set for the battery to be charged/discharged, and the battery reserve is not switched on.

Note: Solis recommends activating the 'Allow Grid Charge' option. Once the battery reaches the Forcecharge SOC, it will use the grid to charge the battery, preventing it from being deep discharged.

B. The Self-Use Mode provides you with the option to set a Battery reserve value. Please toggle the switch to activate the battery reserve mode.

C. The Self-Use Mode provides you with the option to set whether allow power output to the grid and the max value.

D. If there is an error with your meter or CTs, open "Export power calibration" to calibration; In addition, you can set a small negative value(like:-50W)to ensure that no power is sent to the grid to achieve Zero export Power.

E. When your load is unbalanced in the three-phase distribution, turn on unbalanced output. Supports 150% Unbalanced Loads on both the Grid and Backup Port, single-phase load 1/2 rated power.

F. You can set the value of Grid peak shaving, Limit the power that inverters can obtain from the grid to prevent exceeding regulatory requirements or the power line capacity due to excessive power.

G. With the Add time slot, you can customize 6 stages of charging and 6 stages of discharging in one day.

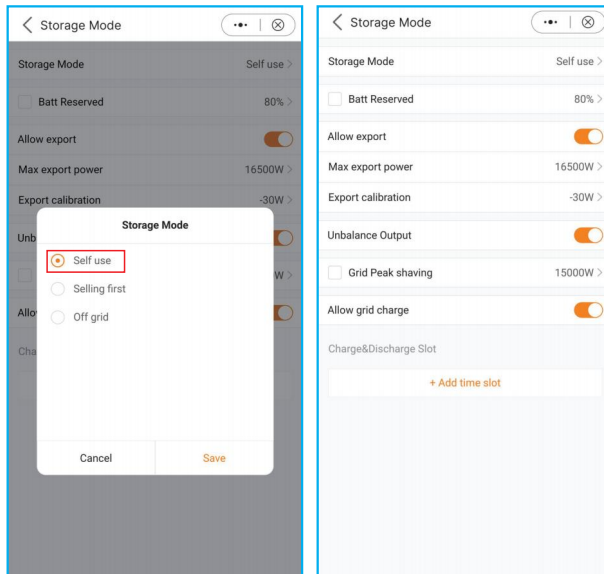

Batt reserved: Lithium battery: default 80%, adjustable range (the recommended value is more than 80%, to ensure that the battery has enough energy to supply the load after the grid is off ;

Lead acid battery: Default 100%, cannot be set.

Allow export: Allow power output to the grid in Self-use mode. If you do not want to send power to the grid, do not turn it on.

Max export power: Limit the maximum power sold to the grid.

Export power calibration: As some CTs/meters may have errors in practical applications, this setting value can be used for compensation. The range is "-500w ~ +500w"

Unbalanced output: Allow three-phase output imbalance, single-phase maximum load 50% of rated power. For example: 15kW inverter, single-phase maximum load 7.5kW.

Balance output: three phase output is the same, for example: 15kW inverter, per phase output is 5kW.

Grid peak shaving: Limit the power that inverters can obtain from the grid to prevent exceeding regulatory requirements or the power line capacity due to excessive power.

When the grid supplies power to the load while charging the battery, it will limit the power used to charge the battery, so that the total power does not exceed the set value.

If the grid only supplies power to the load and does not charging the battery, it is not limited by the setting value.

Allow grid charging: Allow the battery to be charged by the grid.

Charge/Discharge Slot: When the time is between Start and Stop, the system will charge/discharge the battery according to the set Current until the set "SOC/voltage" is reached.

5.5.2 Selling first mode

Load priority: load>grid>battery

Power supply priority: PV>battery>grid>DG

This mode applies to the area that has high feed-in tariff and export control.

The PV power will prioritize supplying energy to the load. Then any surplus is directed into the grid.

If there is a feed-in limitation, the excess power will charge the battery.

- Supports TOU setting in this mode.
- Supports Battery Reserve function in this mode.

How to set selling first mode?

APP: setting--storage mode--selling first

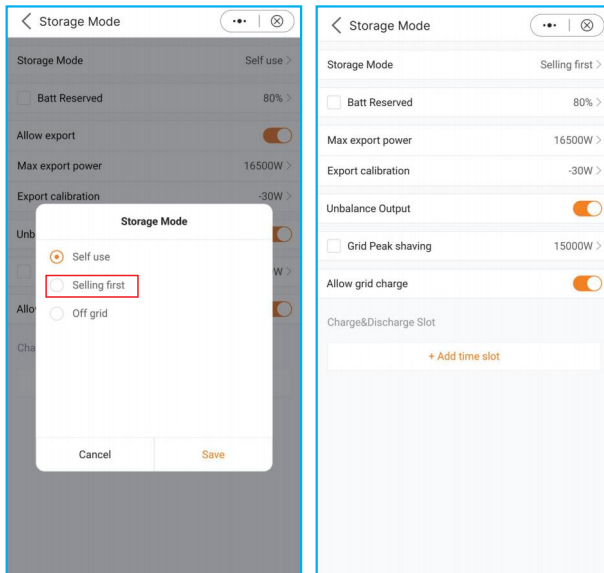

5.5.3 Off-Grid mode

Load priority : load>battery

Power supply priority: PV>battery>DG

- This mode applies to the area not covered by the grid or when the system is not connected to the grid.
- When a power outage is detected in a grid-tied system, the system will automatically will automatically enter in the off-grid, supplying only the backup load.
- The user can also manually set this mode, supplying only the backup load.

How to set Off-Grid mode?

APP: setting--storage mode--off-grid

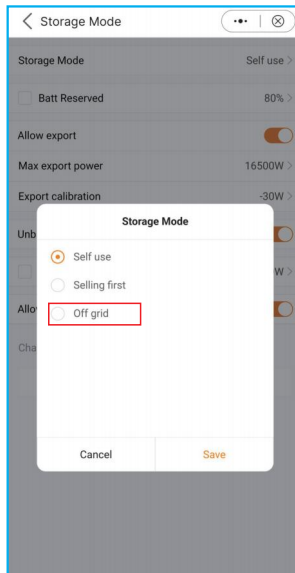

5.5.4 Peak shaving mode

Step1 :

setting--Grid peak shaving(turn on and set the limit value)

Step2 :

Setting--Professional(password: 0010)--Function Setting--peak shaving.

In this mode , Power supply priority:

PV>grid>battery>DG(when BAT SOC≤baseline SOC);

PV>battery>grid>DG(when BAT SOC≥baseline SOC);on the premise that the power supplied by the grid does not exceed the set value(P_max), the system will be trying to charge the battery to Peak SOC.

If($P_{\text{discharge}} + P_{\text{max}} + PV < P_{\text{load}}$), it will exceed the set value(P_{max})to support the load.

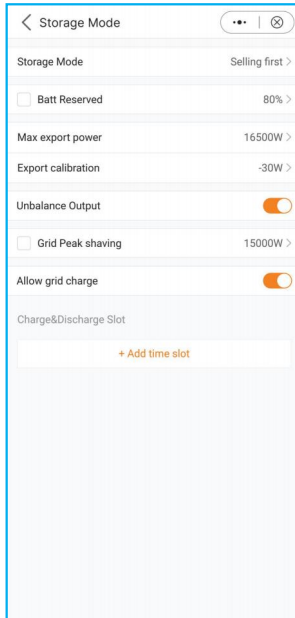

Step1

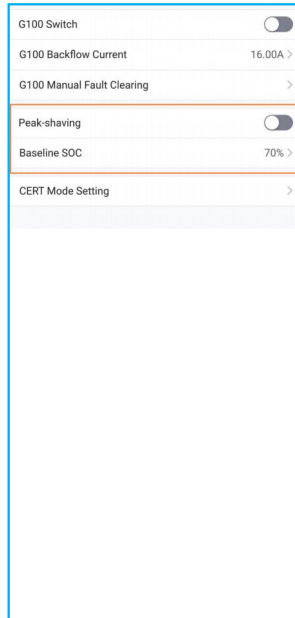

Step2

5.6 TOU Function Settings

This function applies to the area with peak-valley price. Set the system to charge the battery in valley price and discharge in peak price to improve benefits.

Supports 6 customizable charge/discharge time settings, while the battery will charge/discharge at a set current.

Supports TOU function settings in self-use mode, feed in priority mode.

There are 6 customizable charging settings and 6 customizable discharging settings.

How to set TOU Function?

Press "+Add Time Slot" to add a charging/discharging time period.

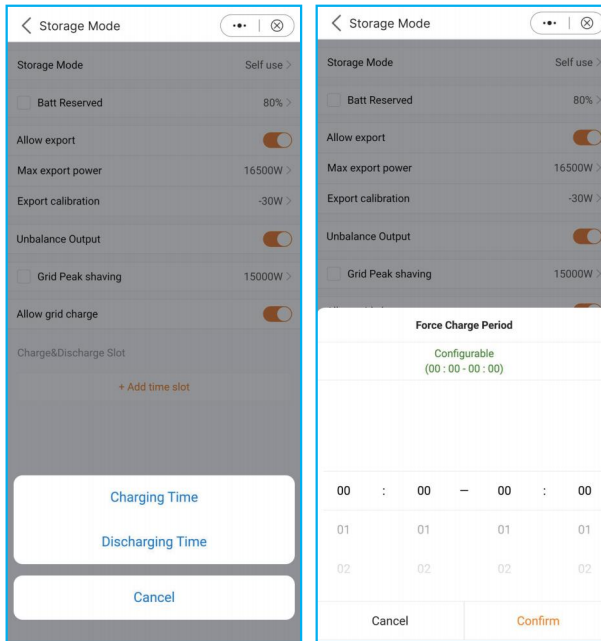

NOTE:

The set current value is the maximum current for charging/discharging the battery. However, the actual charging and discharging current may not reach this value due to the influence of other factors, such as the maximum charging/discharging power limitation of the inverter, the battery BMS limitation, etc.

5.7 Battery Settings

The battery section of the app offers numerous options to customize the interaction between the inverter and the battery. Here, we provide explanations for the functions and features available in this section, allowing users to tailor the inverter's behavior to their specific preferences and requirements.

Battery Type: Please select the correct Type of the battery. Lead-acid battery and lithium battery.

Battery Mode: Please select the correct model of the battery. If you don't have a battery, choose "No battery" to ensure accurate configuration.

Max Charging/Discharging Current: Choose the maximum charge/discharge current that you wish to. This selection allows you to customize the charging and discharging parameters based on your preferences and requirements.

Overdischarge SOC: The Overdischarge SOC (State of Charge) is the minimum battery charge level to which the inverter will discharge. It acts as a safeguard to prevent the battery from discharging beyond this specified threshold, ensuring its longevity and health.

Recovery: The battery can discharge when the SOC/Voltage reaches the set value. After the battery reaches the overdischarge SOC, it continues to charge to the recovery SOC before discharging. So that the battery SOC will not always hover over the overdischarge SOC.

Forcecharge: The Forcecharge SOC for the battery is the minimum state of charge(SOC) at which the inverter initiates charging the battery from the grid. It specifies the threshold below which the inverter actively engages in recharging the battery to maintain optimal performance.

Battery saving: Reduce battery loss. The necessary power for the operation of the inverter preferentially obtains from the grid, not from the battery.

Max charge SOC: The maximum SOC/Voltage that the battery can be charged to. Default 100%. Some batteries may alarm overvoltage when fully charged, and limiting protection will not be triggered if not fully charged.

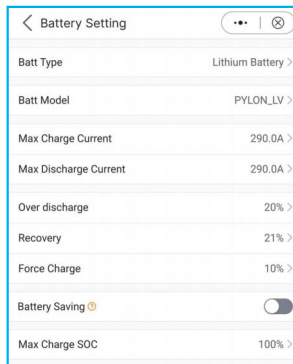

5.8 Battery Functions setting

If you need more Function Settings for the battery, you can go to Setting--Professional Setting--Function Setting.

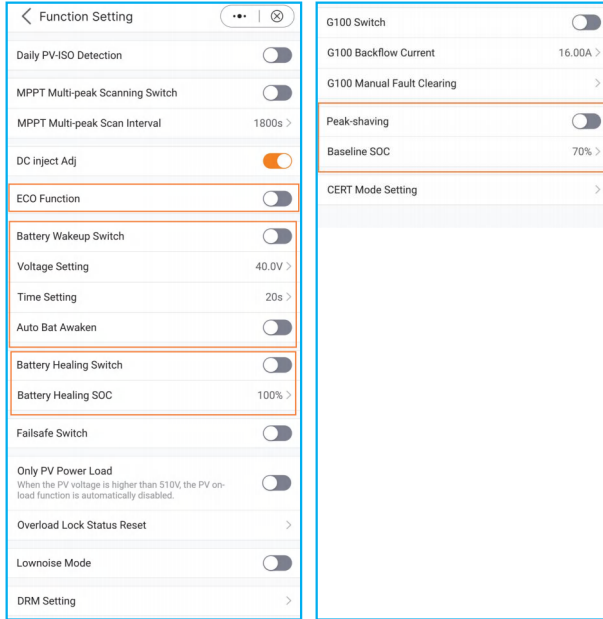

ECO function: To protect the battery, If PV power is lower than 100W and SOC below overdischarge SOC, The inverter will take power from the grid instead of battery, to maintain standby state,indicator and communication.

Battery Wakeup Switch: Battery wake-up can be supported in case of only PV or only Grid. This function supports manual and automatic operation, the battery can be awakened from the dormant state and charged above the overdischarge SOC.

Wake up voltage&time can be set:

Voltage: default 120V, range :120-600V;

Time: default 180s,range :20s-300s;

The wake up current depends on the battery, up to 6A.

Battery Healing Switch: When the lithium battery maintains low power for a long time, the battery SOC measurement is not accurate, It is necessary to charge the battery to 100 % from low power level to ensure the healthy and stable operation of the battery. Working logic: PV+grid charge the battery from Forcecharge SOC to overdischarge SOC , then grid stops charging, PV gives priority to charging the battery to Battery Healing SOC. And the battery does not discharge before reaching the set Battery Healing SOC.

5.9 Smart port settings

5.9.1 Generator setting

APP: setting--Smart Port

- A. Select Genset input
- B. Set the Genset rated power.
- C. When you want to manually control the start and stop of the generator, enable needs to be selected.
- D. When you want the generator to automatically start and stop according to the battery SOC, please select the Automatic.

The generator will start when the battery SOC drops to the ON SOC, and stop when the SOC reaches the OFF value.

The ON SOC should be more than over discharge SOC, it is recommend more than 10%.

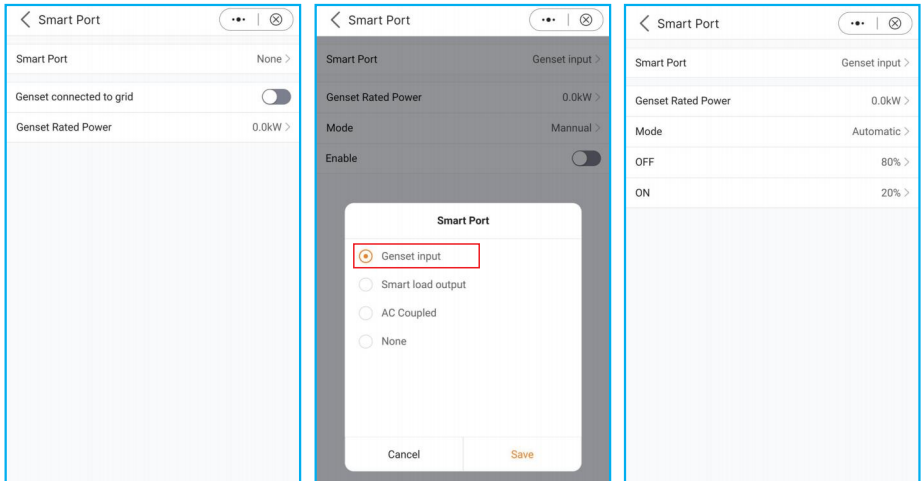

5.9.2 AC coupled setting

APP: setting--Smart Port

A. Select the AC couple input.

B. Set the Max frequency according to the specification of the PV inverter.

The hybrid uses Freq-Watt to control the output of the PV inverter. Please consult with the PV inverter's manufacturer to confirm the correct setting procedures of its Freq-Watt response first. Max freq is recommended: first-level overfrequency value +0.1Hz.

When SOC \geq 85%, Hybrid raises the frequency to the set value, stop inverter.

C. Set Max Export Control, Base on Export Power&SOC, When the export exceeds the limit value for a certain period of time, the inverter will disconnect the relay of the smart port.

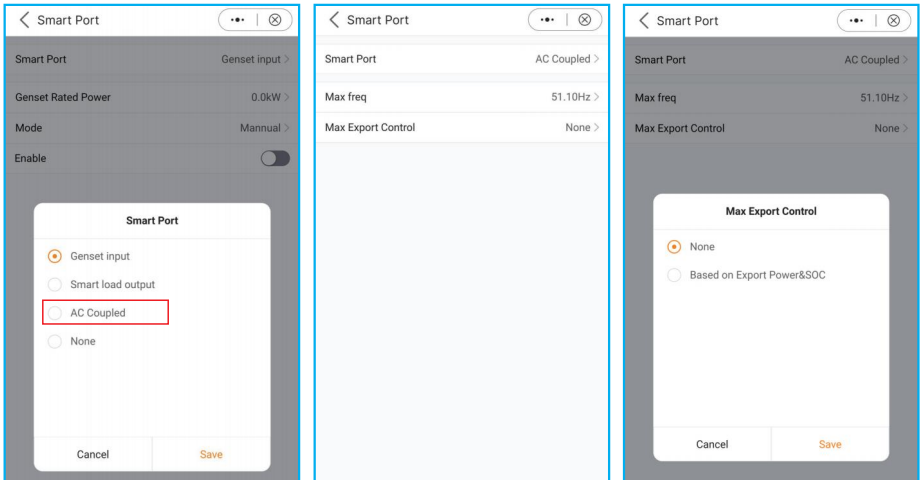

5.9.3 Smartload setting

APP: setting--Smart Port

A. Select Smart load output.

B. Select On grid always on or Off grid always off

On grid always on: smart port will always supply power to smart load when the grid is available.

Off grid always off: smart port will cut off power supply to smart load when the grid is off.

C. Set the OFF value and ON value to control the on/off of the load based on the battery level.

When the battery SOC/Volt drops to the OFF SOC/Volt, the system will cut off the power of smart load to ensure sufficient power for Backup load. When the battery SOC/Volt reaches the ON SOC/Volt, the smart port will supply power to smart load.

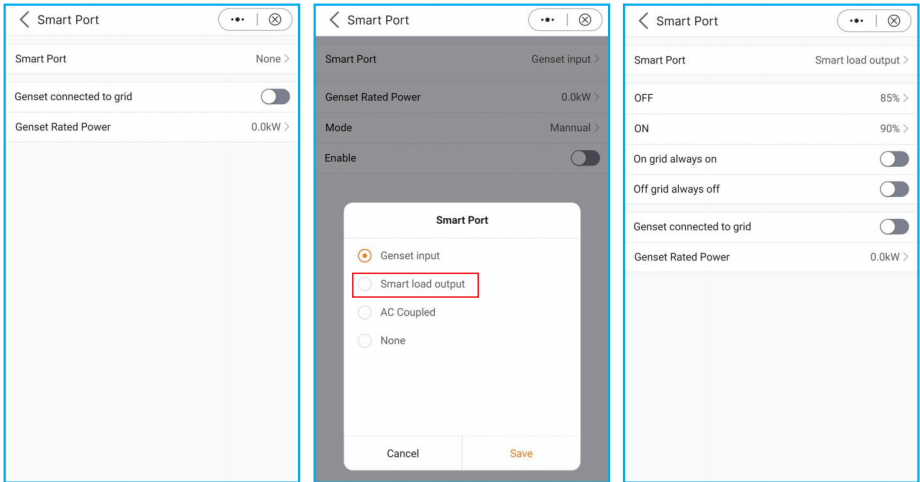

5.10 Grid port settings

APP: setting--Grid Port

Select grid code that meet the local regulations; If the grid is three-phase and three-line, choose Disconnected the N-line.

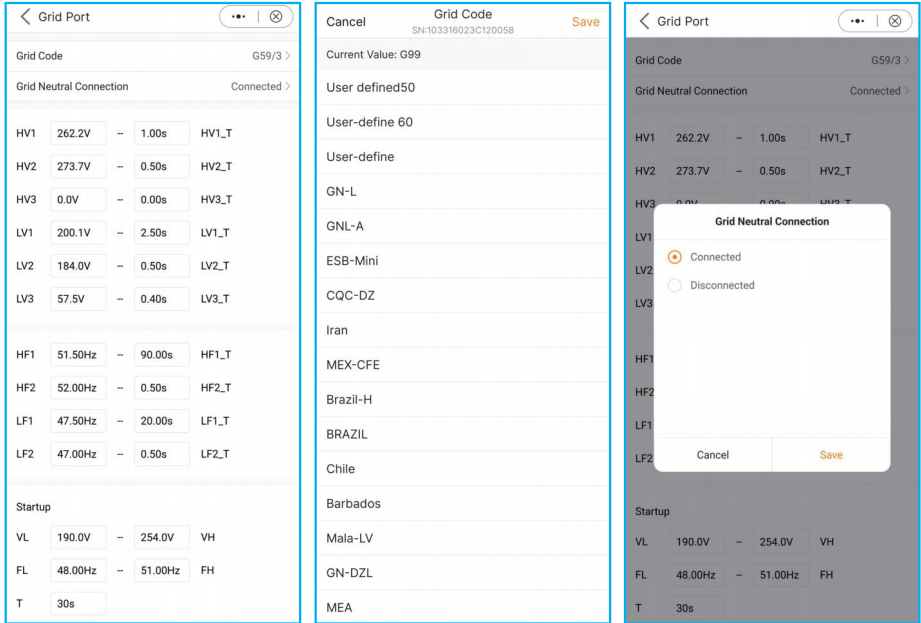

5.11 Parallel Settings

APP: setting--Parallel setting

The first inverter must be set as the Master.

The first inverter address is set to 1, the second to 2, and so on

(Note: that the address cannot be set to 0 and the physical address of the master must be 1)

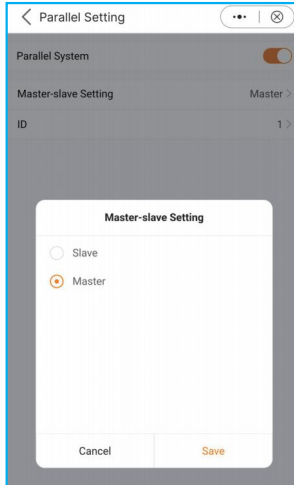

5.12 Only PV power load function

1. Function Definition

For PV generation is not stable, the default setting of S6 energy storage machine don't support only PV power the load.

But for meeting the some customers' special requirements, we develop the **Only PV Power Load** function, when the PV power > the load power, you can use this function.

Because the PV power is not stable and the load is also not always stable, it is possible to happen that PV power < load power, when it occurred, the load will shut down and **after 3 minutes**, the inverter tries to restart the load for the first time, **after 5 minutes**, the second time, and **after 10 minutes**, the third time. If the third attempt to restart the load is still not successful, the inverter will not try to restart, and it needs to be manually reset and restarted.



NOTE:

1. Only PV Power Load function is closed by default. If you need to use it, you need to open it by yourself.
2. Software: Ensure that the current DSP and HMI software is the latest version.

2. Solis APP Setting

Setting--Professional Setting--function Setting

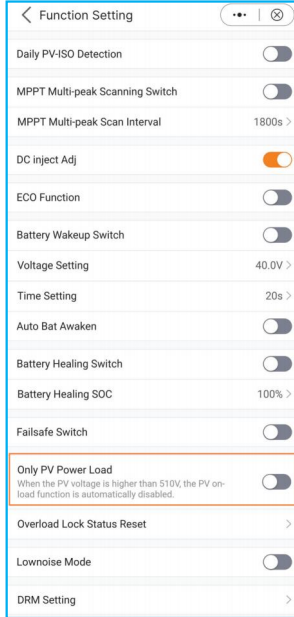

5.13 Heat pump setting

Setting--Professional Setting--Heat Pump Setting

Users can manually activate the normal and strengthen modes of the heat pump.

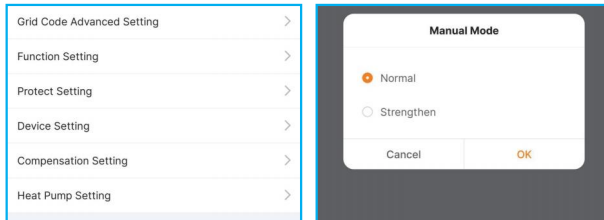

5.14 Dual meters setting

Hybrid inverter Setting--Professional Setting(password:1000)--Device setting-- Meter/CT Setting(meter)--Meter Type(meter)--Meter/CT Installation Location(Grid +PV Inverter)

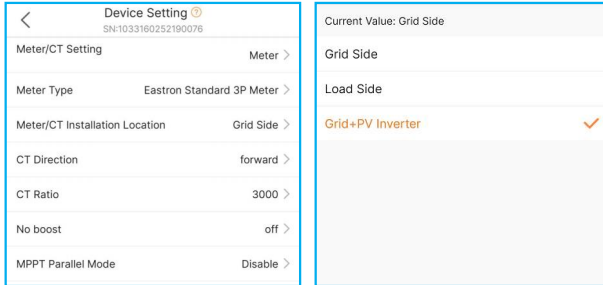

Meter setting

Meter setting password: 1000.

Meter1(grid)

Address: 001.

Meter2(PV inverter)

Address: 002.

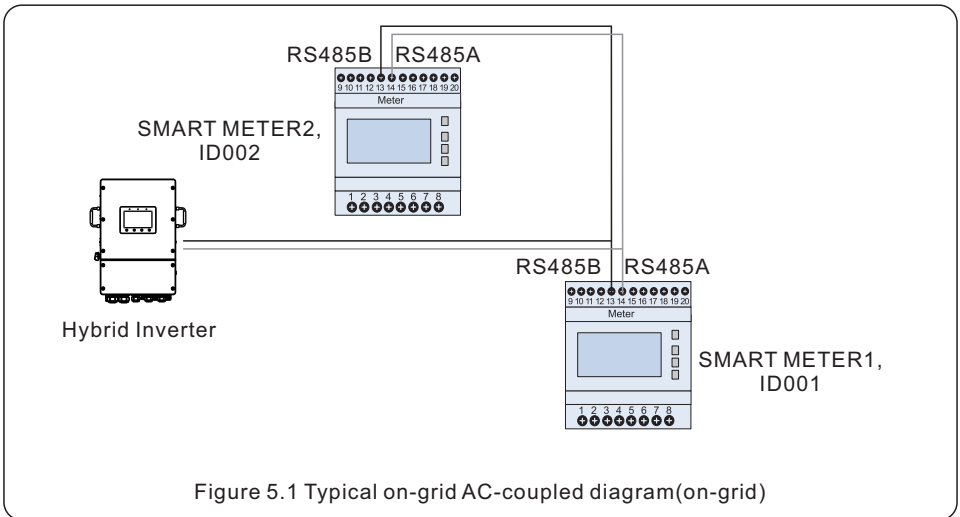

Figure 5.1 Typical on-grid AC-coupled diagram(on-grid)

5.15 HMI Screen Setting

5.15.1 HMI Quick Setting

If this is the first time the inverter has been commissioned, you will need to first go through the Quick Settings. Once this has been done, these settings can be changed later.

Inverter Time -> Meter Setting -> Grid Code -> Storage mode -> Battery Model

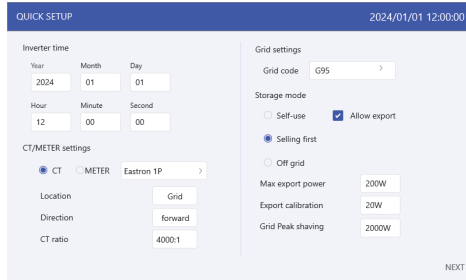

1. Inverter time:

Set inverter time and date, default follow the phone.

2. CT/Meter setting:

Select the CT or Meter, Solis provide Eastron 3 phase meter, it is self-identifiable.

Set installation location: Grid side / Load side / Grid+PV inverter;

CT direction: When CT installed correctly, select "Forward"; when CT installed direction wrong, the sampling current of CT will be reversed when calculating the power, select "Reversal" to correct it.

Set CT ratio: default 3000 (Solis provide 120A/40mA CT), if the user install their own CT, then need to set the CT ratio manually. If the system connected to Meter, then CT ratio need to be set on Meter.

3. Grid code:

Select grid code that meet the local regulations.

If the grid does not need to be connected to an N-Line, select disconnected.

4. Storage mode:

ALL modes first priority is to use the available PV power to support loads. The different modes determine what the second priority, or use of the excess PV power, will be.

Self-use / Selling first / Off-grid are exclusive, the user could select only one mode.

Mode	Description
Self-use	<p>Load priority: load>battery>grid Power supply priority: PV>battery>grid>DG This mode applies to the area that has low feed-in tariff and high energy price. The PV power will prioritize supplying energy to the load and charging the battery, with any surplus power being fed into the grid. During periods without PV power at night or when the PV power is insufficient, the battery will discharge to support the load.</p> <ul style="list-style-type: none"> •Supports TOU settings in this mode. •Supports Battery Reserve function in this mode.
Selling first	<p>Load priority: load>grid>battery Power supply priority: PV>battery>grid>DG This mode applies to the area that has high feed-in tariff and export control. The PV power will prioritize supplying energy to the load. Then any surplus is directed into the grid. If there is a feed-in limitation, the excess power will charge the battery.</p> <ul style="list-style-type: none"> •Supports TOU setting in this mode. •Supports Battery Reserve function in this mode.
Off grid	<p>Load priority : load>battery Power supply priority: PV>battery>DG</p> <ul style="list-style-type: none"> •This mode applies to the area not covered by the grid or when the system is not connected to the grid. •When a power outage is detected in a grid-tied system, the system will automatically will automatically enter in the off-grid, supplying only the backup load. •The user can also manually set this mode, supplying only the backup load.

Table 1 Description of modes

Under each mode, user could set other functions based on their requirements.

Settings	Description
Allow Export	<p>Allow power output to the grid in Self-use mode. If you do not want to send power to the grid, do not turn it on.</p>
Max export power	<p>Limit the maximum power sold to the grid.</p>
Export calibration	<p>Range : -500w-500w, default 20w, settable. To compensate the deviation of CT/Meter in practical application.</p>
Grid peak shaving	<p>Limit the power that inverters can obtain from the grid to prevent exceeding regulatory requirements or the power line capacity due to excessive power. When the grid supplies power to the load while charging the battery, it will limit the power used to charge the battery, so that the total power does not exceed the set value. If the grid only supplies power to the load and does not charging the battery, it is not limited by the setting value.</p>

Table 2 Description of mode settings

5. Battery setting:

Select battery brand.

Set Max charging/discharging current.

The screenshot displays the 'BATTERY SETTING' configuration screen. At the top, the title 'BATTERY SETTING' and the timestamp '2024/01/01 12:00:00' are visible. The interface is divided into two main sections. The left section, titled 'Batt type', contains a dropdown menu currently set to 'PYLON_HV' and a list of radio button options: 'Lithium Battery' (selected), '48.0V Lithium Battery (Without COMM)', '51.2V Lithium Battery (Without COMM)', 'Lead-acid Battery', and 'No Battery'. The right section contains several adjustable parameters, each with a corresponding input field: 'Max charge current' (100A), 'Max discharge current' (100A), 'Over discharge' (80%), 'Recovery' (80%), 'Force charge' (80%), and 'Max charge SOC' (80%). A 'Battery saving' checkbox is checked. A '1/2' indicator is located at the bottom right corner of the settings panel.

5.15.2 HMI screen operation system overview

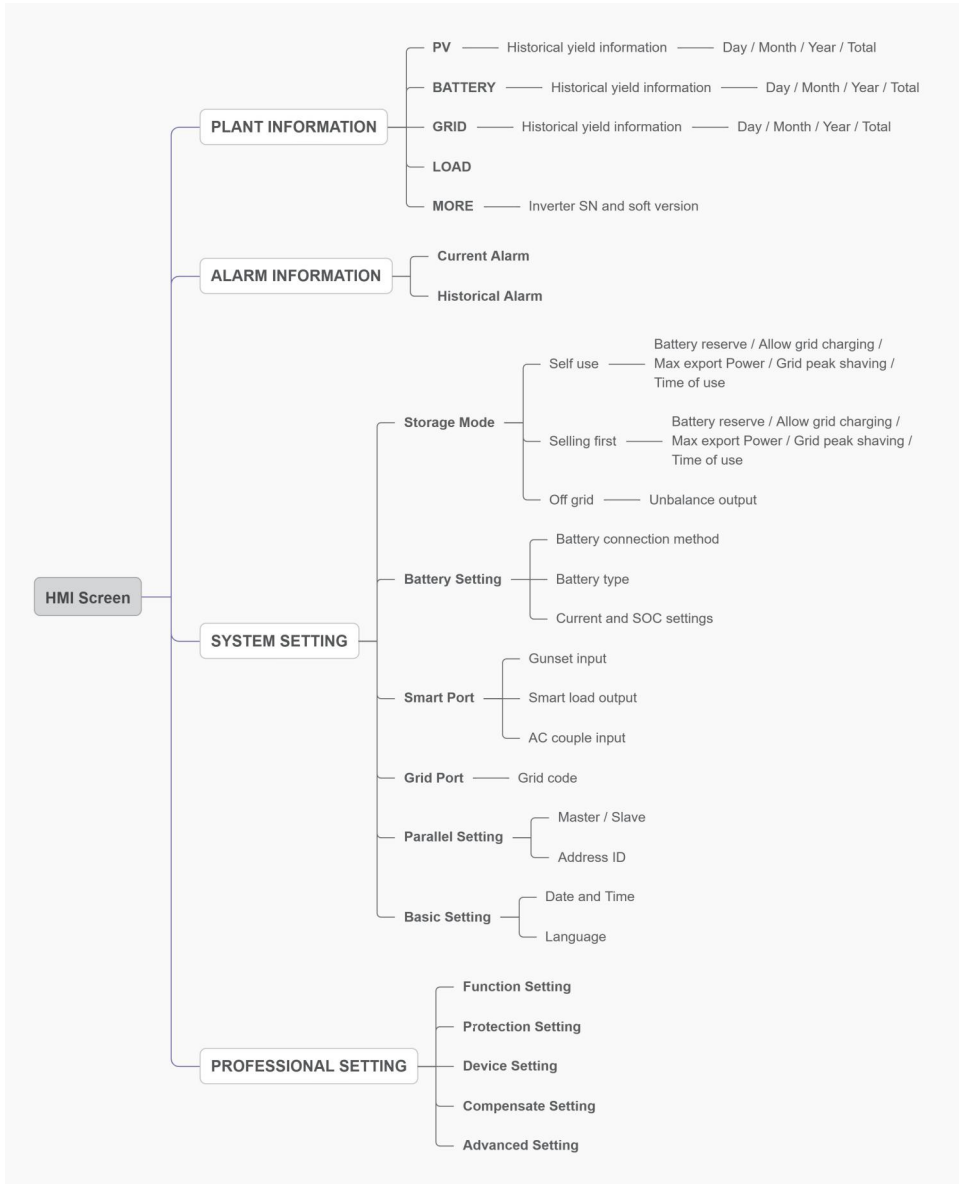

5.15.3 Detailed HMI Setting

Step 1: Enter Home page

After quick setting, press “ENTER”, the screen displays the home page.

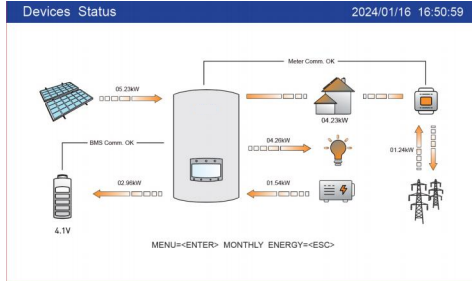

The screen will be automatically turn off after being idle for a few minutes to save power, click any operation button (“ESC”/“UP”/“DOWN”/“ENTER”) to restart the screen, then press “Enter” into the main operation interface.

Step 2: Enter “SYSTEM SETTING” interface

Press “Down” button, then press “ENTER” into the “SYSTEM SETTING” interface.

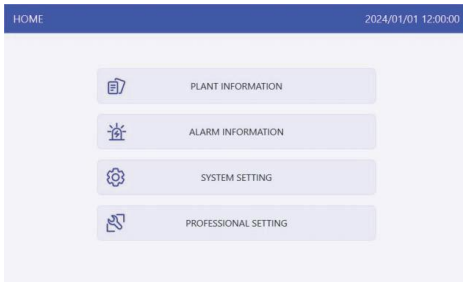

Step 3: Set “Storage Mode”

Use “UP” or “DOWN” key to select the desired mode, then press “ENTER”.
The Mode description please refer to 5.4.1.

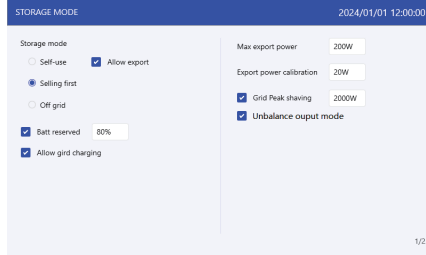

Settings	Description
Allow Export	Allow power output to the grid in Self-use mode. If you do not want to send power to the grid, do not turn it on.
Battery reserve	Range: 5~100%, default: 80%, settable. When battery SOC < set battery reserve SOC, battery will stop discharging. Only for on-grid.
Allow grid charging	Allow grid charging the battery when it enables. Notice: if “Allow Grid Charging” is turned on, the inverter will use grid power to charge the battery only under two circumstances: The battery drains to the Force Charge SOC. When PV power output can’t meet the set current value during the charge periods.
Max export power	Default: 1.1 times of rated power. Notice: if feed-in is not allowed, set Max export power to 0. Limit the maximum power sold to the grid.
Export calibration	Range : -500w-500w, default 20w, settable. To compensate the deviation of CT/Meter in practical application.
Grid peak shaving	Limit the power that inverters can obtain from the grid to prevent exceeding regulatory requirements or the power line capacity due to excessive power. When the grid supplies power to the load while charging the battery, it will limit the power used to charge the battery, so that the total power does not exceed the set value. If the grid only supplies power to the load and does not charging the battery, it is not limited by the setting value.
Unbalance output mode	Allow three-phase output imbalance, single-phase maximum load 50% of rated power. For example: 15kW inverter, single-phase maximum load 7.5kW; Balance output: three phase output is the same, for example: 15kW inverter, per phase output is 5kW.

Table 3 Description of storage mode settings



NOTE:

Solis's export power control function is based on the sampling results from the smart meter or smart CT. Due to the sampling interval limitation, when the system's load consumption has sudden changes, small amount of export overshooting is expected. For strict zero injection applications, it is suggested to install external backflow trip device as additional protection for injection.

Step 4: Set "Time of use" under each mode (Skip this step if no need)

Time of Use is for manual control of the battery charging/discharging. It is for customizing when the battery is allowed to charge and discharge power and at what rate, established by a current(amperage)setting.

1. Charge period: battery charges with set current value until the charging cut-off voltage (settable), checking the box to control whether enable this charging period.
2. Discharge period: battery discharges with set current value until the discharging cut-off voltage (settable), checking the box to control whether enable this discharging period.

STORAGE MODE					2024/01/01 12:00:00				
Charge period					Discharge period				
	Start	Stop	Current	SOC		Start	Stop	Current	SOC
<input checked="" type="checkbox"/>	01 : 00	- 05 : 00	100A	50%	<input checked="" type="checkbox"/>	01 : 00	- 05 : 00	100A	50%
<input type="checkbox"/>	01 : 00	- 05 : 00	100A	50%	<input type="checkbox"/>	01 : 00	- 05 : 00	100A	50%
<input checked="" type="checkbox"/>	01 : 00	- 05 : 00	100A	50%	<input checked="" type="checkbox"/>	01 : 00	- 05 : 00	100A	50%
<input type="checkbox"/>	01 : 00	- 05 : 00	100A	50%	<input type="checkbox"/>	01 : 00	- 05 : 00	100A	50%
<input checked="" type="checkbox"/>	01 : 00	- 05 : 00	100A	50%	<input checked="" type="checkbox"/>	01 : 00	- 05 : 00	100A	50%
<input type="checkbox"/>	01 : 00	- 05 : 00	100A	50%	<input type="checkbox"/>	01 : 00	- 05 : 00	100A	50%

2/2



NOTE:

The set current value is the maximum current for charging/discharging the battery. However, the actual charging and discharging current may not reach this value due to the influence of other factors, such as the maximum charging/ discharging power limitation of the inverter, the battery BMS limitation, etc.

Step 5: Set “Battery Setting”

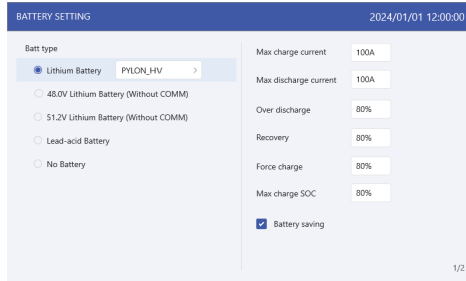

Settings	Description
Max charge current	Max charge current, settable.
Max discharge current	Max discharge current, settable.
Over discharge	The Overdischarge SOC (State of Charge) is the minimum battery charge level to which the inverter will discharge. It acts as a safeguard to prevent the battery from discharging beyond this specified threshold, ensuring its longevity and health.
Recovery	The battery can discharge when the SOC/Voltage reaches the set value.
Force charge	Range: 4%~ set Over discharge value when battery SOC < force charge SOC, the grid will charge the battery.
Max charge SOC	The battery can discharge when the SOC/Voltage reaches the set value.
Battery saving	Reduce battery loss. The necessary power for the operation of the inverter preferentially obtains from the grid, not from the battery.

Table 4 Description of battery mode settings



NOTICE:

Force charge SOC < Over discharge SOC < Recovery SOC, otherwise the setting might be error.



NOTE:

For lead-acid or non-communicated lithium batteries, Solis hybrid inverters are using measured battery voltage to estimate the battery's state of charge (SOC). Due to measurement accuracy and different batteries' behaviours, Solis's estimated battery SOC parameter is for reference only. Solis does NOT guarantee the accuracy for this parameter.

Step 6: Set “Grid Port”

(Skip this step if grid code is already set in quick setting)

Select grid code that meet the local regulations.

Three level of Over-voltage / under-voltage / Over-frequency / under-frequency are default based on grid code, there is no need to set the parameters in manual.

Step 7: Set “Smart Port”

(Skip this step if the system is not connected to generators)

When it is connected to Generator, select “Gunset input”;

When it is connected to smart load like heat pump, select “Smart load output”

When it is connected to Grid-tied inverter, select “AC coupled”

Step 8: Set parallel system

Set Master and Slave machine,

Set Master ID as: 1

Slave machine ID as: 2

.Slave machine ID as: 3

..... and so on.



Solis S6 Series inverter does not require any regular maintenance. However, cleaning the heatsink will help the inverter dissipate heat and increase the lifetime of inverter. The dirt on the inverter can be cleaned with a soft brush.



CAUTION:

Do not touch the surface when the inverter is operating. Some parts may be hot and could cause burns. Turn OFF the inverter and let it cool down before you do any maintenance or cleaning of inverter.

The Screen and the LED status indicator lights can be cleaned with cloth if they are too dirty to be read.



NOTE:

Never use any solvents, abrasives, or corrosive materials to clean the inverter.

6.1 Smart O&M

In order to improve our products and provide you with higher quality services, this device has a built-in data logging module for collecting relevant information during operation (such as power generation data, fault data)

Commitment:

1. We will only collect, use and process your device information for the purpose of improving our products and services.
2. We will take all reasonable and feasible measures to ensure that no irrelevant information is collected and we will protect your device information.
3. We will not share, transfer or disclose the collected device information with any company, organization or individual.
4. When we stop operating products or services, we will stop collecting your device information in a timely manner.
5. If you do not want to provide such information, you can notify our company to turn off this function, which will not affect your normal use of other functions of the product.

7. Troubleshooting

Message Name	Information Description	Troubleshooting Suggestion
Off	Control device to shutdown	1. Turn on the device in the ON/OFF Setting.
LmtByEPM	The device's output is under controlled	<ol style="list-style-type: none"> 1. Confirm whether the inverter is connected to an external EPM/meter to prevent reverse current. 2. Confirm whether the inverter is controlled by an external third-party device. 3. Confirm whether the power setting of the inverter power control is limited. 4. Verify settings in section 6.6.7 and check your meter readings.
LmtByDRM	DRM Function ON	1. No need to deal with it.
LmtByTemp	Over temperature power limited	1. No need to deal with it, the device is in normal operation.
LmtByFreq	Frequency power limited	
LmtByVg	The device is in the Volt-Watt mode	<ol style="list-style-type: none"> 1. Due to the requirements of local safety regulations, when the grid voltage is high, the Volt-watt working mode is triggered, which generally does not need to be dealt with. 2. Inverter factory test errors causing this mode to open, if you need to close, you can close this mode in LCD, set the process: Main menu → Advanced Settings → Password 0010 → STD mode settings → Working Mode → Working mode: NULL → Save and exit.
LmtByVar	The device is in the Volt-Var mode of operation	<ol style="list-style-type: none"> 1. Due to the requirements of local safety regulations, when the grid voltage is high, the Volt-watt working mode is triggered, which generally does not need to be dealt with. 2. Inverter factory test errors causing this mode to open, if you need to close, you can close this mode in LCD, set the process: Main menu → Advanced Settings → Password 0010 → STD mode settings → Working Mode → Working mode: NULL → Save and exit.
LmtByUnFr	Under frequency limit	1. No need to deal with it.
Standby	Bypass run	
StandbySynoch	Off grid status to On grid status	
GridToLoad	Grid to load	

Message Name	Information Description	Troubleshooting Suggestion
Surge Alarm	On-site grid surge	1. Grid side fault, restart the device. If it is still not eliminated, please contact the manufacturer's customer service.
OV-G-V01	Grid voltage exceeds the upper voltage range	1. Confirm whether the power grid is abnormal. 2. Confirm that the AC cable is properly connected. 3. Restart the system and check if the fault persists.
UN-G-V01	Grid voltage exceeds the lower voltage range	
OV-G-F01	Grid frequency exceeds the upper frequency range	
UN-G-F01	Grid frequency exceeds the lower frequency range	
G-PHASE	Unbalanced grid voltage	
G-F-GLU	Grid voltage frequency fluctuation	
NO-Grid	No grid	
OV-G-V02	Grid transient overvoltage	
OV-G-V03	Grid transient overvoltage	1. Restart the system, confirm if that the fault continues.
IGFOL-F	Grid current tracking failure	1. Confirm whether the power grid is abnormal. 2. Confirm that the AC cable is properly connected. 3. Restart the system and check if the fault persists.
OV-G-V05	Grid voltage RMS instantaneous overvoltage fault	
OV-G-V04	Grid voltage exceeds the upper voltage range	
UN-G-V02	Grid voltage exceeds the lower voltage range	
OV-G-F02	Grid frequency exceeds the upper frequency range	
UN-G-F02	Grid frequency exceeds the lower frequency range	
NO-Battery	Battery is not connected	1. Check on information page 1 – Verify the battery voltage is within standards. 2. Measure battery voltage at plug.
OV-Vbackup	Inverting overvoltage	1. Check whether the backup port wiring is normal 2. Restart the system, confirm that the fault continues.
Over-Load	Load overload fault	1. Backup load power is too large, or some inductive load startup power is too large, need to remove some backup load, or remove the inductive load on the backup.

Message Name	Information Description	Troubleshooting Suggestion
BatName-FAIL	Wrong battery brand selection	1. Confirm whether the battery model selection is consistent with the actual one.
CAN Fail	CAN Fail	1. Can failure is a failure of communication between inverter and battery. Check cable conditions. Check to ensure you have it plugged in on the CAN port of the battery and inverter. Check that you are using the right cable. Some batteries require a special battery from the battery manufacturer.
OV-Vbatt	Battery overvoltage detected	1. Verify battery voltage is within standards. Measure battery voltage at inverter connection point. Contact your battery manufacturer for further service.
UN-Vbatt	Battery undervoltage detected	1. Restart the system and check if the fault persists. If it is still not eliminated, please contact the manufacturer's customer service.
Fan Alarm	Fan alarm	1. Check if the internal fan is working correctly or jammed.
OV-DC01 (1020 DATA:0001)	DC 1 input overvoltage	1. Check if the PV voltage is abnormal 2. Restart the system, confirm that the fault continues
OV-DC02 (1020 DATA:0002)	DC 2 input overvoltage	
OV-BUS (1021 DATA:0000)	DC bus overvoltage	1. Restart the system, confirm that the fault continues.
UN-BUS01 (1023 DATA:0001)	DC bus undervoltage	
UNB-BUS (1022 DATA:0000)	DC bus unbalanced voltage	
UN-BUS02 (1023 DATA:0002)	Abnormal detection of DC bus voltage	
DC-INTF. (1027 DATA:0000)	DC hardware overcurrent (1, 2, 3, 4)	1. Check if the DC wires are connected correctly without loose connection.
OV-G-I (1018 DATA:0000)	Aphase RMS value overcurrent	1. Confirm that the grid is abnormal. 2. Confirm that the AC cable connection is not abnormal. 3. Restart the system, confirm that the fault continues.
OV-DCA-I (1025 DATA:0000)	DC 1 average overcurrent	1. Restart the system, confirm that the fault continues.
OV-DCB-I (1026 DATA:0000)	DC 2 average overcurrent	
GRID-INTF. (1030 DATA:0000)	AC hardware overcurrent (abc phase)	

7. Troubleshooting

Message Name	Information Description	Troubleshooting Suggestion
DCInj-FAULT (1037 DATA:0000)	The current DC component exceeds the limit	<ol style="list-style-type: none"> 1. Confirm that the grid is abnormal. 2. Confirm that the AC cable connection is not abnormal. 3. Restart the system, confirm that the fault continues.
IGBT-OV-I (1048 DATA:0000)	IGBT overcurrent	<ol style="list-style-type: none"> 1. Restart the system, confirm that the fault continues.
OV-TEM (1032 DATA:0000)	Module over temperature	<ol style="list-style-type: none"> 1. Check whether the surrounding environment of the inverter has poor heat dissipation. 2. Confirm whether the product installation meets the requirements.
RelayChk-FAIL (1035 DATA:0000)	Relay failure	<ol style="list-style-type: none"> 1. Restart the system, confirm that the fault continues.
UN-TEM (103A DATA:0000)	Low temperature protection	<ol style="list-style-type: none"> 1. Check the working environment temperature of the inverter. 2. Restart the system to confirm if the fault continues.
PV ISO-PRO01 (1033 DATA:0001)	PV negative ground fault	<ol style="list-style-type: none"> 1. Check whether the PV strings have insulation problems. 2. Check whether the PV cable is damaged.
PV ISO-PRO02 (1033 DATA:0002)	PV positive ground fault	
12Power-FAULT (1038 DATA:0000)	12V undervoltage failure	<ol style="list-style-type: none"> 1. Check current leakage to ground. Verify your grounding. Verify all wires are in good condition and not leaking current to ground.
ILeak-PRO01 (1034 DATA:0001)	Leakage current failure 01 (30mA)	
ILeak-PRO02 (1034 DATA:0002)	Leakage current failure 02 (60mA)	
ILeak-PRO03 (1034 DATA:0003)	Leakage current failure 03 (150mA)	
ILeak-PRO04 (1034 DATA:0004)	Leakage current failure 04	
ILeak_Check (1039 DATA:0000)	Leakage current sensor failure	
GRID-INTF02 (1046 DATA:0000)	Power grid disturbance 02	<ol style="list-style-type: none"> 1. Confirm whether the grid is seriously distorted. 2. Check whether the AC cable is connected reliably.
OV-Vbatt-H/ OV-BUS-H (1051 DATA:0000)	Battery overvoltage hardware failure / VBUS	<ol style="list-style-type: none"> 1. Check if the battery circuit breaker is tripping. 2. Check if the battery is damaged.

Message Name	Information Description	Troubleshooting Suggestion
OV-ILLC (1052 DATA:0000)	LLC hardware overcurrent	1. Check whether the backup load is overloaded. 2. Restart the system, confirm that the fault continues.
INI-FAULT (1031 DATA:0000)	AD zero drift overlink	1. Restart the system, confirm that the fault continues.
DSP-B-FAULT (1036 DATA:0000)	The master-slave DSP communication is abnormal	
AFCI-Check (1040 DATA:0000)	AFCI self-test failure	
ARC- FAULT (1041 DATA:0000)	AFCI failure	1. Verify connections are tight within your PV system. Arc fault settings can be changed in advanced settings if further adjustment is necessary.

Table 7.1 Fault message and description



NOTE:

If the inverter displays any alarm message as listed in Table 7.1; please turn off the inverter and wait for 5 minutes before restarting it .
If the failure persists, please contact your local distributor or the service center.

Please keep ready with you the following information before contacting us.

1. Serial number of Solis Singles Phase Inverter;
2. The distributor/dealer of Solis Singles Phase Inverter (if available);
3. Installation date.
4. The description of the problem together with necessary information, pictures, attachment.
5. The PV array configuration (e.g. number of panels, capacity of panels, number of strings, etc.);
6. Your contact details.

8. Specifications

Technical Data	S6-EH3P8K02-NV-YD-L	S6-EH3P10K02-NV-YD-L
Input DC (PV side)		
Recommended max PV array size	16kW	20kW
Max Usable PV Input Power	12.8kW	16kW
Max. input voltage	1000V	
Rated voltage	550V	
Start-up voltage	160V	
MPPT voltage range	200-850V	
Max. input current	20A/40A	
Max. short circuit current	30A/50A	
MPPT number/Max input strings number	2/3	
Battery		
Battery Type	Li-ion/Lead-acid	
Battery Voltage range	40-60V	
Max. charge / discharge current	180A	220A
Number of battery port	2	
Maximum charge / discharge current of each port	150A	
Communication	CAN/RS485	
Output AC(Grid side)		
Rated output power	8kW	10kW
Max. apparent output power	8kVA	10kVA
Rated grid voltage	3/N/PE, 220V/380V 3/N/PE, 230V/400V	
Rated grid frequency	50Hz/60Hz	
Rated grid output current	12.2A/11.5A	15.2A/14.4A
Power Factor	> 0.99 (0.8 leading - 0.8 lagging)	
THDi	<3%	
Input AC (Grid side)		
Max. input current	18.3A/17.3A	22.8A/21.7A

8. Specifications

Technical Data	S6-EH3P8K02-NV-YD-L	S6-EH3P10K02-NV-YD-L
Input AC (Generator)		
Max. input power	8kW	10kW
Max. input current	12.2A/11.5A	15.2A/14.4A
Rated input voltage	3/N/PE, 220V/380V 3/N/PE, 230V/400V	
Rated input frequency	50Hz/60Hz	
Output AC(Back-up)		
Rated output power	8kW	10kW
Max. apparent output power	2 times of rated power, 10 S	
Back-up switch time	< 10ms	
Rated output voltage	3/N/PE, 220V/380V 3/N/PE, 230V/400V	
Rated frequency	50 Hz/60 Hz	
Rated output current	12.2A/11.5A	15.2A/14.4A
Max. Continuous output current	12.2A/11.5A	15.2A/14.4A
Max. Continuous AC Passthrough current	50A	
THDv(@linear load)	<3%	
Efficiency		
Max. efficiency	97.5%	
EU efficiency	97.0%	
BAT charged by PV Max. efficiency	95.0%/94.4%	
BAT charged/discharged to AC Max. efficiency	94.5%	
Protection		
Anti-islanding protection	Yes	
Insulation Resistor detection	Yes	
Output over current protection	Yes	
Output short protection	Yes	
Output over voltage protection	Yes	
DC reverse polarity protection	Yes	
Surge Protection	DC Type II / AC Type II (Optional)	
Protection class / Over voltage category	I / II (PV and BAT), III (MAINS and BACKUP and GEN)	
Integrated AFCI 2.0	Optional	
Residual current detection	Yes	
Integrated PV switch	Yes	

8. Specifications

Technical Data	S6-EH3P8K02-NV-YD-L	S6-EH3P10K02-NV-YD-L
General data		
Max. power per phase	50% rated power	
Dimensions(W/H/D)	430*660*305mm	
Weight	≤42KG	
Topology	Non-isolated	
Self consumption (Night)	<30W	
Operation temperature range	-40°C ~ +60°C	
Relative humidity	0-100%	
Ingress protection	IP66	
Noise emission	<65 dB(A)	
Cooling concept	Smart Fan Cooling	
Max.operation altitude	4000m	
Grid connection standard	NRS 097-2-1, IEC 62116, IEC 61727, IEC 60068, IEC 61683, EN 50530, SriLanka, EN 50438L, Vietnam, MEA, PEA, CEI 0-21	
Safty/EMC standard	IEC/EN 62109-1/-2, IEC/EN 61000-6-1/-2/-3/-4	
Features		
PV connection	MC4 Quick connection plug(PV)& Screw terminal(Battery)	
AC connection	Screw terminal	
Display	LCD + Bluetooth + APP	
Communication	CAN, RS485, Ethernet, Optional:Wi-Fi, Cellular, LAN	
Warranty	5 years (Extend to 20 years)	

8. Specifications

Technical Data	S6-EH3P12K02-NV-YD-L
Input DC (PV side)	
Recommended max PV array size	24kW
Max Usable PV Input Power	19.2kW
Max. input voltage	1000V
Rated voltage	550V
Start-up voltage	160V
MPPT voltage range	200-850V
Max. input current	20A/40A
Max. short circuit current	30A/50A
MPPT number/Max input strings number	2/3
Battery	
Battery Type	Li-ion/Lead-acid
Battery Voltage range	40-60V
Max. charge / discharge current	250A
Number of battery port	2
Maximum charge / discharge current of each port	150A
Communication	CAN/RS485
Output AC(Grid side)	
Rated output power	12kW
Max. apparent output power	12kVA
Rated grid voltage	3/N/PE, 220V/380V 3/N/PE, 230V/400V
Rated grid frequency	50Hz/60Hz
Rated grid output current	18.2A/17.3A
Power Factor	>0.99 (0.8 leading - 0.8 lagging)
THDi	<3%
Input AC (Grid side)	
Max. input current	27.3A/26.0A

8. Specifications

Technical Data	S6-EH3P12K02-NV-YD-L
Input AC (Generator)	
Max. input power	12kW
Max. input current	18.2A/17.3A
Rated input voltage	3/N/PE, 220V/380V 3/N/PE, 230V/400V
Rated input frequency	50Hz/60Hz
Output AC(Back-up)	
Rated output power	12kW
Max. apparent output power	2 times of rated power, 10 S
Back-up switch time	< 10ms
Rated output voltage	3/N/PE, 220V/380V 3/N/PE, 230V/400V
Rated frequency	50 Hz/60 Hz
Rated output current	18.2A/17.3A
Max. Continuous output current	18.2A/17.3A
Max. Continuous AC Passthrough current	50A
THDv(@linear load)	<3%
Efficiency	
Max. efficiency	97.5%
EU efficiency	97.0%
BAT charged by PV Max. efficiency	95.0%/94.4%
BAT charged/discharged to AC Max. efficiency	94.5%
Protection	
Anti-islanding protection	Yes
Insulation Resistor detection	Yes
Output over current protection	Yes
Output short protection	Yes
Output over voltage protection	Yes
DC reverse polarity protection	Yes
Surge Protection	DC Type II / AC Type II (Optional)
Protection class / Over voltage category	I / II (PV and BAT), III (MAINS and BACKUP and GEN)
Integrated AFCI 2.0	Optional
Residual current detection	Yes
Integrated PV switch	Yes

8. Specifications

Technical Data	S6-EH3P12K02-NV-YD-L
General data	
Max. power per phase	50% rated power
Dimensions(W/H/D)	430*660*305mm
Weight	≤42KG
Topology	Non-isolated
Self consumption (Night)	<30W
Operation temperature range	-40°C ~ +60°C
Relative humidity	0-100%
Ingress protection	IP66
Noise emission	<65 dB(A)
Cooling concept	Smart Fan Cooling
Max.operation altitude	4000m
Grid connection standard	NRS 097-2-1, IEC 62116, IEC 61727, IEC 60068, IEC 61683, EN 50530, SriLanka, EN 50438L, Vietnam, MEA, PEA, CEI 0-21
Safty/EMC standard	IEC/EN 62109-1/-2, IEC/EN 61000-6-1/-2/-3/-4
Features	
PV connection	MC4 Quick connection plug(PV)& Screw terminal(Battery)
AC connection	Screw terminal
Display	LCD + Bluetooth + APP
Communication	CAN, RS485, Ethernet, Optional:Wi-Fi, Cellular, LAN
Warranty	5 years (Extend to 20 years)

8. Specifications

Technical Data	S6-EH3P15K02-NV-YD-L	S6-EH3P18K02-NV-YD-L
Input DC (PV side)		
Recommended max PV array size	30kW	36kW
Max Usable PV Input Power	24kW	28.8kW
Max. input voltage	1000V	
Rated voltage	550V	
Start-up voltage	160V	
MPPT voltage range	200-850V	
Max. input current	40A/40A	42A/42A
Max. short circuit current	50A/50A	
MPPT number/Max input strings number	2/4	
Battery		
Battery Type	Li-ion/Lead-acid	
Battery Voltage range	40-60V	
Max. charge / discharge current	290A	320A
Number of battery port	2	
Maximum charge / discharge current of each port	150A	175A
Communication	CAN/RS485	
Output AC(Grid side)		
Rated output power	15kW	18kW
Max. apparent output power	15kVA	18kVA
Rated grid voltage	3/N/PE, 220V/380V 3/N/PE, 230V/400V	
Rated grid frequency	50Hz/60Hz	
Rated grid output current	22.8A/21.7A	27.3A/26.1A
Power Factor	>0.99 (0.8 leading - 0.8 lagging)	
THDi	<3%	
Input AC (Grid side)		
Max. input current	34.2A/32.5A	41.0A/39.2A

8. Specifications

Technical Data	S6-EH3P15K02-NV-YD-L	S6-EH3P18K02-NV-YD-L
Input AC (Generator)		
Max. input power	15kW	18kW
Max. input current	22.8A/21.7A	27.3A/26.1A
Rated input voltage	3/N/PE, 220V/380V 3/N/PE, 230V/400V	
Rated input frequency	50Hz/60Hz	
Output AC(Back-up)		
Rated output power	15kW	18kW
Max. apparent output power	2 times of rated power, 10 S	
Back-up switch time	< 10ms	
Rated output voltage	3/N/PE, 220V/380V 3/N/PE, 230V/400V	
Rated frequency	50 Hz/60 Hz	
Rated output current	22.8A/21.7A	27.3A/26.1A
Max. Continuous output current	22.8A/21.7A	27.3A/26.1A
Max. Continuous AC Passthrough current	50A	
THDv(@linear load)	<3%	
Efficiency		
Max. efficiency	97.5%	
EU efficiency	97.0%	
BAT charged by PV Max. efficiency	95.0%/94.4%	
BAT charged/discharged to AC Max. efficiency	94.5%	
Protection		
Anti-islanding protection	Yes	
Insulation Resistor detection	Yes	
Output over current protection	Yes	
Output short protection	Yes	
Output over voltage protection	Yes	
DC reverse polarity protection	Yes	
Surge Protection	DC Type II / AC Type II (Optional)	
Protection class / Over voltage category	I / II (PV and BAT), III (MAINS and BACKUP and GEN)	
Integrated AFCI 2.0	Optional	
Residual current detection	Yes	
Integrated PV switch	Yes	

8. Specifications

Technical Data	S6-EH3P15K02-NV-YD-L	S6-EH3P18K02-NV-YD-L
General data		
Max. power per phase	50% rated power	40% rated power
Dimensions(W/H/D)	430*660*305mm	
Weight	≤42KG	
Topology	Non-isolated	
Self consumption (Night)	<30W	
Operation temperature range	-40°C ~ +60°C	
Relative humidity	0-100%	
Ingress protection	IP66	
Noise emission	<65 dB(A)	
Cooling concept	Smart Fan Cooling	
Max.operation altitude	4000m	
Grid connection standard	NRS 097-2-1, IEC 62116, IEC 61727, IEC 60068, IEC 61683, EN 50530, SriLanka, EN 50438L, Vietnam, MEA, PEA, CEI 0-21	
Safty/EMC standard	IEC/EN 62109-1/-2, IEC/EN 61000-6-1/-2/-3/-4	
Features		
PV connection	MC4 Quick connection plug(PV)& Screw terminal(Battery)	
AC connection	Screw terminal	
Display	LCD + Bluetooth + APP	
Communication	CAN, RS485, Ethernet, Optional:Wi-Fi, Cellular, LAN	
Warranty	5 years (Extend to 20 years)	

8. Specifications

Technical Data	S6-EH3P7K02-LV-YD-L	S6-EH3P8K02-LV-YD-L
Input DC (PV side)		
Recommended max PV array size	14kW	16kW
Max Usable PV Input Power	11.2kW	12.8kW
Max. input voltage	1000V	
Rated voltage	550V	
Start-up voltage	160V	
MPPT voltage range	200-850V	
Max. input current	20A/40A	
Max. short circuit current	30A/50A	
MPPT number/Max input strings number	2/3	
Battery		
Battery Type	Li-ion/Lead-acid	
Battery Voltage range	40-60V	
Max. charge / discharge current	156A	178A
Number of battery port	2	
Maximum charge / discharge current of each port	150A	
Communication	CAN/RS485	
Output AC(Grid side)		
Rated output power	7kW	8kW
Max. apparent output power	7kVA	8kVA
Rated grid voltage	3/N/PE, 127V/220V 3/N/PE, 133V/230V	
Rated grid frequency	50Hz/60Hz	
Rated grid output current	18.4A/17.6A	21.0A/20.1A
Power Factor	> 0.99 (0.8 leading - 0.8 lagging)	
THDi	<3%	
Input AC (Grid side)		
Max. input current	27.6A	31.5A

8. Specifications

Technical Data	S6-EH3P7K02-LV-YD-L	S6-EH3P8K02-LV-YD-L
Input AC (Generator)		
Max. input power	7kW	8kW
Max. input current	18.4A/17.6A	21.0A/20.1A
Rated input voltage	3/N/PE, 127V/220V 3/N/PE, 133V/230V	
Rated input frequency	50Hz/60Hz	
Output AC(Back-up)		
Rated output power	7kW	8kW
Max. apparent output power	2 times of rated power, 10 S	
Back-up switch time	< 10ms	
Rated output voltage	3/N/PE, 127V/220V 3/N/PE, 133V/230V	
Rated frequency	50 Hz/60 Hz	
Rated output current	18.4A/17.6A	21.0A/20.1A
Max. Continuous output current	18.4A	21.0A
Max. Continuous AC Passthrough current	50A	
THDv(@linear load)	<3%	
Efficiency		
Max. efficiency	96.2%	
EU efficiency	95.4%	
BAT charged by PV Max. efficiency	95.0%/94.4%	
BAT charged/discharged to AC Max. efficiency	94.5%	
Protection		
Anti-islanding protection	Yes	
Insulation Resistor detection	Yes	
Output over current protection	Yes	
Output short protection	Yes	
Output over voltage protection	Yes	
DC reverse polarity protection	Yes	
Surge Protection	DC Type II / AC Type II (Optional)	
Protection class / Over voltage category	I / II (PV and BAT), III (MAINS and BACKUP and GEN)	
Integrated AFCI 2.0	Optional	
Residual current detection	Yes	
Integrated PV switch	Yes	

8. Specifications

Technical Data	S6-EH3P7K02-LV-YD-L	S6-EH3P8K02-LV-YD-L
General data		
Max. power per phase	50% rated power	
Dimensions(W/H/D)	430*660*305mm	
Weight	≤42KG	
Topology	Non-isolated	
Self consumption (Night)	<30W	
Operation temperature range	-25°C ~ +60°C	
Relative humidity	0-100%	
Ingress protection	IP66	
Noise emission	<65 dB(A)	
Cooling concept	Smart Fan Cooling	
Max.operation altitude	4000m	
Grid connection standard	Philippin	
Safty/EMC standard	IEC/EN 62109-1/-2, IEC/EN 61000-6-1/-2/-3/-4	
Features		
PV connection	MC4 Quick connection plug(PV)& Screw terminal(Battery)	
AC connection	Screw terminal	
Display	LCD + Bluetooth + APP	
Communication	CAN, RS485, Ethernet, Optional:Wi-Fi, Cellular, LAN	
Warranty	5 years (Extend to 20 years)	

8. Specifications

Technical Data	S6-EH3P9K02-LV-YD-L	S6-EH3P10K02-LV-YD-L
Input DC (PV side)		
Recommended max PV array size	18kW	20kW
Max Usable PV Input Power	14.4kW	16kW
Max. input voltage	1000V	
Rated voltage	550V	
Start-up voltage	160V	
MPPT voltage range	200-850V	
Max. input current	20A/40A	21A/42A
Max. short circuit current	30A/50A	
MPPT number/Max input strings number	2/3	
Battery		
Battery Type	Li-ion/Lead-acid	
Battery Voltage range	40-60V	
Max. charge / discharge current	200A	235A
Number of battery port	2	
Maximum charge / discharge current of each port	150A	
Communication	CAN/RS485	
Output AC(Grid side)		
Rated output power	9kW	10kW
Max. apparent output power	9kVA	10kVA
Rated grid voltage	3/N/PE, 127V/220V 3/N/PE, 133V/230V	
Rated grid frequency	50Hz/60Hz	
Rated grid output current	23.5A/22.6A	26.3A/25.1A
Power Factor	> 0.99 (0.8 leading - 0.8 lagging)	
THDi	<3%	
Input AC (Grid side)		
Max. input current	35.4A	39.4A

8. Specifications

Technical Data	S6-EH3P9K02-LV-YD-L	S6-EH3P10K02-LV-YD-L
Input AC (Generator)		
Max. input power	9kW	10kW
Max. input current	23.5A/22.6A	26.3A/25.1A
Rated input voltage	3/N/PE, 127V/220V 3/N/PE, 133V/230V	
Rated input frequency	50Hz/60Hz	
Output AC(Back-up)		
Rated output power	9kW	10kW
Max. apparent output power	2 times of rated power, 10 S	
Back-up switch time	< 10ms	
Rated output voltage	3/N/PE, 127V/220V 3/N/PE, 133V/230V	
Rated frequency	50 Hz/60 Hz	
Rated output current	23.5A/22.6A	26.3A/25.1A
Max. Continuous output current	23.5A	26.3A
Max. Continuous AC Passthrough current	50A	
THDv(@linear load)	<3%	
Efficiency		
Max. efficiency	96.2%	
EU efficiency	95.4%	
BAT charged by PV Max. efficiency	95.0%/94.4%	
BAT charged/discharged to AC Max. efficiency	94.5%	
Protection		
Anti-islanding protection	Yes	
Insulation Resistor detection	Yes	
Output over current protection	Yes	
Output short protection	Yes	
Output over voltage protection	Yes	
DC reverse polarity protection	Yes	
Surge Protection	DC Type II / AC Type II (Optional)	
Protection class / Over voltage category	I / II (PV and BAT), III (MAINS and BACKUP and GEN)	
Integrated AFCI 2.0	Optional	
Residual current detection	Yes	
Integrated PV switch	Yes	

8. Specifications

Technical Data	S6-EH3P9K02-LV-YD-L	S6-EH3P10K02-LV-YD-L
General data		
Max. power per phase	50% rated power	40% rated power
Dimensions(W/H/D)	430*660*305mm	
Weight	≤42KG	
Topology	Non-isolated	
Self consumption (Night)	<30W	
Operation temperature range	-25°C ~ +60°C	
Relative humidity	0-100%	
Ingress protection	IP66	
Noise emission	<65 dB(A)	
Cooling concept	Smart Fan Cooling	
Max.operation altitude	4000m	
Grid connection standard	Philippin	
Safty/EMC standard	IEC/EN 62109-1/-2, IEC/EN 61000-6-1/-2/-3/-4	
Features		
PV connection	MC4 Quick connection plug(PV)& Screw terminal(Battery)	
AC connection	Screw terminal	
Display	LCD + Bluetooth + APP	
Communication	CAN, RS485, Ethernet, Optional:Wi-Fi, Cellular, LAN	
Warranty	5 years (Extend to 20 years)	

Frequently Asked Questions

Q1: Why I have "CAN Fail" Alarm on the inverter?

A: "CAN Fail" indicates the CAN communication between inverter and battery is lost. Please double check if your CAN cable is correctly connected and if your battery is power on.

Q2: Why I have "BATName-Fail" Alarm on the inverter ?

A: Please check in the "Battery Setting->Battery Model" setting and confirm you selected the correct battery option as the nameplate of your battery module.

Q3: Why I have "MET-SLT-Fail" Alarm on the inverter?

A: Please check in the "Meter Setting->Meter Type" setting and confirm you selected the correct meter option corresponding to your smart meter.

Q4: Why the power values on the screen are fluctuating very fast?

A: If your loads are changing drastically, the inverter will adjust its power accordingly. If you confirm the loads are stable while the inverter power is changing very fast, please double check your meter CT's direction and make sure the arrow is towards grid.

Q5: Why I have "OV-ILLC" Alarm on the inverter ?

A: OV-ILLC indicates there is an overcurrent issue on the internal LLC circuit. It could be transient status during extreme condition such as overload. If it happens constantly or too frequent and the extreme conditions have been excluded, please contact Solis service team.

Q6: Why I have "OV-BATT-H" Alarm on the inverter ?

A: OV-BATT-H indicates over voltage issue on the hardware of battery circuit. It could be caused by high battery voltage at full SOC, battery suddenly switching off, etc. If it happens constantly or too frequent and the extreme conditions have been excluded, please contact Solis service team.

Q7: Why I have "No-Battery" Alarm on the inverter?

A: Please double check if the battery power cables have been correctly connected and the battery breaker (on battery or external) has been turn on. If you don't want to connect the battery for now, please select the "No battery" option in "Battery Setting->Battery Model" to prevent the alarm to show up.

Ginlong Technologies Co., Ltd.

No. 57 Jintong Road, Binhai Industrial Park, Xiangshan, Ningbo,
Zhejiang, 315712, P.R.China.

Tel: +86 (0)574 6578 1806

Email: info@ginlong.com

Web: www.solisinverters.com

Please adhere to the actual products in case of any discrepancies in this user manual.

If you encounter any problem on the inverter, please find out the inverter S/N and contact us, we will try to respond to your question ASAP.