

Data Sheet | Item Number: 261-429/331-000

2-conductor terminal strip; on one side with push-buttons; with fixing flanges; 9-pole; for screw or similar mounting types; Fixing hole 3.2 mm Ø; 2.5 mm²; CAGE CLAMP®; gray

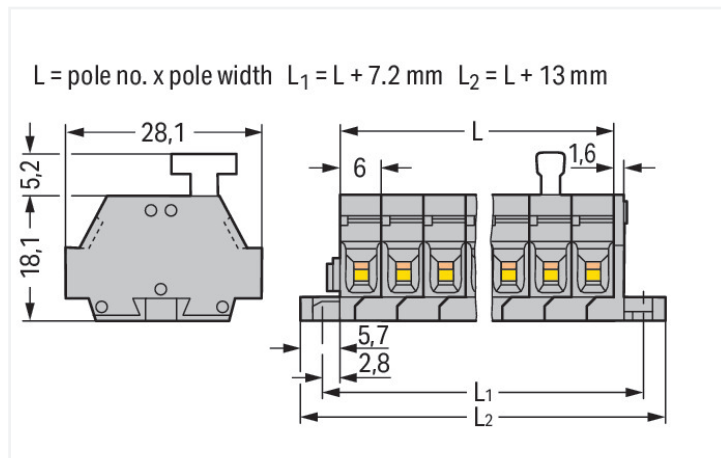

<https://www.wago.com/261-429/331-000>

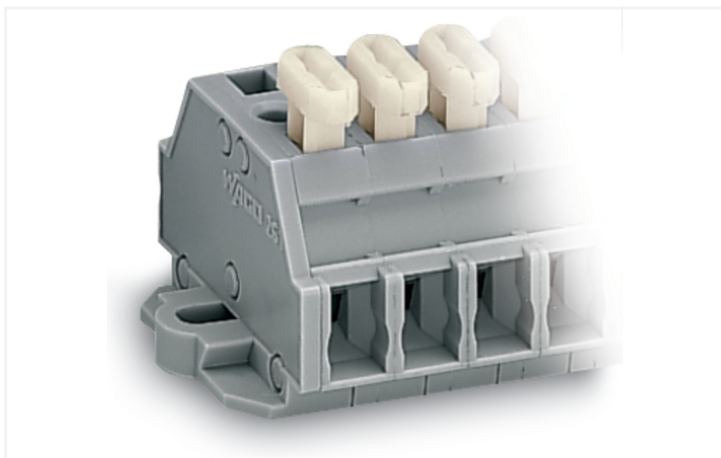

Color: ■ gray

Similar to illustration

Dimensions in mm

Through terminal block, 261 Series, operating tool

Quick and easy connections are guaranteed with this through terminal block (item number 261-429/331-000). Conductors can only be connected to this through terminal block if their strip length is between 8 and 9 mm. Whether in industrial or building applications, our rail-mount through terminal blocks are the perfect solution to quickly and securely connect electrical conductors. Depending on the model, you can use them for either typical through-wiring or potential distribution. This product features conductor terminals and utilizes CAGE CLAMP®. Our CAGE CLAMP® connection provides a reliable and maintenance-free way to connect all types of conductors. You do not need to prepare the conductor in any way, such as crimping ferrules. Dimensions: (67 x 28.1 x 23.3) mm (width x height x depth). This through terminal block is suitable for conductor cross sections ranging from 0.08 mm² to 2.5 mm².

Operating tool, push-button is used to operate this mini rail-mount terminal block.

Electrical data

Ratings per IEC/EN

| | |
|---|---|
| Nominal voltage (III/3) | 500 V |
| Rated impulse withstand voltage (III / 3) | 6 kV |
| Rated current | 24 A |
| Legend (ratings) | (III / 3) ≙ Overvoltage category III / Pollution degree 3 |

Approvals per

UL 1059

| Use group | B | C | D |
|---------------|-------|-------|-------|
| Rated voltage | 300 V | 300 V | 600 V |
| Rated current | 15 A | 15 A | 5 A |

Approvals per

CSA 22.2 No 158

| Use group | B | C | D |
|---------------|---|-------|-------|
| Rated voltage | - | 300 V | 600 V |
| Rated current | - | 10 A | 5 A |

General information

Wiring direction Side-entry wiring

Connection Data

| | |
|----------------------------|----|
| Clamping units | 18 |
| Total number of potentials | 9 |
| Number of levels | 1 |

Connection 1

| | |
|---------------------------------|-----------------------------------|
| Connection technology | CAGE CLAMP® |
| Actuation type | Operating tool |
| Connectable conductor materials | Copper |
| Solid conductor | 0.08 ... 2.5 mm² / 28 ... 14 AWG |
| Fine-stranded conductor | 0.08 ... 2.5 mm² / 28 ... 14 AWG |
| Strip length | 8 ... 9 mm / 0.31 ... 0.35 inches |
| Pole number | 9 |
| Wiring direction | Side-entry wiring |

Connection 2

| | |
|----------------|-------------|
| Actuation type | Push-button |
|----------------|-------------|

Physical data

| | |
|--------------|------------------------|
| Width | 67 mm / 2.638 inches |
| Height | 28.1 mm / 1.106 inches |
| Depth | 23.3 mm / 0.917 inches |
| Module width | 6 mm / 0.236 inches |

Mechanical data

| | |
|---------------|-----------------|
| Design | horizontal type |
| Mounting type | Mounting flange |
| Marking level | Side marking |

Material data

| | |
|------------------------------------|--|
| Note (material data) | Information on material specifications can be found here |
| Color | gray |
| Material group | I |
| Insulation material (main housing) | Polyamide (PA66) |
| Flammability class per UL94 | V0 |
| Fire load | 0.138 MJ |
| Halogen-free | Yes |
| Weight | 24.1 g |

Commercial data

| | |
|-----------------------|---------------|
| PU (SPU) | 50 pcs |
| Packaging type | Box |
| Country of origin | DE |
| GTIN | 4044918626910 |
| Customs tariff number | 85369010000 |

| Product Classification | |
|------------------------|----------------------|
| UNSPSC | 39121410 |
| eCl@ss 10.0 | 27-14-11-06 |
| eCl@ss 9.0 | 27-14-11-06 |
| ETIM 9.0 | EC001284 |
| ETIM 10.0 | EC001284 |
| ECCN | NO US CLASSIFICATION |

| Environmental Product Compliance | |
|----------------------------------|-------------------------|
| RoHS Compliance Status | Compliant, No Exemption |

Downloads

Environmental Product Compliance

| Compliance Search | |
|---|-------------------|
| Environmental Product Compliance 261-429/331-000 | ↓ |

Documentation

| Bid Text | | | |
|-----------------|------------|-----------------|-------------------|
| 261-429/331-000 | 19.02.2019 | xml 3.17 KB | ↓ |
| 261-429/331-000 | 17.08.2017 | doc 24.50 KB | ↓ |

CAD/CAE-Data

| CAD data | |
|---------------------------------|-------------------|
| 2D/3D Models 261-429/331-000 | ↓ |

| CAE data | |
|--------------------------------------|-------------------|
| EPLAN Data Portal 261-429/331-000 | ↓ |
| WSCAD Universe 261-429/331-000 | ↓ |
| ZUKEN Portal 261-429/331-000 | ↓ |

1 Compatible Products

1.1 Optional Accessories

1.1.1 Ferrule

1.1.1.1 Ferrule



Item No.: 216-301

Ferrule; Sleeve for 0.25 mm² / AWG 24; insulated; electro-tin plated; yellow



Item No.: 216-302

Ferrule; Sleeve for 0.34 mm² / 22 AWG; insulated; electro-tin plated; light turquoise



Item No.: 216-201

Ferrule; Sleeve for 0.5 mm² / 20 AWG; insulated; electro-tin plated; electrolytic copper; acc. to DIN 46228, Part 4/09.90; white



Item No.: 216-101

Ferrule; Sleeve for 0.5 mm² / AWG 22; un-insulated; electro-tin plated; silver-colored



Item No.: 216-202

Ferrule; Sleeve for 0.75 mm² / 18 AWG; insulated; electro-tin plated; gray



Item No.: 216-102

Ferrule; Sleeve for 0.75 mm² / AWG 20; un-insulated; electro-tin plated; silver-colored



Item No.: 216-203

Ferrule; Sleeve for 1 mm² / AWG 18; insulated; electro-tin plated; red



Item No.: 216-103

Ferrule; Sleeve for 1 mm² / AWG 18; un-insulated; electro-tin plated



Item No.: 216-204

Ferrule; Sleeve for 1.5 mm² / AWG 16; insulated; electro-tin plated; black



Item No.: 216-104

Ferrule; Sleeve for 1.5 mm² / AWG 16; un-insulated; electro-tin plated; silver-colored



Item No.: 216-205

Ferrule; Sleeve for 2.08 mm² / AWG 14; insulated; electro-tin plated; yellow



Item No.: 216-206

Ferrule; Sleeve for 2.5 mm² / AWG 14; insulated; electro-tin plated; blue



Item No.: 216-106

Ferrule; Sleeve for 2.5 mm² / AWG 14; un-insulated; electro-tin plated; silver-colored

1.1.2 Installation

1.1.2.1 Mounting accessories



Item No.: 209-137

Mounting adapter; can be used as end stop; 6.5 mm wide; gray



Item No.: 209-123

Mounting foot with screw; can be screwed on terminal blocks with fixing flange; 6.4 mm wide; gray

1.1.3 Jumper

1.1.3.1 Jumper



Item No.: 261-402

Jumper; for conductor entry; 2-way; insulated; gray

1.1.4 Marking

1.1.4.1 Marker

Item No.: 2009-145/000-006

Mini-WSB Inline; for Smart Printer; 1700 pieces on roll; stretchable 5 - 5.2 mm; plain; snap-on type; blue

Item No.: 2009-145/000-007

Mini-WSB Inline; for Smart Printer; 1700 pieces on roll; stretchable 5 - 5.2 mm; plain; snap-on type; gray

Item No.: 2009-145/000-023

Mini-WSB Inline; for Smart Printer; 1700 pieces on roll; stretchable 5 - 5.2 mm; plain; snap-on type; green

Item No.: 2009-145/000-012

Mini-WSB Inline; for Smart Printer; 1700 pieces on roll; stretchable 5 - 5.2 mm; plain; snap-on type; orange

Item No.: 2009-145/000-005

Mini-WSB Inline; for Smart Printer; 1700 pieces on roll; stretchable 5 - 5.2 mm; plain; snap-on type; red

Item No.: 2009-145/000-024

Mini-WSB Inline; for Smart Printer; 1700 pieces on roll; stretchable 5 - 5.2 mm; plain; snap-on type; violet

Item No.: 2009-145

Mini-WSB Inline; for Smart Printer; 1700 pieces on roll; stretchable 5 - 5.2 mm; plain; snap-on type; white

Item No.: 2009-145/000-002

Mini-WSB Inline; for Smart Printer; 1700 pieces on roll; stretchable 5 - 5.2 mm; plain; snap-on type; yellow



Item No.: 248-501/000-006

Mini-WSB marking card; as card; not stretchable; plain; snap-on type; blue

Item No.: 248-501/000-007

Mini-WSB marking card; as card; not stretchable; plain; snap-on type; gray

Item No.: 248-501/000-023

Mini-WSB marking card; as card; not stretchable; plain; snap-on type; green

Item No.: 248-501/000-017

Mini-WSB marking card; as card; not stretchable; plain; snap-on type; light green



Item No.: 248-501/000-012

Mini-WSB marking card; as card; not stretchable; plain; snap-on type; orange

Item No.: 248-501/000-005

Mini-WSB marking card; as card; not stretchable; plain; snap-on type; red

Item No.: 248-501/000-024

Mini-WSB marking card; as card; not stretchable; plain; snap-on type; violet

Item No.: 248-501

Mini-WSB marking card; as card; not stretchable; plain; snap-on type; white



Item No.: 248-501/000-002

Mini-WSB marking card; as card; not stretchable; plain; snap-on type; yellow

1.1.5 Test and measurement

1.1.5.1 Testing accessories



Item No.: 210-136

Test plug; 2 mm Ø; with 500 mm cable; red

1.1.6 Tool

1.1.6.1 Operating tool



Item No.: 210-658

Operating tool; Blade: 3.5 x 0.5 mm; with a partially insulated shaft; angled; short; multicoloured



Item No.: 210-720

Operating tool; Blade: 3.5 x 0.5 mm; with a partially insulated shaft; multicoloured



Item No.: 210-657

Operating tool; Blade: 3.5 x 0.5 mm; with a partially insulated shaft; short; multicoloured

Installation Notes

Conductor termination

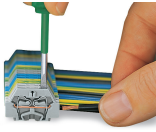

CAGE CLAMP® connection

Inserting a conductor.

With ferruled conductors, it is necessary to use a terminal block one size larger than the conductor's nominal cross-section.

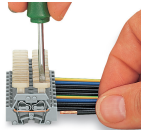

CAGE CLAMP® connection

Inserting a conductor via push-button.

Commoning

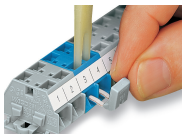

Commoning with comb-style jumper bar.

Testing



Testing with voltage tester.

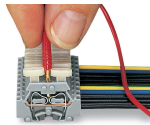

Testing with a 2 mm Ø test plug – touch contact.

Installation

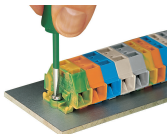

Mounting and securing a terminal strip directly to the plate via screw-type flanges.

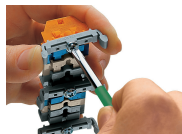

Terminal strip with mounting flanges
Screwing a mounting foot (209-123).
(Distance between mounting feet: approx. 25 ... 30 mm)

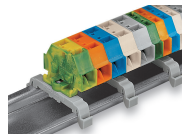

Terminal strip; with mounting flanges; for DIN-35 rail

Marking

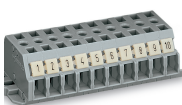

Terminal strip with marker slot for Mini-WSB Quick Marking System

Subject to changes. Please also observe the further product documentation!

Current addresses can be found at: www.wago.com