

## Data Sheet | Item Number: 264-192

2-conductor terminal strip; without push-buttons; suitable for Ex e II applications; with snap-in mounting feet; 12-pole; for plate thickness 0.6 - 1.2 mm; Fixing hole 3.5 mm Ø; 2.5 mm<sup>2</sup>; CAGE CLAMP®; 2,50 mm<sup>2</sup>; light gray



<https://www.wago.com/264-192>



Color: ■ light gray

Similar to illustration

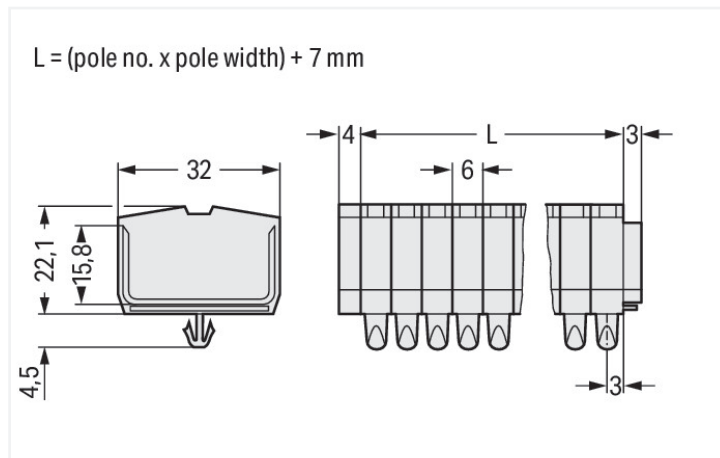

Dimensions in mm

### Through terminal block, 264 Series, operating tool

Our through terminal block (item number 264-192) simplifies electrical installations. Conductors should only be connected to this through terminal block if their strip length is between 8 and 9 mm. Our mini rail-mount terminal blocks are the perfect choice for working in confined spaces. A large selection of mounting and actuation variants means you can find a suitable mini terminal block for every purpose. This also means you can adapt the terminal blocks to your unique requirements. Featuring conductor terminals along with CAGE CLAMP®, this connector outperforms the competition. Our renowned universal connection known as CAGE CLAMP® is industry-leading when it comes to connection technology and electrical interconnections. Dimensions: (79 x 32 x 22.1) mm (width x height x depth). This through terminal block is suitable for conductor cross sections ranging from 0.08 mm<sup>2</sup> to 2.5 mm<sup>2</sup>.

An operating tool is used to operate this mini rail-mount terminal block.

### Electrical data

#### Ex information

Reference to hazardous areas	See "Downloads – Documentation – Additional Information: Technical Section; Technical Explications"
Rated voltage EN (Ex e II)	690 V
Rated current (Ex e II)	23 A

#### General information

Wiring direction	Front-entry wiring
------------------	--------------------

### Connection Data

Clamping units	24
Total number of potentials	12
Number of levels	1

#### Connection 1

Connection technology	CAGE CLAMP®
Actuation type	Operating tool
Connectable conductor materials	Copper
Solid conductor	0.08 ... 2.5 mm <sup>2</sup> / 28 ... 12 AWG
Fine-stranded conductor	0.08 ... 2.5 mm <sup>2</sup> / 28 ... 12 AWG
Note (conductor cross-section)	12 AWG: THHN, THWN
Strip length	8 ... 9 mm / 0.31 ... 0.35 inches

### Connection 1

Pole number	12
Wiring direction	Front-entry wiring

### Physical data

Width	79 mm / 3.11 inches
Height	32 mm / 1.26 inches
Height from the surface	22.1 mm / 0.87 inches
Depth	22.1 mm / 0.87 inches
Module width	6 mm / 0.236 inches

### Mechanical data

Design	horizontal type
Mounting type	Snap-in foot
Marking level	Center marking

### Material data

Note (material data)	<a href="#">Information on material specifications can be found here</a>
Color	light gray
Material group	I
Insulation material (main housing)	Polyamide (PA66)
Flammability class per UL94	V0
Fire load	0.956 MJ
Halogen-free	Yes
Weight	48 g

### Commercial data

Product Group	9 (Std Chassis Mt Blocks)
PU (SPU)	25 pcs
Packaging type	Box
Country of origin	DE
GTIN	4044918423359
Customs tariff number	85369010000

### Product Classification

UNSPSC	39121410
eCl@ss 10.0	27-14-11-06
eCl@ss 9.0	27-14-11-06
ETIM 9.0	EC001284
ETIM 10.0	EC001284
ECCN	NO US CLASSIFICATION

Environmental Product Compliance	
RoHS Compliance Status	Compliant, No Exemption

### Approvals / Certificates

#### General approvals



Approval	Standard	Certificate Name
CSA DEKRA Certification B.V.	C22.2	70010891
UR Underwriters Laboratories Inc.	UL 1059	E45172

#### Declarations of conformity and manufacturer's declarations

Approval	Standard	Certificate Name
ATEX-Attestation of Conformity WAGO GmbH & Co. KG	-	-

#### Approvals for marine applications



Approval	Standard	Certificate Name
LR Lloyds Register	IEC 60998	LR22173030TA

#### Approvals for hazardous areas



Approval	Standard	Certificate Name
AEx UL International Germany GmbH c/o Physikalisch Technische Bundesanstalt	UL 60079	E185892 (AEx eb IIC resp. Ex eb IIC)
ATEX Physikalisch Technische Bundesanstalt (PTB)	EN 60079	PTB 98 ATEX 3129 U (II 2 G Ex eb IIC Gb bzw. I M 2 Ex eb I Mb)
CCC CQST/CNEx	GB/T 3836.3	2020312313000187 (Ex eb IIC Gb, Ex eb I Mb)
IECEx Physikalisch Technische Bundesanstalt (PTB)	IEC 60079	IECEx PTB 04.0003U (Ex e IIC Gb and Ex eb I Mb)
INMETRO TÜV Rheinland do Brasil Ltda.	IEC 60079	TÜV 12.1299 U

### Downloads

#### Environmental Product Compliance

Compliance Search
Environmental Product Compliance 264-192

## Documentation

Bid Text			
264-192	19.02.2019	xml 3.28 KB	
264-192	14.06.2017	doc 25.00 KB	

## CAD/CAE-Data

CAD data	
2D/3D Models 264-192	

CAE data	
EPLAN Data Portal 264-192	
WSCAD Universe 264-192	
ZUKEN Portal 264-192	

## 1 Compatible Products

### 1.1 Optional Accessories

#### 1.1.1 DIN-rail

##### 1.1.1.1 Mounting accessories



**Item No.: 210-154**  
Aluminum carrier rail; 1000 mm long; 18 mm wide; 7 mm high; silver-colored

### 1.1.2 Ferrule

#### 1.1.2.1 Ferrule

 <b>Item No.: 216-131</b> Ferrule; Sleeve for 0.25 mm <sup>2</sup> / AWG 24; uninsulated; electro-tin plated; silver-colored	 <b>Item No.: 216-201</b> Ferrule; Sleeve for 0.5 mm <sup>2</sup> / 20 AWG; insulated; electro-tin plated; electrolytic copper; acc. to DIN 46228, Part 4/09.90; white	 <b>Item No.: 216-101</b> Ferrule; Sleeve for 0.5 mm <sup>2</sup> / AWG 22; uninsulated; electro-tin plated; silver-colored	 <b>Item No.: 216-202</b> Ferrule; Sleeve for 0.75 mm <sup>2</sup> / 18 AWG; insulated; electro-tin plated; gray
 <b>Item No.: 216-102</b> Ferrule; Sleeve for 0.75 mm <sup>2</sup> / AWG 20; uninsulated; electro-tin plated; silver-colored	 <b>Item No.: 216-203</b> Ferrule; Sleeve for 1 mm <sup>2</sup> / AWG 18; insulated; electro-tin plated; red	 <b>Item No.: 216-103</b> Ferrule; Sleeve for 1 mm <sup>2</sup> / AWG 18; uninsulated; electro-tin plated	 <b>Item No.: 216-204</b> Ferrule; Sleeve for 1.5 mm <sup>2</sup> / AWG 16; insulated; electro-tin plated; black
 <b>Item No.: 216-104</b> Ferrule; Sleeve for 1.5 mm <sup>2</sup> / AWG 16; uninsulated; electro-tin plated; silver-colored	 <b>Item No.: 216-205</b> Ferrule; Sleeve for 2.08 mm <sup>2</sup> / AWG 14; insulated; electro-tin plated; yellow	 <b>Item No.: 216-206</b> Ferrule; Sleeve for 2.5 mm <sup>2</sup> / AWG 14; insulated; electro-tin plated; blue	 <b>Item No.: 216-106</b> Ferrule; Sleeve for 2.5 mm <sup>2</sup> / AWG 14; uninsulated; electro-tin plated; silver-colored

### 1.1.3 Installation

#### 1.1.3.1 Cover



**Item No.: 709-153**

Cover; Type 1; suitable for cover carrier, type 1; 1 m long; transparent

#### 1.1.3.2 Cover carrier



**Item No.: 709-167**

Cover carrier; Type 1; incl. fixing/retaining screws and knurled nut; suitable for 279 to 282 and 880 Series rail-mounted terminal blocks; suitable for 264 Series miniature rail-mounted terminal blocks; suitable for 270 Series sensor and actuator terminal blocks; gray

### 1.1.4 Jumper

#### 1.1.4.1 Jumper



**Item No.: 281-492**

Jumper; 2-way; insulated; gray



**Item No.: 264-402**

Jumper; for conductor entry; 2-way; insulated; gray

### 1.1.5 Marking

#### 1.1.5.1 Marker

**Item No.: 2009-145/000-006**

Mini-WSB Inline; for Smart Printer; 1700 pieces on roll; stretchable 5 - 5.2 mm; plain; snap-on type; blue

**Item No.: 2009-145/000-007**

Mini-WSB Inline; for Smart Printer; 1700 pieces on roll; stretchable 5 - 5.2 mm; plain; snap-on type; gray

**Item No.: 2009-145/000-023**

Mini-WSB Inline; for Smart Printer; 1700 pieces on roll; stretchable 5 - 5.2 mm; plain; snap-on type; green

**Item No.: 2009-145/000-012**

Mini-WSB Inline; for Smart Printer; 1700 pieces on roll; stretchable 5 - 5.2 mm; plain; snap-on type; orange

**Item No.: 2009-145/000-005**

Mini-WSB Inline; for Smart Printer; 1700 pieces on roll; stretchable 5 - 5.2 mm; plain; snap-on type; red

**Item No.: 2009-145/000-024**

Mini-WSB Inline; for Smart Printer; 1700 pieces on roll; stretchable 5 - 5.2 mm; plain; snap-on type; violet

**Item No.: 2009-145**

Mini-WSB Inline; for Smart Printer; 1700 pieces on roll; stretchable 5 - 5.2 mm; plain; snap-on type; white

**Item No.: 2009-145/000-002**

Mini-WSB Inline; for Smart Printer; 1700 pieces on roll; stretchable 5 - 5.2 mm; plain; snap-on type; yellow



**Item No.: 248-501/000-006**

Mini-WSB marking card; as card; not stretchable; plain; snap-on type; blue

**Item No.: 248-501/000-007**

Mini-WSB marking card; as card; not stretchable; plain; snap-on type; gray

**Item No.: 248-501/000-023**

Mini-WSB marking card; as card; not stretchable; plain; snap-on type; green

**Item No.: 248-501/000-017**

Mini-WSB marking card; as card; not stretchable; plain; snap-on type; light green



**Item No.: 248-501/000-012**

Mini-WSB marking card; as card; not stretchable; plain; snap-on type; orange

**Item No.: 248-501/000-005**

Mini-WSB marking card; as card; not stretchable; plain; snap-on type; red

**Item No.: 248-501/000-024**

Mini-WSB marking card; as card; not stretchable; plain; snap-on type; violet

**Item No.: 248-501**

Mini-WSB marking card; as card; not stretchable; plain; snap-on type; white



**Item No.: 248-501/000-002**

Mini-WSB marking card; as card; not stretchable; plain; snap-on type; yellow

### 1.1.6 Tool

#### 1.1.6.1 Operating tool



**Item No.: 210-658**

Operating tool; Blade: 3.5 x 0.5 mm; with a partially insulated shaft; angled; short; multicoloured



**Item No.: 210-720**

Operating tool; Blade: 3.5 x 0.5 mm; with a partially insulated shaft; multicoloured



**Item No.: 210-657**

Operating tool; Blade: 3.5 x 0.5 mm; with a partially insulated shaft; short; multicoloured



**Item No.: 209-130**

Operating tool; made of insulating material; 1-way; for 264 Series (1-/2-way), 280, 281 Series (up to 3-way); natural

### Installation Notes

#### Installation

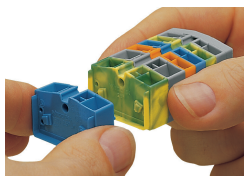

Assembling modular terminal blocks into terminal strips.

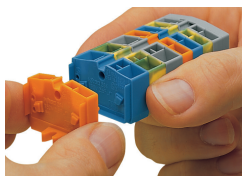

Mounting an "end terminal block" with mounting flange.

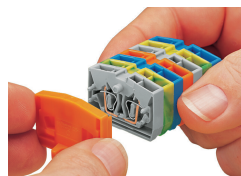

Mounting an end plate.

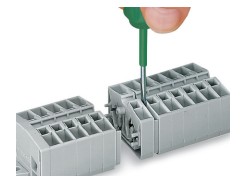

Removing a terminal block.

### Conductor termination

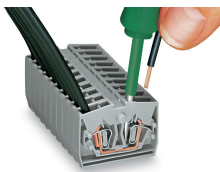

**CAGE CLAMP® connection**

Inserting a conductor.  
With ferruled conductors, it is necessary to use a terminal block one size smaller than the conductor's nominal cross-section.

### Commoning

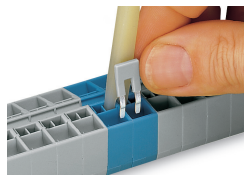

Commoning with comb-style jumper bar.

### Testing

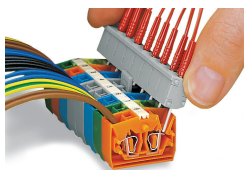

Testing by touch contact to the CAGE CLAMP® spring (limited to 0.5 A and 48 V test voltage) – test pins are not protected against accidental contact.

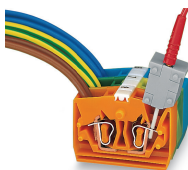

Testing via CAGE CLAMP® on the current bar (max. nominal current: 6 A). CAGE CLAMP® clamps individual test contacts. The maximum test voltage is 400 V.

Marking



Marking via Mini-WSB Quick Marking System.