

Data Sheet | Item Number: 831-505

Strain relief plate; for female and male connectors; 30 mm wide; 1 part; Pin spacing 7.62 mm; light gray

<https://www.wago.com/831-505>



Color: ■ light gray

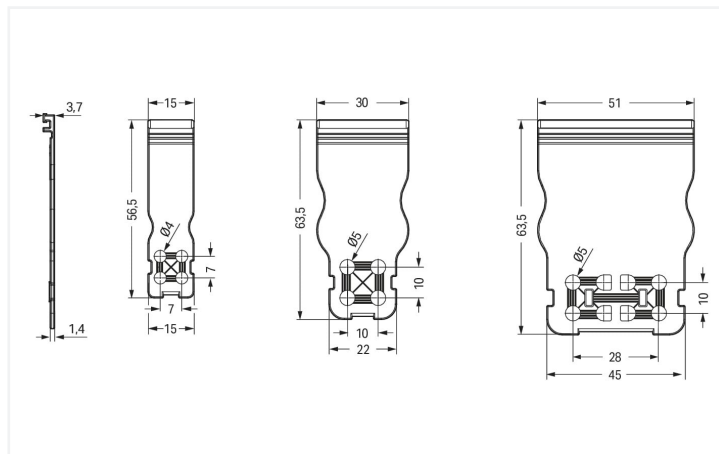

Dimensions in mm

The arrangement of the attachments for cable ties allows single conductors or multi-core cables to be secured in different ways. The width of the cable ties must correspond to the hole dimensions of the strain relief plates shown above.

Physical data

Width	30 mm / 1.181 inches
Height	3.7 mm / 0.146 inches
Depth	63.5 mm / 2.5 inches

Mechanical data

Suitable	for standard male and female connectors
----------	---

Material data

Note (material data)	Information on material specifications can be found here
Color	light gray
Material group	I
Insulation material	Polyamide (PA66)
Flammability class per UL94	V0
Fire load	0 MJ
Weight	2.6 g

Commercial data

eCl@ss 10.0	27-14-11-92
eCl@ss 9.0	27-14-11-92
ETIM 8.0	EC002848
ETIM 7.0	EC002848
PU (SPU)	48 (24) pcs
Packaging type	Box
Country of origin	DE
GTIN	4055143371605
Customs tariff number	85389099990

Environmental Product Compliance

RoHS Compliance Status

Compliant, No Exemption

Downloads

Environmental Product Compliance

Compliance Search

Environmental Product
Compliance 831-505



Documentation

Additional Information

Technical Section

03.04.2019

pdf

2010.85 KB



CAD/CAE-Data

CAD data

2D/3D Models 831-505



CAE data

ZUKEN Portal 831-505



Installation Notes

Installation

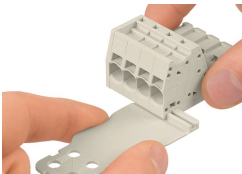

Strain relief plate, for field assembly

Application

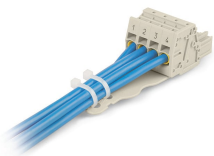

Strain relief plate, for factory assembly
1-conductor female conductor, 4-pole,
7.62 mm pin spacing, light gray
(831-3104/135-000)

Subject to changes. Please also observe the further product documentation!

Current addresses can be found at: www.wago.com