

Data Sheet | Item Number: 264-103

2-conductor terminal strip; without push-buttons; with fixing flanges; 3-pole; for screw or similar mounting types; Fixing hole 3.2 mm Ø; 2.5 mm²; CAGE CLAMP®; gray

<https://www.wago.com/264-103>

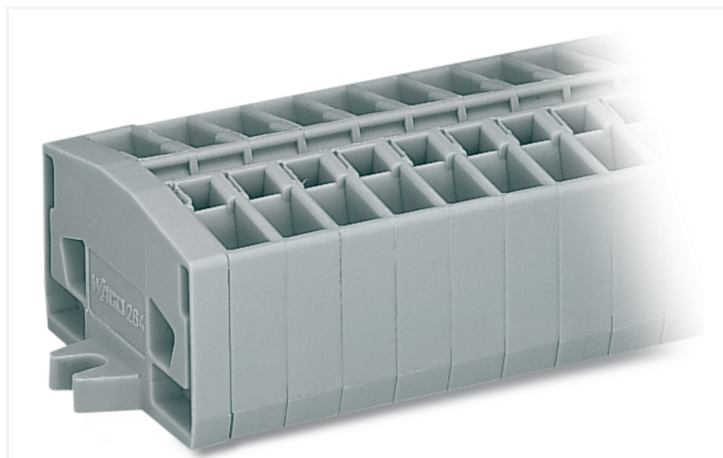

Color: ■ gray

Similar to illustration

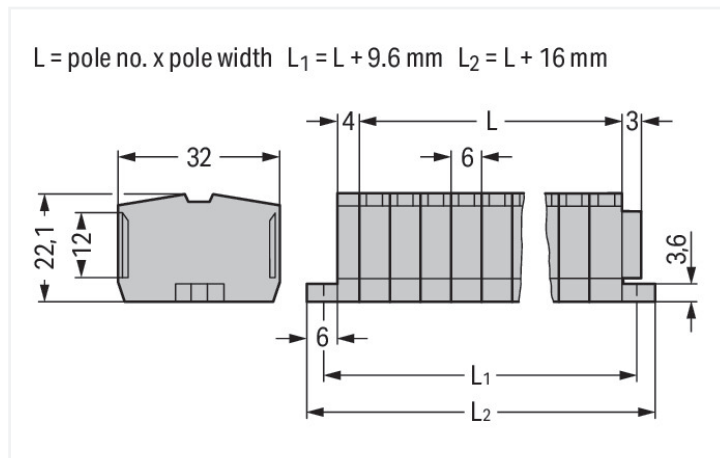

Dimensions in mm

Through terminal block, 264 Series, CAGE CLAMP®

This through terminal block (item number 264-103) is designed to connect conductors quickly and easily. Ensure that the strip lengths are between 8 and 9 mm when connecting conductors to this through terminal block. Our mini rail-mount terminal blocks are perfect for working in confined spaces thanks to their compact design. With various mounting and actuation options, they offer maximum flexibility. Featuring conductor terminals along with CAGE CLAMP®, this product delivers reliable performance. Our CAGE CLAMP® connection offers a reliable and maintenance-free way to connect all types of conductors. You do not need to prepare the conductor in any way, such as crimping ferrules. The item's dimensions are (34 x 32 x 22.1) mm (width x height x depth). Depending on the conductor type, this through terminal block is ideal for conductor cross sections ranging from 0.08 mm² to 2.5 mm².

An operating tool is used to operate this mini rail-mount terminal block.

Electrical data

Ratings per IEC/EN

| | |
|-------------------------------------------|-----------------------------------------------------------|
| Nominal voltage (III/3) | 800 V |
| Rated impulse withstand voltage (III / 3) | 8 kV |
| Rated current | 24 A |
| Legend (ratings) | (III / 3) ≙ Overvoltage category III / Pollution degree 3 |

Approvals per

UL 1059

| Use group | B | C | D |
|---------------|-------|-------|---|
| Rated voltage | 600 V | 600 V | - |
| Rated current | 20 A | 20 A | - |

Approvals per

CSA 22.2 No 158

| Use group | B | C | D |
|---------------|---|-------|---|
| Rated voltage | - | 600 V | - |
| Rated current | - | 20 A | - |

General information

| | |
|------------------|--------------------|
| Wiring direction | Front-entry wiring |
|------------------|--------------------|

Connection Data

| | |
|----------------------------|---|
| Clamping units | 6 |
| Total number of potentials | 3 |
| Number of levels | 1 |

Connection 1

| | |
|---------------------------------|----------------------------------------------|
| Connection technology | CAGE CLAMP® |
| Actuation type | Operating tool |
| Connectable conductor materials | Copper |
| Solid conductor | 0.08 ... 2.5 mm ² / 28 ... 12 AWG |
| Fine-stranded conductor | 0.08 ... 2.5 mm ² / 28 ... 12 AWG |
| Note (conductor cross-section) | 12 AWG: THHN, THWN |
| Strip length | 8 ... 9 mm / 0.31 ... 0.35 inches |
| Pole number | 3 |

Physical data

| | |
|--------------|-----------------------|
| Width | 34 mm / 1.339 inches |
| Height | 32 mm / 1.26 inches |
| Depth | 22.1 mm / 0.87 inches |
| Module width | 6 mm / 0.236 inches |

Mechanical data

| | |
|---------------|-----------------|
| Design | horizontal type |
| Mounting type | Mounting flange |
| Marking level | Center marking |

Material data

| | |
|------------------------------------|--------------------------------------------------------------------------|
| Note (material data) | Information on material specifications can be found here |
| Color | gray |
| Material group | I |
| Insulation material (main housing) | Polyamide (PA66) |
| Flammability class per UL94 | V0 |
| Fire load | 0.283 MJ |
| Halogen-free | Yes |
| Weight | 13.6 g |

Commercial data

| | |
|-----------------------|---------------|
| PU (SPU) | 100 pcs |
| Packaging type | Box |
| Country of origin | DE |
| GTIN | 4044918425827 |
| Customs tariff number | 85369010000 |

Product Classification

| | |
|-------------|----------------------|
| UNSPSC | 39121410 |
| eCl@ss 10.0 | 27-14-11-06 |
| eCl@ss 9.0 | 27-14-11-06 |
| ETIM 9.0 | EC001284 |
| ETIM 10.0 | EC001284 |
| ECCN | NO US CLASSIFICATION |

Environmental Product Compliance

| | |
|------------------------|-------------------------|
| RoHS Compliance Status | Compliant, No Exemption |
|------------------------|-------------------------|

Approvals / Certificates

General approvals



| Approval | Standard | Certificate Name |
|--------------------------------------|----------|------------------|
| CB DEKRA Certification B.V. | EN 60998 | NL-49768 |
| CCA DEKRA Certification B.V. | EN 60998 | NTR NL-7342 |
| CCA DEKRA Certification B.V. | EN 60998 | 2175624.01 |
| CSA DEKRA Certification B.V. | C22.2 | 70010891 |
| UR Underwriters Laboratories Inc. | UL 1059 | E45172 |

Declarations of conformity and manufacturer's declarations

| Approval | Standard | Certificate Name |
|----------------------------------------------------|----------|------------------|
| EU-Declaration of Conformity WAGO GmbH & Co. KG | - | - |
| UK-Declaration of Conformity WAGO GmbH & Co. KG | - | - |

Approvals for marine applications



| Approval | Standard | Certificate Name |
|--------------------------------------------------|-----------|-------------------|
| ABS American Bureau of Shipping | - | 24-0095979-PDA |
| DNV GL Det Norske Veritas, Germanischer Lloyd | - | TAE00001V2 |
| LR Lloyds Register | IEC 60998 | LR22173030TA |
| PRS Polski Rejestr Statków | - | TE/1094/880590/23 |

Downloads

Environmental Product Compliance

| |
|------------------------------------------|
| Compliance Search |
| Environmental Product Compliance 264-103 |

Documentation

| Bid Text | | | |
|----------|------------|-----------------|--|
| 264-103 | 19.02.2019 | xml 3.22 KB | |
| 264-103 | 14.06.2017 | doc 24.00 KB | |

CAD/CAE-Data

| CAD data | CAE data |
|----------------------|---------------------------|
| 2D/3D Models 264-103 | EPLAN Data Portal 264-103 |
| | WSCAD Universe 264-103 |
| | ZUKEN Portal 264-103 |

1 Compatible Products

1.1 Optional Accessories

1.1.1 Ferrule

1.1.1.1 Ferrule

| | | | |
|------------------------------------------------------------------------------------------------------------------------------------|------------------------------------------------------------------------------------------------------------------------------------------------------------------------------|-----------------------------------------------------------------------------------------------------------------------------------|-----------------------------------------------------------------------------------------------------------------------------------|
| Item No.: 216-131 Ferrule; Sleeve for 0.25 mm ² / AWG 24; uninsulated; electro-tin plated; silver-colored | Item No.: 216-201 Ferrule; Sleeve for 0.5 mm ² / 20 AWG; insulated; electro-tin plated; electrolytic copper; acc. to DIN 46228, Part 4/09.90; white | Item No.: 216-101 Ferrule; Sleeve for 0.5 mm ² / AWG 22; uninsulated; electro-tin plated; silver-colored | Item No.: 216-202 Ferrule; Sleeve for 0.75 mm ² / 18 AWG; insulated; electro-tin plated; gray |
| Item No.: 216-102 Ferrule; Sleeve for 0.75 mm ² / AWG 20; uninsulated; electro-tin plated; silver-colored | Item No.: 216-203 Ferrule; Sleeve for 1 mm ² / AWG 18; insulated; electro-tin plated; red | Item No.: 216-103 Ferrule; Sleeve for 1 mm ² / AWG 18; uninsulated; electro-tin plated | Item No.: 216-204 Ferrule; Sleeve for 1.5 mm ² / AWG 16; insulated; electro-tin plated; black |
| Item No.: 216-104 Ferrule; Sleeve for 1.5 mm ² / AWG 16; uninsulated; electro-tin plated; silver-colored | Item No.: 216-205 Ferrule; Sleeve for 2.08 mm ² / AWG 14; insulated; electro-tin plated; yellow | Item No.: 216-206 Ferrule; Sleeve for 2.5 mm ² / AWG 14; insulated; electro-tin plated; blue | Item No.: 216-106 Ferrule; Sleeve for 2.5 mm ² / AWG 14; uninsulated; electro-tin plated; silver-colored |

1.1.2 Installation

1.1.2.1 Cover



Item No.: 709-153
Cover; Type 1; suitable for cover carrier, type 1; 1 m long; transparent

1.1.2.2 Cover carrier



Item No.: 709-167

Cover carrier; Type 1; incl. fixing/retaining screws and knurled nut; suitable for 279 to 282 and 880 Series rail-mounted terminal blocks; suitable for 264 Series miniature rail-mounted terminal blocks; suitable for 270 Series sensor and actuator terminal blocks; gray

1.1.3 Jumper

1.1.3.1 Jumper



Item No.: 281-492

Jumper; 2-way; insulated; gray



Item No.: 264-402

Jumper; for conductor entry; 2-way; insulated; gray

1.1.4 Marking

1.1.4.1 Marker

Item No.: 2009-145/000-006

Mini-WSB Inline; for Smart Printer; 1700 pieces on roll; stretchable 5 - 5.2 mm; plain; snap-on type; blue

Item No.: 2009-145/000-007

Mini-WSB Inline; for Smart Printer; 1700 pieces on roll; stretchable 5 - 5.2 mm; plain; snap-on type; gray

Item No.: 2009-145/000-023

Mini-WSB Inline; for Smart Printer; 1700 pieces on roll; stretchable 5 - 5.2 mm; plain; snap-on type; green

Item No.: 2009-145/000-012

Mini-WSB Inline; for Smart Printer; 1700 pieces on roll; stretchable 5 - 5.2 mm; plain; snap-on type; orange

Item No.: 2009-145/000-005

Mini-WSB Inline; for Smart Printer; 1700 pieces on roll; stretchable 5 - 5.2 mm; plain; snap-on type; red

Item No.: 2009-145/000-024

Mini-WSB Inline; for Smart Printer; 1700 pieces on roll; stretchable 5 - 5.2 mm; plain; snap-on type; violet

Item No.: 2009-145

Mini-WSB Inline; for Smart Printer; 1700 pieces on roll; stretchable 5 - 5.2 mm; plain; snap-on type; white

Item No.: 2009-145/000-002

Mini-WSB Inline; for Smart Printer; 1700 pieces on roll; stretchable 5 - 5.2 mm; plain; snap-on type; yellow



Item No.: 248-501/000-006

Mini-WSB marking card; as card; not stretchable; plain; snap-on type; blue



Item No.: 248-501/000-007

Mini-WSB marking card; as card; not stretchable; plain; snap-on type; gray

Item No.: 248-501/000-023

Mini-WSB marking card; as card; not stretchable; plain; snap-on type; green



Item No.: 248-501/000-017

Mini-WSB marking card; as card; not stretchable; plain; snap-on type; light green



Item No.: 248-501/000-012

Mini-WSB marking card; as card; not stretchable; plain; snap-on type; orange



Item No.: 248-501/000-005

Mini-WSB marking card; as card; not stretchable; plain; snap-on type; red

Item No.: 248-501/000-024

Mini-WSB marking card; as card; not stretchable; plain; snap-on type; violet



Item No.: 248-501

Mini-WSB marking card; as card; not stretchable; plain; snap-on type; white



Item No.: 248-501/000-002

Mini-WSB marking card; as card; not stretchable; plain; snap-on type; yellow

1.1.5 Test and measurement

1.1.5.1 Testing accessories



Item No.: 249-136

Test plug module; without locking device; modular; for 2-conductor terminal blocks; gray



Item No.: 210-136

Test plug; 2 mm Ø; with 500 mm cable; red

1.1.6 Tool

1.1.6.1 Operating tool



Item No.: 210-658

Operating tool; Blade: 3.5 x 0.5 mm; with a partially insulated shaft; angled; short; multicoloured



Item No.: 210-720

Operating tool; Blade: 3.5 x 0.5 mm; with a partially insulated shaft; multicoloured



Item No.: 210-657

Operating tool; Blade: 3.5 x 0.5 mm; with a partially insulated shaft; short; multicoloured



Item No.: 209-130

Operating tool; made of insulating material; 1-way; for 264 Series (1-/2-way), 280, 281 Series (up to 3-way); natural

Installation Notes

Installation

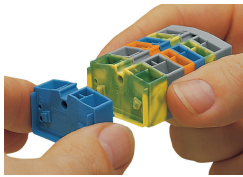

Assembling modular terminal blocks into terminal strips.

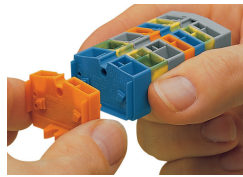

Mounting an "end terminal block" with mounting flange.

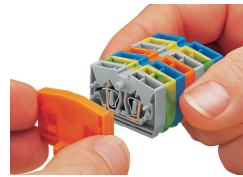

Mounting an end plate.

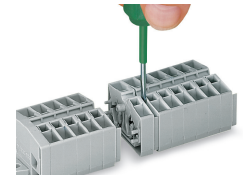

Removing a terminal block.

Conductor termination



CAGE CLAMP® connection

Inserting a conductor. With ferruled conductors, it is necessary to use a terminal block one size smaller than the conductor's nominal cross-section.

Commoning

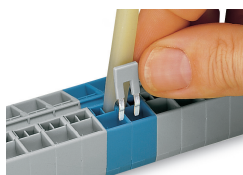

Commoning with comb-style jumper bar.

Testing

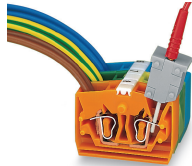
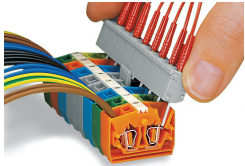

Testing by touch contact to the CAGE CLAMP® spring (limited to 0.5 A and 48 V test voltage) – test pins are not protected against accidental contact.

Testing via CAGE CLAMP® on the current bar (max. nominal current: 6 A). CAGE CLAMP® clamps individual test contacts. The maximum test voltage is 400 V.



Terminal strip with mounting flanges:

- End plate with mounting flange
- Center terminal blocks
- End terminal block with mounting flange

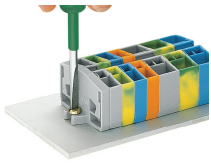

Mounting and securing a terminal strip directly to the plate via screw-type flanges.

Marking

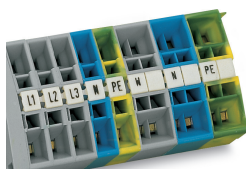

Marking via Mini-WSB Quick Marking System.