

**IT**MANUALE  
TECNICO**EN**TECHNICAL  
MANUAL**FR**MANUEL  
TECHNIQUE**NL**TECHNISCHE  
HANDLEIDING**ES**MANUAL  
TÉCNICO

Art. 48SAE000 Sirena elettronica IP66

Art. 48SAE000 Electronic siren, IP66

Art. 48SAE000 Sirène électronique IP66

Art. 48SAE000 Elektronische sirene IP66

Art. 48SAE000 Sirena electrónica IP66

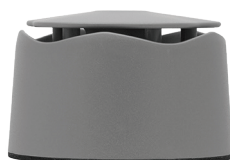
**Comelit**<sup>®</sup>  
 Passion. Technology. Design.

**IT** Sirena da esterno con elevata resa acustica e basso assorbimento con 32 toni selezionabili.

**CARATTERISTICHE TECNICHE**

Potenza sonora max.	110dB a 1m
Consumo max.	39mA
Grado di protezione	IP66 (staffa di fissaggio art.48SAE001 per grado IP66 non inclusa)
Tensione di alimentazione	9-30 Vdc
Dimensioni	92mm (diametro)x 95mm

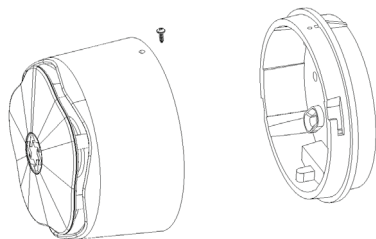
**BASE BASSA IP45**

Forare il fondo della base per le viti di fissaggio, far passare il cavo o dal fondo, o dalle preforature laterali.

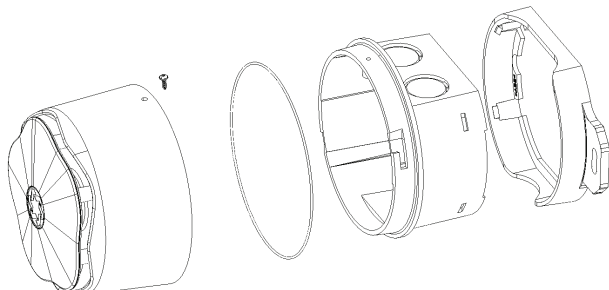
**BASE ALTA IP66**

Per garantire il grado IP66 del dispositivo non forare la base e usare la staffa 48SAE001.

Usare pressacavi da 20mm da montare sulle apposite preformature, inserire la guarnizione tra base e corpo sirena.

**SPECIFICHE ELETTRICHE**

Tensione operativa	9 – 30 VDC
Non usato	Switch 6
Corrente	Vedi tabella toni
Temperatura di funzionamento	da - 40° C a + 70°C
Sincronizzazione	Accensione

N°	Frequenza	2° Tono	Codice 12345	Descrizione	EN54-3 28Vdc vedi note	Tipo SPL@1m sull'asse		Corrente mA	
						12V	24V	12V	24V
1	800Hz to 950Hz swept at 120Hz	4	0000	Banshee Buzz LF		94	101	6	12
2	800Hz to 950Hz swept at 9Hz	4	1000	Banshee Fast Sweep LF	98	94	101	6	12
3	800Hz to 950Hz swept at 3Hz	4	01000	Banshee Slow Sweep LF		94	101	6	12
4	Continuous at 900Hz	4	11000	Banshee Continuous LF		94	101	6	12
5	830Hz to 970Hz swept at 9Hz	4	00100	Banshee Fast Sweep LF (New)		95	101	6	12
6	800Hz to 970Hz swept at 1Hz	7	10100	Medium Sweep LF	98	96	101	6	12
7	Continuous at 950Hz	7	01100	Continuous LF		96	102	6	13
8	Intermittent at 950Hz 1 sec on, 1 sec off	4	11100	Back Up Alarm LF		96	102	8	14
9	Alternating 800Hz/1000Hz at 1Hz	4	00010	Alternate LF		94	100	6	13
10	800Hz to 1000Hz swept at 0.5 secs	4	10010	Medium Sweep LF		95	101	6	12
11	Alternating Tones 800/950Hz at 3Hz	4	01010	Alternate LF		96	101	6	12
12	2400Hz to 2900Hz at 120Hz	15	11010	Banshee Buzz HF		102	110	16	35
13	2400Hz to 2900Hz at 9Hz	15	00110	Banshee Fast Sweep HF		103	110	17	35
14	2400Hz to 2900Hz at 3Hz	15	10110	Banshee Slow Sweep HF		103	110	17	35
15	Continuous 2900Hz	15	01110	Banshee Continuous HF		103	110	19	39
16	2450Hz to 3100Hz swept at 9Hz	15	11110	Banshee Fast Sweep HF (New)		103	110	18	36
17	Intermittent at 2900Hz 1 sec on, 1 sec off	15	00001	Back Up Alarm HF		104	110	18	36
18	Alternating Tones 2400/2900 at 3Hz	15	10001	Alternate HF		104	110	16	36
19	500Hz rising to 1200Hz over 3.5 sec, silence 0.5 sec	4	01001	Slow Whoop	98	95	101	6	12
20	1200Hz falling to 500Hz over 1 sec, silence 10mS	4	11001	Din Tone (DK)	97	93	100	5	10
21	554Hz for 100mS and 440Hz for 400mS	4	00101	French Fire Sounder	93	90	96	4	7
22	420Hz repeating 0.625 sec on, 0.625 sec off	4	10101	Australian Alert Signal		89	95	3	6
23	500Hz to 1200Hz sweeping, 3.75 secs on, 0.25 secs off	4	01101	Australian Evacuation Signal		95	103	6	12
24	950Hz for 0.5 sec on, 0.5 sec off for 3 phases, silence for 1.5 secs	4	11101	US Temporal Tone LF		95	101	5	10
25	2900Hz for 0.5sec on, 0.5sec off for 3 phases, silence for 1.5 sec	15	00011	US Temporal Tone HF		104	110	13	26
26	Intermittent 660Hz 150mS on, 150mS off	26	10011	Swedish Tone (Fire)		90	96	3	6
27	Continuous 660Hz	27	01011	Swedish Tone (All Clear)		91	97	5	9
28	Intermittent 970Hz 500mS on, 500mS off	28	11011	ISO8201 LF		93	99	5	10
29	Intermittent 2900Hz 500mS on, 500mS off	29	00111	ISO8201 HF		103	110	13	27
30	Yodel 800Hz/1000Hz, 0.25sec	31	10111	BT Banshee (FP1063,1)		93	100	6	12
31	Continuous 1000Hz	31	01111	BT Banshee (FP1063,1)		90	96	6	14
32	Bell Tone	32	11111	Bell Tone		96	101	12	25

Il controllo del volume permette una riduzione fino a 20dB. Tutte le frequenze sono nominali.

La colonna EN54-3 mostra i toni certificati CPD.

I livelli sonori EN54-3 indicati sono i minimi SPL nell'intorno del punto più alto negli assi definiti nella EN54-3 quando il volume è al massimo sul modello a base bassa.

**(EN)** Outdoor siren with high acoustic output and low absorption, with a selection of 32 tones.

#### TECHNICAL CHARACTERISTICS

Max. sound power	110 dB at 1 m
Max. consumption	39 mA
Protection rating	IP66 (fixing backplate art. 48SAE001 for IP66 not included)
Power supply voltage	9-30 Vdc
Dimensions	92 mm (diameter) x 95 mm

#### LOW BASE IP45

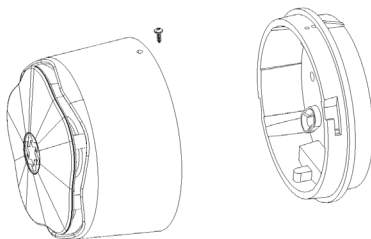

Drill the base for the fixing screws and run the cable either through the base or the pre-drilled holes in the side.

#### HIGH BASE IP66

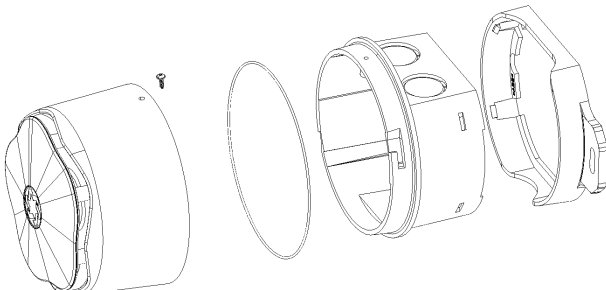

To guarantee the IP66 rating for the device, do not drill the base and use backplate 48SAE001 instead. Use 20 mm cable glands, to be fitted to the relevant preformed parts, and place the seal between the base and the siren body.

#### ELECTRICAL SPECIFICATIONS

Operating voltage	9 – 30 VDC
Not used	Switch 6
Current	See tones table
Operating temperature	- 40°C to +70°C
Synchronisation	Power-on

No	Frequency	2 <sup>nd</sup> Tone	Code 12345	Description	EN54-3 28Vdc see notes	Typ SPL@1m on axis		Typ Current mA	
						12V	24V	12V	24V
1	800Hz to 950Hz swept at 120Hz	4	0000	Banshee Buzz LF		94	101	6	12
2	800Hz to 950Hz swept at 9Hz	4	1000	Banshee Fast Sweep LF	98	94	101	6	12
3	800Hz to 950Hz swept at 3Hz	4	0100	Banshee Slow Sweep LF		94	101	6	12
4	Continuous at 900Hz	4	1100	Banshee Continuous LF		94	101	6	12
5	830Hz to 970Hz swept at 9Hz	4	0010	Banshee Fast Sweep LF (New)		95	101	6	12
6	800Hz to 970Hz swept at 1Hz	7	1010	Medium Sweep LF	98	96	101	6	12
7	Continuous at 950Hz	7	0110	Continuous LF		96	102	6	13
8	Intermittent at 950Hz 1 sec on, 1 sec off	4	1110	Back Up Alarm LF		96	102	8	14
9	Alternating 800Hz/1000Hz at 1Hz	4	0001	Alternate LF		94	100	6	13
10	800Hz to 1000Hz swept at 0.5 secs	4	1001	Medium Sweep LF		95	101	6	12
11	Alternating Tones 800/950Hz at 3Hz	4	0101	Alternate LF		96	101	6	12
12	2400Hz to 2900Hz at 120Hz	15	1101	Banshee Buzz HF		102	110	16	35
13	2400Hz to 2900Hz at 9Hz	15	0011	Banshee Fast Sweep HF		103	110	17	35
14	2400Hz to 2900Hz at 3Hz	15	1011	Banshee Slow Sweep HF		103	110	17	35
15	Continuous 2900Hz	15	0111	Banshee Continuous HF		103	110	19	39
16	2450Hz to 3100Hz swept at 9Hz	15	1111	Banshee Fast Sweep HF (New)		103	110	18	36
17	Intermittent at 2900Hz 1 sec on, 1 sec off	15	0001	Back Up Alarm HF		104	110	18	36
18	Alternating Tones 2400/2900 at 3Hz	15	1001	Alternate HF		104	110	16	36
19	500Hz rising to 1200Hz over 3.5 sec, silence 0.5 sec	4	01001	Slow Whoop	98	95	101	6	12
20	1200Hz falling to 500Hz over 1 sec, silence 10mS	4	11001	Din Tone (DK)	97	93	100	5	10
21	554Hz for 100mS and 440Hz for 400mS	4	00101	French Fire Sounder	93	90	96	4	7
22	420Hz repeating 0.625 sec on, 0.625 sec off	4	10101	Australian Alert Signal		89	95	3	6
23	500Hz to 1200Hz sweeping, 3.75 secs on, 0.25 secs off	4	01101	Australian Evacuation Signal		95	103	6	12
24	950Hz for 0.5 sec on, 0.5 sec off for 3 phases, silence for 1.5 secs	4	11101	US Temporal Tone LF		95	101	5	10
25	2900Hz for 0.5sec on, 0.5sec off for 3 phases, silence for 1.5 sec	15	00011	US Temporal Tone HF		104	110	13	26
26	Intermittent 660Hz 150mS on, 150mS off	26	10011	Swedish Tone (Fire)		90	96	3	6
27	Continuous 660Hz	27	01011	Swedish Tone (All Clear)		91	97	5	9
28	Intermittent 970Hz 500mS on, 500mS off	28	11011	ISO8201 LF		93	99	5	10
29	Intermittent 2900Hz 500mS on, 500mS off	29	00111	ISO8201 HF		103	110	13	27
30	Yodel 800Hz/1000Hz, 0.25sec	31	10111	BT Banshee (FP1063,1)		93	100	6	12
31	Continuous 1000Hz	31	01111	BT Banshee (FP1063,1)		90	96	6	14
32	Bell Tone	32	11111	Bell Tone		96	101	12	25

Volume control allows a decrease of up to 20 dB. All frequencies are rated values.

Column EN54-3 lists CPD approved tones.

The EN54-3 sound levels indicated are SPL minimum values around the highest point of the axes defined in EN54-3 when the volume is at maximum in the low base model.

**(FR)** Sirène d'extérieur à rendement sonore élevé et faible absorption, 32 tonalités sélectionnables.

#### CARACTÉRISTIQUES TECHNIQUES

Puissance sonore max.	110 dB à 1 m
Consommation max.	39 mA
Indice de protection	IP66 (étrier de fixation art.48SAE001 pour indice IP66 non inclus)
Tension d'alimentation	9-30 Vdc
Dimensions	92 mm (diamètre) x 95 mm

#### BASE BASSE IP45

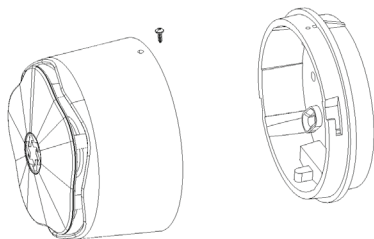

Percer le fond de la base pour les vis de fixation, faire passer le câble à travers le fond ou à travers les fentes latérales prédécoupées.

#### BASE HAUTE IP66

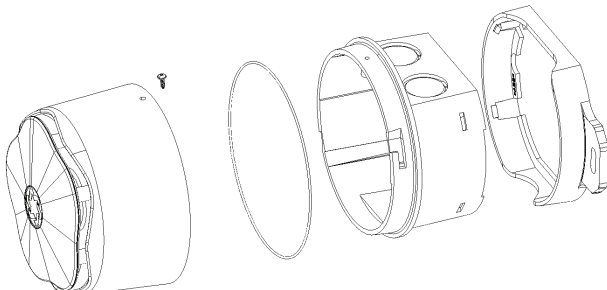

Pour garantir l'indice IP66 du dispositif, ne pas percer la base et utiliser l'étrier 48SAE001.

Utiliser des serre-câbles de 20 mm et les monter sur les ouvertures prédécoupées, insérer le joint entre la base et le corps de la sirène.

#### CARACTÉRISTIQUES ÉLECTRIQUES

Tension de service	9 – 30 Vdc
Libre	Switch 6
Courant	Voir tableau des tonalités
Température de fonctionnement	de - 40 °C à + 70 °C
Synchronisation	Allumage

N°	Fréquence	2° tonalité	Code 12345	Description	EN54-3 28 Vdc voir remarques	Typ SPL@1m sur l'axe		Typ Corrent mA	
						12V	24V	12V	24V
1	800Hz to 950Hz swept at 120Hz	4	0000	Banshee Buzz LF		94	101	6	12
2	800Hz to 950Hz swept at 9Hz	4	1000	Banshee Fast Sweep LF	98	94	101	6	12
3	800Hz to 950Hz swept at 3Hz	4	01000	Banshee Slow Sweep LF		94	101	6	12
4	Continuous at 900Hz	4	11000	Banshee Continuous LF		94	101	6	12
5	830Hz to 970Hz swept at 9Hz	4	00100	Banshee Fast Sweep LF (New)		95	101	6	12
6	800Hz to 970Hz swept at 1Hz	7	10100	Medium Sweep LF	98	96	101	6	12
7	Continuous at 950Hz	7	01100	Continuous LF		96	102	6	13
8	Intermittent at 950Hz 1 sec on, 1 sec off	4	11100	Back Up Alarm LF		96	102	8	14
9	Alternating 800Hz/1000Hz at 1Hz	4	00010	Alternate LF		94	100	6	13
10	800Hz to 1000Hz swept at 0.5 secs	4	10010	Medium Sweep LF		95	101	6	12
11	Alternating Tones 800/950Hz at 3Hz	4	01010	Alternate LF		96	101	6	12
12	2400Hz to 2900Hz at 120Hz	15	11010	Banshee Buzz HF		102	110	16	35
13	2400Hz to 2900Hz at 9Hz	15	00110	Banshee Fast Sweep HF		103	110	17	35
14	2400Hz to 2900Hz at 3Hz	15	10110	Banshee Slow Sweep HF		103	110	17	35
15	Continuous 2900Hz	15	01110	Banshee Continuous HF		103	110	19	39
16	2450Hz to 3100Hz swept at 9Hz	15	11110	Banshee Fast Sweep HF (New)		103	110	18	36
17	Intermittent at 2900Hz 1 sec on, 1 sec off	15	00001	Back Up Alarm HF		104	110	18	36
18	Alternating Tones 2400/2900 at 3Hz	15	10001	Alternate HF		104	110	16	36
19	500Hz rising to 1200Hz over 3.5 sec, silence 0.5 sec	4	01001	Slow Whoop	98	95	101	6	12
20	1200Hz falling to 500Hz over 1 sec, silence 10mS	4	11001	Din Tone (DK)	97	93	100	5	10
21	554Hz for 100mS and 440Hz for 400mS	4	00101	French Fire Sounder	93	90	96	4	7
22	420Hz repeating 0.625 sec on, 0.625 sec off	4	10101	Australian Alert Signal		89	95	3	6
23	500Hz to 1200Hz sweeping, 3.75 secs on, 0.25 secs off	4	01101	Australian Evacuation Signal		95	103	6	12
24	950Hz for 0.5 sec on, 0.5 sec off for 3 phases, silence for 1.5 secs	4	11101	US Temporal Tone LF		95	101	5	10
25	2900Hz for 0.5sec on, 0.5sec off for 3 phases, silence for 1.5 sec	15	00011	US Temporal Tone HF		104	110	13	26
26	Intermittent 660Hz 150mS on, 150mS off	26	10011	Swedish Tone (Fire)		90	96	3	6
27	Continuous 660Hz	27	01011	Swedish Tone (All Clear)		91	97	5	9
28	Intermittent 970Hz 500mS on, 500mS off	28	11011	ISO8201 LF		93	99	5	10
29	Intermittent 2900Hz 500mS on, 500mS off	29	00111	ISO8201 HF		103	110	13	27
30	Yodel 800Hz/1000Hz, 0.25sec	31	10111	BT Banshee (FP1063,1)		93	100	6	12
31	Continuous 1000Hz	31	01111	BT Banshee (FP1063,1)		90	96	6	14
32	Bell Tone	32	11111	Bell Tone		96	101	12	25

Le contrôle du volume assure une réduction de 20 dB. Toutes les fréquences sont nominales.

La colonne EN54-3 indique les tonalités certifiées CPD.

Les niveaux sonores EN54-3 indiqués correspondent aux valeurs minimales SPL autour du point le plus haut des axes définis pour EN54-3 lorsque le volume est au maximum sur le modèle avec base basse.

**NL** Buitensirene met hoge geluidskwaliteit en laag stroomverbruik met 32 selecteerbare tonen.

#### TECHNISCHE SPECIFICATIES

Geluidsvermogen max.	110 dB op 1m
Max. verbruik	39mA
Beschermingsklasse	IP66 (exclusief muurplaat art. 48SAE001 voor klasse IP66)
Voedingsspanning	9-30 Vdc
Afmetingen	92mm (diameter) x 95mm

#### LAGE SOKKEL IP45

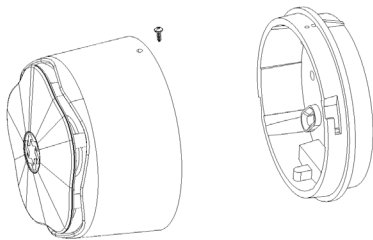

Doorboor de bodem van de sokkel ten behoeve van de bevestigingsschroeven, voer de kabel ofwel door de bodem of door de bestaande gaten in de zijkant.

#### HOGE SOKKEL IP66

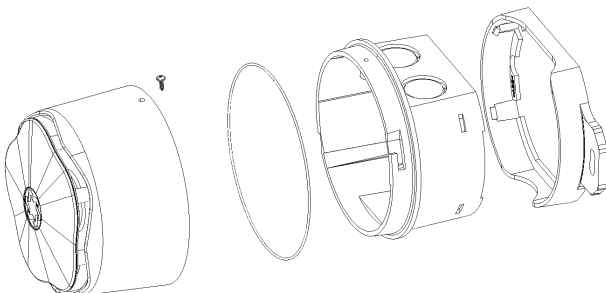

Om de beschermingsgraad IP66 van het apparaat te garanderen, mag de sokkel niet worden doorboord en moet de muurplaat 48SAE001 worden gebruikt.

Gebruik kabelklemmen van 20 mm die op de overeenkomstige voorg gevormde rondjes moeten worden gemonteerd en breng de pakking aan tussen de sokkel en de sirenebehuizing.

#### ELEKTRISCHE SPECIFICATIES

Bedrijfsspanning	9 – 30 VDC
Niet in gebruik	Switch 6
Stroom	Zie tonen-tabel
Temperatuurbereik	- 40° C tot + 70°C
Synchronisatie	Aan

Nee	Frequentie	2 <sup>o</sup> Toon	Code 12345	Beschrijving	EN54-3 28Vdc		Typ SPL@1m op de as		Type stroom mA	
					Zie opmerkingen		12V	24V	12V	24V
1	800Hz to 950Hz swept at 120Hz	4	0000	Banshee Buzz LF			94	101	6	12
2	800Hz to 950Hz swept at 9Hz	4	1000	Banshee Fast Sweep LF	98		94	101	6	12
3	800Hz to 950Hz swept at 3Hz	4	01000	Banshee Slow Sweep LF			94	101	6	12
4	Continuous at 900Hz	4	11000	Banshee Continuous LF			94	101	6	12
5	830Hz to 970Hz swept at 9Hz	4	00100	Banshee Fast Sweep LF (New)			95	101	6	12
6	800Hz to 970Hz swept at 1Hz	7	10100	Medium Sweep LF	98		96	101	6	12
7	Continuous at 950Hz	7	01100	Continuous LF			96	102	6	13
8	Intermittent at 950Hz 1 sec on, 1 sec off	4	11100	Back Up Alarm LF			96	102	8	14
9	Alternating 800Hz/1000Hz at 1Hz	4	00010	Alternate LF			94	100	6	13
10	800Hz to 1000Hz swept at 0.5 secs	4	10010	Medium Sweep LF			95	101	6	12
11	Alternating Tones 800/950Hz at 3Hz	4	01010	Alternate LF			96	101	6	12
12	2400Hz to 2900Hz at 120Hz	15	11010	Banshee Buzz HF			102	110	16	35
13	2400Hz to 2900Hz at 9Hz	15	00110	Banshee Fast Sweep HF			103	110	17	35
14	2400Hz to 2900Hz at 3Hz	15	10110	Banshee Slow Sweep HF			103	110	17	35
15	Continuous 2900Hz	15	01110	Banshee Continuous HF			103	110	19	39
16	2450Hz to 3100Hz swept at 9Hz	15	11110	Banshee Fast Sweep HF (New)			103	110	18	36
17	Intermittent at 2900Hz 1 sec on, 1 sec off	15	00001	Back Up Alarm HF			104	110	18	36
18	Alternating Tones 2400/2900 at 3Hz	15	10001	Alternate HF			104	110	16	36
19	500Hz rising to 1200Hz over 3.5 sec, silence 0.5 sec	4	01001	Slow Whoop	98		95	101	6	12
20	1200Hz falling to 500Hz over 1 sec, silence 10mS	4	11001	Din Tone (DK)	97		93	100	5	10
21	554Hz for 100mS and 440Hz for 400mS	4	00101	French Fire Sounder	93		90	96	4	7
22	420Hz repeating 0.625 sec on, 0.625 sec off	4	10101	Australian Alert Signal			89	95	3	6
23	500Hz to 1200Hz sweeping, 3.75 secs on, 0.25 secs off	4	01101	Australian Evacuation Signal			95	103	6	12
24	950Hz for 0.5 sec on, 0.5 sec off for 3 phases, silence for 1.5 secs	4	11101	US Temporal Tone LF			95	101	5	10
25	2900Hz for 0.5sec on, 0.5sec off for 3 phases, silence for 1.5 sec	15	00011	US Temporal Tone HF			104	110	13	26
26	Intermittent 660Hz 150mS on, 150mS off	26	10011	Swedish Tone (Fire)			90	96	3	6
27	Continuous 660Hz	27	01011	Swedish Tone (All Clear)			91	97	5	9
28	Intermittent 970Hz 500mS on, 500mS off	28	11011	ISO8201 LF			93	99	5	10
29	Intermittent 2900Hz 500mS on, 500mS off	29	00111	ISO8201 HF			103	110	13	27
30	Yodel 800Hz/1000Hz, 0.25sec	31	10111	BT Banshee (FP1063,1)			93	100	6	12
31	Continuous 1000Hz	31	01111	BT Banshee (FP1063,1)			90	96	6	14
32	Bell Tone	32	11111	Bell Tone			96	101	12	25

De volumeregeling zorgt voor een reductie van maximaal 20dB. Alle frequenties zijn nominaal.

De kolom EN54-3 bevat de conform EN54-3 gecertificeerde tonen.

De aangegeven EN54-3 geluidsniveaus zijn de minimale SPL's bij het hoogste punt op de assen zoals gedefinieerd in EN54-3 bij het hoogste volume bij modellen met lage sokkel.

**(ES)** Sirena de exterior con elevado rendimiento acústico y bajo consumo con 32 tonos seleccionables.

#### CARACTERÍSTICAS TÉCNICAS

Potencia acústica máxima	110 dB a 1 m
Consumo máximo	39 mA
Grado de protección	IP66 (soporte de fijación art. 48SAE001 para grado IP66 no incluido)
Tensión de alimentación	9-30 Vdc
Dimensiones	92mm (diámetro) x 95 mm

#### BASE BAJA IP45

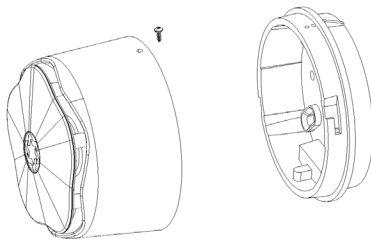

Perforar el fondo de la base para los tornillos de fijación y hacer pasar el cable por el fondo o por los orificios premarcados laterales.

#### BASE ALTA IP66

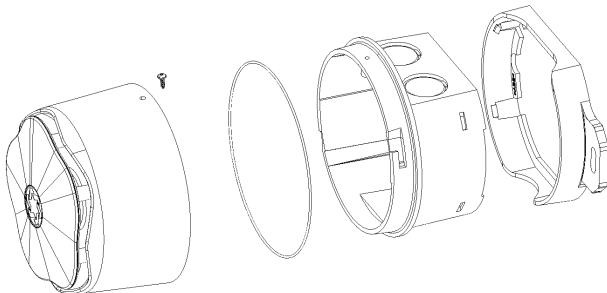

Para garantizar el grado de protección IP66 del dispositivo, no perforar la base y utilizar el soporte 48SAE001.

Usar prensacables de 20 mm, montados en los correspondientes alojamientos, e introducir la junta entre la base y el cuerpo de la sirena.

#### ESPECIFICACIONES ELÉCTRICAS

Tensión de trabajo	9 – 30 Vdc
No se utiliza	Switch 6
Corriente	Véase tabla tonos
Temperatura de funcionamiento	de - 40 °C a + 70 °C
Sincronización	Encendido

No	Frecuencia	2° Tono	Código 12345	Descrizione	EN54-3 28 Vdc Véanse notas	Typ SPL@1m en el eje		Tipo de corriente mA	
						12V	24V	12V	24V
1	800Hz to 950Hz swept at 120Hz	4	0000	Banshee Buzz LF		94	101	6	12
2	800Hz to 950Hz swept at 9Hz	4	1000	Banshee Fast Sweep LF	98	94	101	6	12
3	800Hz to 950Hz swept at 3Hz	4	01000	Banshee Slow Sweep LF		94	101	6	12
4	Continuous at 900Hz	4	11000	Banshee Continuous LF		94	101	6	12
5	830Hz to 970Hz swept at 9Hz	4	00100	Banshee Fast Sweep LF (New)		95	101	6	12
6	800Hz to 970Hz swept at 1Hz	7	10100	Medium Sweep LF	98	96	101	6	12
7	Continuous at 950Hz	7	01100	Continuous LF		96	102	6	13
8	Intermittent at 950Hz 1 sec on, 1 sec off	4	11100	Back Up Alarm LF		96	102	8	14
9	Alternating 800Hz/1000Hz at 1Hz	4	00010	Alternate LF		94	100	6	13
10	800Hz to 1000Hz swept at 0.5 secs	4	10010	Medium Sweep LF		95	101	6	12
11	Alternating Tones 800/950Hz at 3Hz	4	01010	Alternate LF		96	101	6	12
12	2400Hz to 2900Hz at 120Hz	15	11010	Banshee Buzz HF		102	110	16	35
13	2400Hz to 2900Hz at 9Hz	15	00110	Banshee Fast Sweep HF		103	110	17	35
14	2400Hz to 2900Hz at 3Hz	15	10110	Banshee Slow Sweep HF		103	110	17	35
15	Continuous 2900Hz	15	01110	Banshee Continuous HF		103	110	19	39
16	2450Hz to 3100Hz swept at 9Hz	15	11110	Banshee Fast Sweep HF (New)		103	110	18	36
17	Intermittent at 2900Hz 1 sec on, 1 sec off	15	00001	Back Up Alarm HF		104	110	18	36
18	Alternating Tones 2400/2900 at 3Hz	15	10001	Alternate HF		104	110	16	36
19	500Hz rising to 1200Hz over 3.5 sec, silence 0.5 sec	4	01001	Slow Whoop	98	95	101	6	12
20	1200Hz falling to 500Hz over 1 sec, silence 10mS	4	11001	Din Tone (DK)	97	93	100	5	10
21	554Hz for 100mS and 440Hz for 400mS	4	00101	French Fire Sounder	93	90	96	4	7
22	420Hz repeating 0.625 sec on, 0.625 sec off	4	10101	Australian Alert Signal		89	95	3	6
23	500Hz to 1200Hz sweeping, 3.75 secs on, 0.25 secs off	4	01101	Australian Evacuation Signal		95	103	6	12
24	950Hz for 0.5 sec on, 0.5 sec off for 3 phases, silence for 1.5 secs	4	11101	US Temporal Tone LF		95	101	5	10
25	2900Hz for 0.5sec on, 0.5sec off for 3 phases, silence for 1.5 sec	15	00011	US Temporal Tone HF		104	110	13	26
26	Intermittent 660Hz 150mS on, 150mS off	26	10011	Swedish Tone (Fire)		90	96	3	6
27	Continuous 660Hz	27	01011	Swedish Tone (All Clear)		91	97	5	9
28	Intermittent 970Hz 500mS on, 500mS off	28	11011	ISO8201 LF		93	99	5	10
29	Intermittent 2900Hz 500mS on, 500mS off	29	00111	ISO8201 HF		103	110	13	27
30	Yodel 800Hz/1000Hz, 0.25sec	31	10111	BT Banshee (FP1063,1)		93	100	6	12
31	Continuous 1000Hz	31	01111	BT Banshee (FP1063,1)		90	96	6	14
32	Bell Tone	32	11111	Bell Tone		96	101	12	25

El control del volumen permite una reducción hasta 20 dB. Todas las frecuencias son nominales.

En la columna EN54-3 se indican los tonos certificados CPD.

Los niveles sonoros EN54-3 indicados son los mínimos SPL alrededor del punto más alto en los ejes definidos en dicha norma cuando el volumen está al máximo en el modelo de base baja.

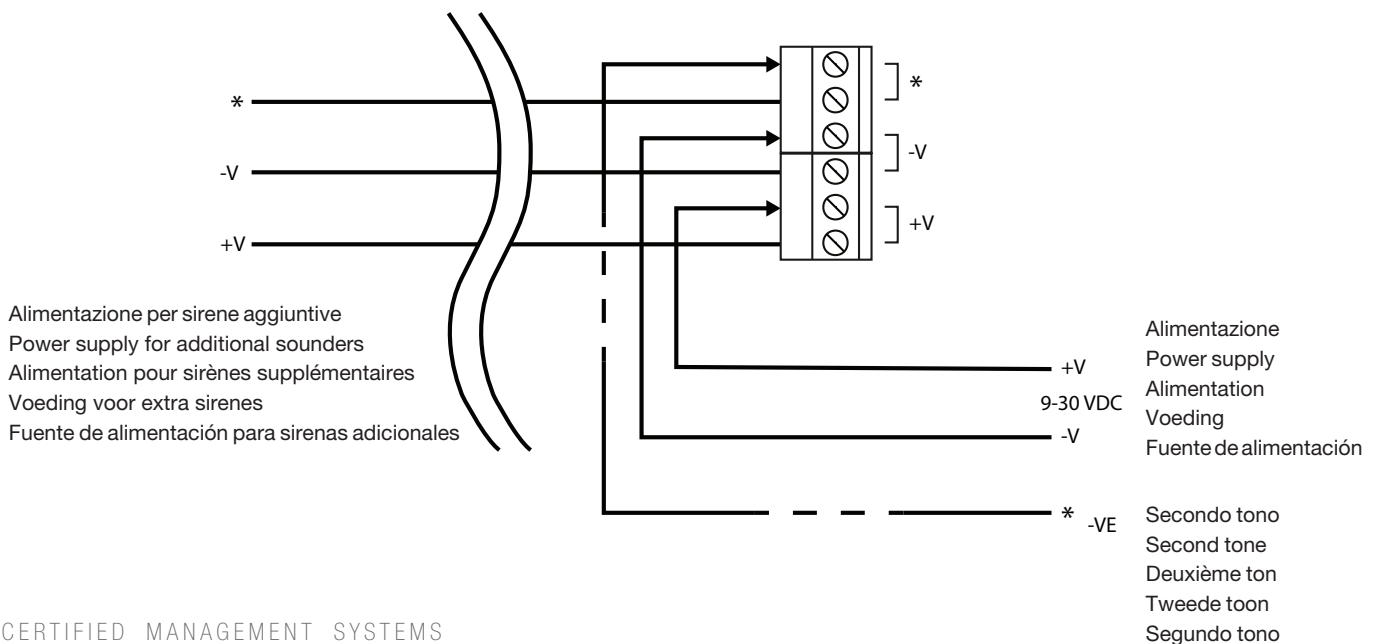
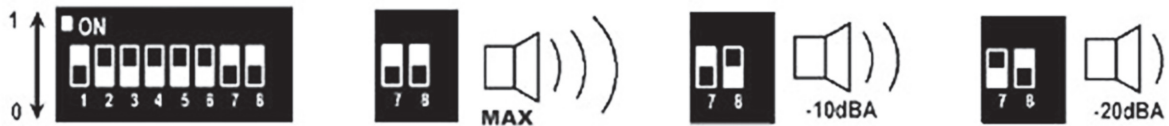

CERTIFIED MANAGEMENT SYSTEMS



www.comelitgroup.com

Via Don Arrigoni, 5 - 24020 Rovetta (BG) - Italy



2ª edizione 11/2021  
cod. 2G40002215