

## Data Sheet | Item Number: 262-314

2-conductor terminal block; without push-buttons; suitable for Ex i applications; with snap-in mounting foot; 1-pole; for plate thickness 0.6 - 1.2 mm; Fixing hole 3.5 mm Ø; 4 mm<sup>2</sup>; CAGE CLAMP®; 4,00 mm<sup>2</sup>; blue

<https://www.wago.com/262-314>

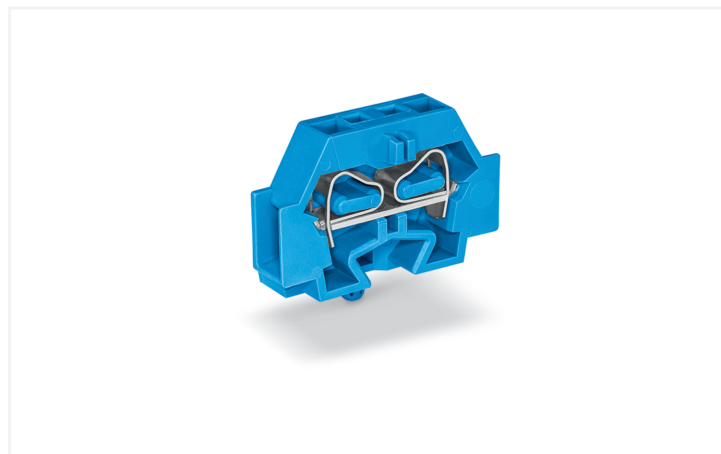
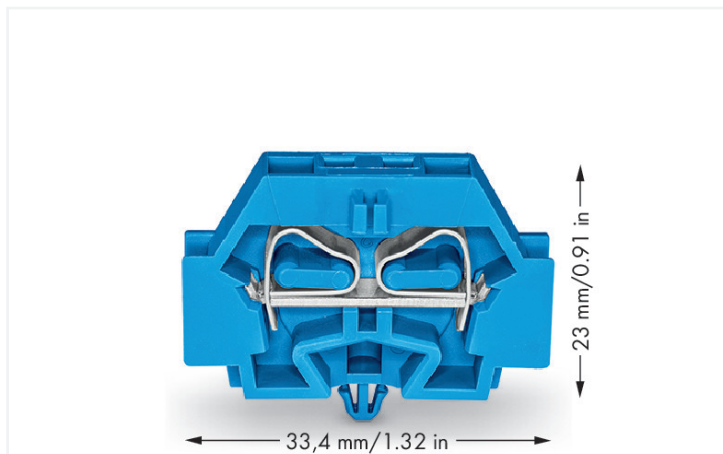

Color: ■ blue

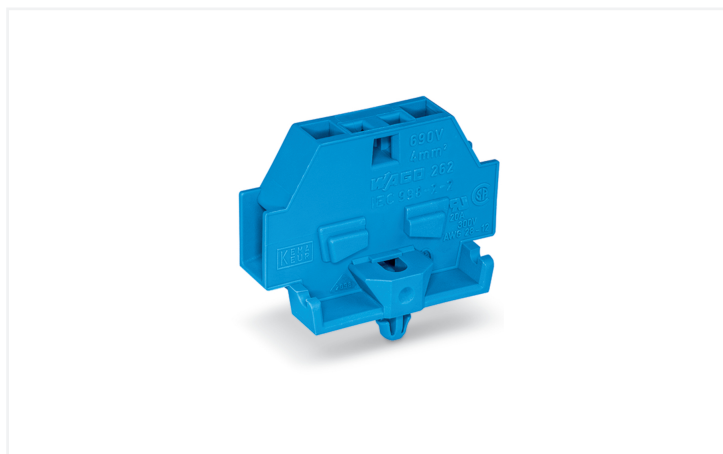

Through terminal block, 262 Series, blue

Easily, quickly and safely connect conductors with this through terminal block (item number 262-314). Strip lengths must be between 9 and 10 mm when connecting conductors to this through terminal block. Our mini rail-mount terminal blocks are the perfect choice when space is limited. A large selection of mounting and actuation variants means you can find a suitable mini terminal block for every purpose. This also means you can adapt the terminal blocks to your unique requirements. This product features conductor terminals and utilizes CAGE CLAMP®. Our reliable and maintenance-free CAGE CLAMP® connection makes it easy to connect all types of conductors without having to prepare the conductor. For example, you don't need to crimp ferrules. Dimensions: (7 x 33.4 x 27.5) mm (width x height x depth). Depending on the type of conductor, this through terminal block is suitable for conductor cross sections ranging from 0.08 mm<sup>2</sup> to 4 mm<sup>2</sup>.

This mini rail-mount terminal block is operated with an operating tool.

## Electrical data

### Ratings per IEC/EN

Nominal voltage (III/3)	690 V
Rated impulse withstand voltage (III / 3)	8 kV
Rated current	32 A
Legend (ratings)	(III / 3) $\triangleq$ Overvoltage category III / Pollution degree 3

### Approvals per

### UL 1059

Use group	B	C	D
Rated voltage	300 V	300 V	300 V
Rated current	20 A	20 A	10 A

### Approvals per

### CSA 22.2 No 158

Use group	B	C	D
Rated voltage	600 V	300 V	600 V
Rated current	5 A	25 A	5 A

### General information

Wiring direction	Side-entry wiring
------------------	-------------------

## Connection Data

Clamping units	2
Total number of potentials	1
Number of levels	1

### Connection 1

Connection technology	CAGE CLAMP®
Actuation type	Operating tool
Connectable conductor materials	Copper
Solid conductor	0.08 ... 4 mm <sup>2</sup> / 28 ... 12 AWG
Fine-stranded conductor	0.08 ... 4 mm <sup>2</sup> / 28 ... 12 AWG
Strip length	9 ... 10 mm / 0.35 ... 0.39 inches
Wiring direction	Side-entry wiring

## Physical data

Width	7 mm / 0.276 inches
Height	33.4 mm / 1.315 inches
Height from the surface	23.1 mm / 0.909 inches
Depth	27.5 mm / 1.083 inches

## Mechanical data

Design	horizontal type
Mounting type	Snap-in foot
Marking level	Side marking

## Material data

Note (material data)	<a href="#">Information on material specifications can be found here</a>
Color	blue
Material group	I
Insulation material (main housing)	Polyamide (PA66)
Flammability class per UL94	V0
Fire load	0.077 MJ
Halogen-free	Yes
Weight	4.2 g

### Environmental requirements

Processing temperature	-35 ... +85 °C
Continuous operating temperature	-60 ... +105 °C

### Commercial data

Product Group	9 (Std Chassis Mt Blocks)
PU (SPU)	100 (50) pcs
Packaging type	Box
Country of origin	CN
GTIN	4044918639767
Customs tariff number	85369010000

### Product Classification

UNSPSC	39121410
eCl@ss 10.0	27-14-11-06
eCl@ss 9.0	27-14-11-06
ETIM 9.0	EC001284
ETIM 10.0	EC001284
ECCN	NO US CLASSIFICATION

### Environmental Product Compliance

RoHS Compliance Status	Compliant, No Exemption
------------------------	-------------------------

### Approvals / Certificates

#### General approvals



Approval	Standard	Certificate Name
CCA DEKRA Certification B.V.	EN 60998	NTR NL 7661
CSA DEKRA Certification B.V.	C22.2	70010891
KEMA/KEUR DEKRA Certification B.V.	EN 60998	71-102644
UR Underwriters Laboratories Inc.	UL 1059	E45172

#### Declarations of conformity and manufacturer's declarations

Approval	Standard	Certificate Name
EU-Declaration of Conformity WAGO GmbH & Co. KG	-	-
UK-Declaration of Conformity WAGO GmbH & Co. KG	-	-

#### Approvals for marine applications



Approval	Standard	Certificate Name
ABS American Bureau of Shipping	-	24-0095979-PDA
BV Bureau Veritas S.A.	EN 60947	07436/G0 BV
DNV GL Det Norske Veritas, Germanischer Lloyd	-	TAE00001V2
LR Lloyds Register	IEC 60998	LR22173030TA

#### Approvals for marine applications

PRS Polski Rejestr Statków	-	TE/1094/880590/23
-------------------------------	---	-------------------

## Downloads

### Environmental Product Compliance

#### Compliance Search

Environmental Product Compliance 262-314



## Documentation

### Bid Text

262-314	19.02.2019	xml 3.30 KB	
262-314	17.08.2017	doc 25.00 KB	

## CAD/CAE-Data

### CAD data

2D/3D Models 262-314



### CAE data

EPLAN Data Portal 262-314



WSCAD Universe 262-314



ZUKEN Portal 262-314



## 1 Compatible Products

### 1.1 Required Accessories

#### 1.1.1 End plate

##### 1.1.1.1 End plate



[Item No.: 262-371](#)

End plate; with snap-in mounting foot; gray

### 1.2 Optional Accessories

#### 1.2.1 DIN-rail

##### 1.2.1.1 Mounting accessories



[Item No.: 210-154](#)

Aluminum carrier rail; 1000 mm long; 18 mm wide; 7 mm high; silver-colored

## 1.2.2 Ferrule

### 1.2.2.1 Ferrule



**Item No.: 216-131**

Ferrule; Sleeve for 0.25 mm<sup>2</sup> / AWG 24; uninsulated; electro-tin plated; silver-colored

**Item No.: 216-241**

Ferrule; Sleeve for 0.5 mm<sup>2</sup> / 20 AWG; insulated; electro-tin plated; electrolytic copper; gastight crimped; acc. to DIN 46228, Part 4/09.90; white

**Item No.: 216-141**

Ferrule; Sleeve for 0.5 mm<sup>2</sup> / 20 AWG; uninsulated; electro-tin plated; electrolytic copper; gastight crimped; acc. to DIN 46228, Part 1/08.92

**Item No.: 216-242**

Ferrule; Sleeve for 0.75 mm<sup>2</sup> / 18 AWG; insulated; electro-tin plated; electrolytic copper; gastight crimped; acc. to DIN 46228, Part 4/09.90; gray



**Item No.: 216-262**

Ferrule; Sleeve for 0.75 mm<sup>2</sup> / 18 AWG; insulated; electro-tin plated; electrolytic copper; gastight crimped; acc. to DIN 46228, Part 4/09.90; gray

**Item No.: 216-142**

Ferrule; Sleeve for 0.75 mm<sup>2</sup> / 18 AWG; uninsulated; electro-tin plated; electrolytic copper; gastight crimped; acc. to DIN 46228, Part 1/08.92

**Item No.: 216-243**

Ferrule; Sleeve for 1 mm<sup>2</sup> / AWG 18; insulated; electro-tin plated; electrolytic copper; gastight crimped; acc. to DIN 46228, Part 4/09.90; red

**Item No.: 216-263**

Ferrule; Sleeve for 1 mm<sup>2</sup> / AWG 18; insulated; electro-tin plated; electrolytic copper; gastight crimped; acc. to DIN 46228, Part 4/09.90; red



**Item No.: 216-143**

Ferrule; Sleeve for 1 mm<sup>2</sup> / AWG 18; uninsulated; electro-tin plated; electrolytic copper; gastight crimped; acc. to DIN 46228, Part 1/08.92

**Item No.: 216-244**

Ferrule; Sleeve for 1.5 mm<sup>2</sup> / AWG 16; insulated; electro-tin plated; electrolytic copper; gastight crimped; acc. to DIN 46228, Part 4/09.90; black

**Item No.: 216-264**

Ferrule; Sleeve for 1.5 mm<sup>2</sup> / AWG 16; insulated; electro-tin plated; electrolytic copper; gastight crimped; acc. to DIN 46228, Part 4/09.90; black

**Item No.: 216-284**

Ferrule; Sleeve for 1.5 mm<sup>2</sup> / AWG 16; insulated; electro-tin plated; electrolytic copper; gastight crimped; acc. to DIN 46228, Part 4/09.90; black



**Item No.: 216-144**

Ferrule; Sleeve for 1.5 mm<sup>2</sup> / AWG 16; uninsulated; electro-tin plated; electrolytic copper; gastight crimped; acc. to DIN 46228, Part 1/08.92; silver-colored

**Item No.: 216-289**

Ferrule; Sleeve for 10 mm<sup>2</sup> / AWG 8; insulated; electro-tin plated; electrolytic copper; gastight crimped; acc. to DIN 46228, Part 4/09.90; red

**Item No.: 216-209**

Ferrule; Sleeve for 10 mm<sup>2</sup> / AWG 8; uninsulated; electro-tin plated; red

**Item No.: 216-109**

Ferrule; Sleeve for 10 mm<sup>2</sup> / AWG 8; uninsulated; electro-tin plated



**Item No.: 216-210**

Ferrule; Sleeve for 16 mm<sup>2</sup> / AWG 6; insulated; electro-tin plated; electrolytic copper; gastight crimped; acc. to DIN 46228, Part 4/09.90; blue

**Item No.: 216-110**

Ferrule; Sleeve for 16 mm<sup>2</sup> / AWG 6; uninsulated; electro-tin plated; brown metallic

**Item No.: 216-246**

Ferrule; Sleeve for 2.5 mm<sup>2</sup> / AWG 14; insulated; electro-tin plated; electrolytic copper; gastight crimped; acc. to DIN 46228, Part 4/09.90; blue

**Item No.: 216-266**

Ferrule; Sleeve for 2.5 mm<sup>2</sup> / AWG 14; insulated; electro-tin plated; electrolytic copper; gastight crimped; acc. to DIN 46228, Part 4/09.90; blue



**Item No.: 216-286**

Ferrule; Sleeve for 2.5 mm<sup>2</sup> / AWG 14; insulated; electro-tin plated; electrolytic copper; gastight crimped; acc. to DIN 46228, Part 4/09.90; blue

**Item No.: 216-267**

Ferrule; Sleeve for 4 mm<sup>2</sup> / AWG 12; insulated; electro-tin plated; electrolytic copper; gastight crimped; acc. to DIN 46228, Part 4/09.90; gray

**Item No.: 216-287**

Ferrule; Sleeve for 4 mm<sup>2</sup> / AWG 12; insulated; electro-tin plated; electrolytic copper; gastight crimped; acc. to DIN 46228, Part 4/09.90; gray

**Item No.: 216-208**

Ferrule; Sleeve for 6 mm<sup>2</sup> / AWG 10; insulated; electro-tin plated; electrolytic copper; gastight crimped; acc. to DIN 46228, Part 4/09.90; yellow



**Item No.: 216-288**

Ferrule; Sleeve for 6 mm<sup>2</sup> / AWG 10; insulated; electro-tin plated; electrolytic copper; gastight crimped; acc. to DIN 46228, Part 4/09.90; yellow

**Item No.: 216-108**

Ferrule; Sleeve for 6 mm<sup>2</sup> / AWG 10; uninsulated; electro-tin plated; silver-colored

## 1.2.3 Installation

### 1.2.3.1 Mounting accessories



**Item No.: 209-137**

Mounting adapter; can be used as end stop; 6.5 mm wide; gray

**Item No.: 209-120**

Mounting foot; can be snapped on terminal blocks with snap-in mounting foot; for mounting on relay-modules; 6.4 mm wide; gray

## 1.2.4 Jumper

### 1.2.4.1 Jumper



**Item No.: 262-402**

Jumper; for conductor entry; 2-way; insulated; gray

## 1.2.5 Marking

### 1.2.5.1 Marking strip



**Item No.: 210-833**

Marking strips; 25 m on roll; 6 mm wide; plain; Self-adhesive; white

## 1.2.6 Test and measurement

### 1.2.6.1 Testing accessories



**Item No.: 249-137**

Test plug module; without locking device; modular; for 2-conductor terminal blocks; gray

## 1.2.7 Tool

### 1.2.7.1 Operating tool



**Item No.: 210-658**

Operating tool; Blade: 3.5 x 0.5 mm; with a partially insulated shaft; angled; short; multicoloured



**Item No.: 210-720**

Operating tool; Blade: 3.5 x 0.5 mm; with a partially insulated shaft; multicoloured



**Item No.: 210-657**

Operating tool; Blade: 3.5 x 0.5 mm; with a partially insulated shaft; short; multicoloured

## Installation Notes

### Installation

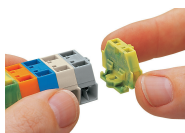

Assembling modular terminal blocks into terminal strips.

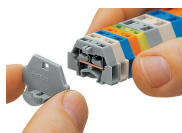

Mounting an end plate.

## Conductor termination

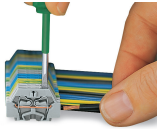

### CAGE CLAMP® connection

Inserting a conductor.

With ferruled conductors, it is necessary to use a terminal block one size larger than the conductor's nominal cross-section.

## Commoning

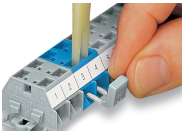

Commoning with comb-style jumper bar.

## Marking



Marking with self-adhesive marking strips.



Marking by direct printing (upon request).